

GENERAL CATALOGUE 2017



MEASURING INSTRUMENTS AND INTEGRATED SYSTEMS



INDEX



2	GENERAL CARATTERISTIC
8	MULTIFUNCTION METERS NEMO
40	STATIC ENERGY METERS CONTO
61	SOFTWARE AND INTERFACES
66	LOW VOLTAGE TRANSFORMERS
110	RESIDUAL CURRENT DEVICE DELTA
128	INSULATION MONITOR ISO
138	TRANSDUCERS
158	DIGITAL INDICATORS
170	ANALOGUE INDICATORS

COMPANY

“ IME since **1946** designs
and **manufactures** measuring
instruments and integrated **systems**. ”



IME develop solutions to control the main electrical parameters, with an eye towards topics such as energy efficiency, renewable energies and management energy.

An offer suitable for all applications with instruments providing the best performance levels in terms of measure, protection and management.

▶ **measure**

a complete range of digital and analog measurement

- Multifunctions meters
- Static energy meters
- Analog and digital meters
- Current and voltage transformers
- Transducers



▶ **protection**

circuits protection solutions

- Residual current relay
- Insulation relay for medical use
- Insulation transformers for medical use



▶ **energy management**

solution to monitor the energy in the electrical distribution

- RS232/RS485/Ethernet interfaces
- Radio 868MHz interfaces
- Pulse concentrator
- Power management relay
- Management software



WEBSITE

all information
all documentation



www.imeitaly.com



→ IN THE **IME** WEBSITE YOU CAN:

- ▶ **see** a complete product range
- ▶ **download**, Technical Documentation, Technical Guide, management Software, Firmware, catalogue
- ▶ **discover** the news about product and events
- ▶ **find** all technical notes about products (NTcode)

NT742
0,01A
0,5A
5A
6A
20I _{max} /0,5s
0,3W / 0,2VA for phase
100V and 400V ± 15%

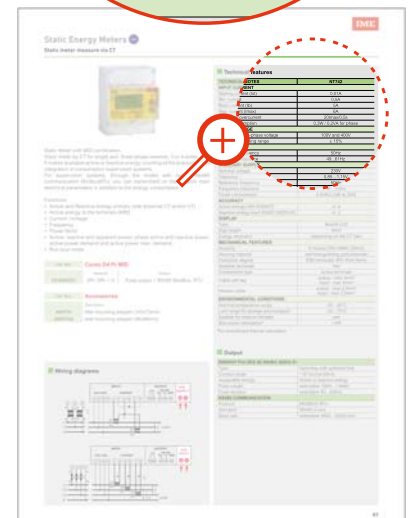

RANGE



MULTIFUNCTION METERS NEMO



STATIC ENERGY METERS CONTO



SOFTWARE AND INTERFACES



LOW VOLTAGE TRANSFORMERS



RESIDUAL CURRENT RELAIS DELTA



INSULATION RELAIS ISO



TRANSDUCERS TEMA



DIGITAL INDICATORS



ANALOGUE INDICATORS



MULTIFUNCTION METERS

NEMO



▶ NEW ◀

New first level range of multifunction NEMO available in modular and flush mounting version, and NEW NEMO 96 HD+ with integrated harmonic measure



NEMO D4-e



NEMO 96HD-e



NEMO 96 HD+

▶ **NEMO** is a range of multifunction instruments for monitoring of the main electrical parameters. The multifunction meters are available on modular and flush mounting version. The NEMO 96 can be equipped by additional modules with many communication functions.



Measures

Simultaneously all the parameters of the electrical network, such as voltages, currents, frequency, power factor, active, reactive and apparent power.

Analysis

The quality of the supply by computing the single harmonics of current and voltage.

Warning

Abnormal events by alarm relays activation, in field programmed.

Comply

With the technical characteristics of the installation thanks to its in field programming mode of the electrical network (single phase or three phase 3/4 wires) and of CT's and VT's ratios.

Transmit

To a remote controller the data and the configuration of the device, through RS232 or RS485 or by pulse outputs. It is compatible with ModBus RTU, Profibus, M-Bus, LonWorks, BACnet and Ethernet networks.

Counting

Active and reactive energy.
Run hours.

Computing

Average and max current.
Average and max power.

Display

All the electrical parameters on a backlit LED screen, easily accessed by keyboard.

Multifunction meters

Selection table

Model		NEMO D4-b	NEMO D4-e	NEMO D4-Le	NEMO D4-L+	NEMO D4-Dc	
Network		LV	LV	LV	LV/MV	DC	
Installation		DIN rail					
Technical notes		NT588	NT901	NT864	NT695	NT753	
INPUT	Connection	1Ph	•	•	•	•	
		3Ph balanced load		•	•	•	
		3Ph unbalanced load	•	•	•	•	
	Phase sequence correction, diagnostic			•	•		
	Rated value	Voltage	80...480V	80...500V	80...500V	80...480V	10...300V 50... 1500V
		Current	1 - 5A	5A	1 + 5A	1 + 5A	10A shunt 60-100-150mV
	Input current	Dedicated CT	•	•	•		
		Insulated				•	
	Programmable Ratio	Insulated		1...10	1...10	1...400	
			CT	Ranges	41...(5...8000A)		
		Isn		1...9'999	1...9'999	1...9'999	
		Max. kVT x kCT		99'990	99'990	100.000(5A) 400.000(1A)	
	Shunt					1...9999	
DISPLAY	Active energy	Accuracy EN/IEC 61557-12		cl.1	cl.0,5	cl.1	
		Energy dc accuracy				cl.1	
		Positive, total and partial		•	•	•	•
		Negative, total		•	•	•	•
	Reactive energy	Accuracy EN/IEC 61557-12		cl.1	cl.1	cl.2	
		Positive, total		•	•	•	
		Positive, partial		•	•	•	
	Voltage	Negative, totale		•	•	•	
		Phase and linked	•	•	•	•	
		Phase and neutral	•	•	•	•	
	Current	Neutral (measured)		•			
		Phase demand and max. Demand	•	•	•	•	
		Positive and negative Ah					•
	Power factor	Threee-phase	•	•	•	•	
		Phase		•	•		
	Power	Active,reactive, apparent	•	•	•	•	
		Demand and max. Demand	•	•	•	•	•
		Phase active and reactive	•	•	•	•	
	Harmonic distortion	Thd current / voltage		•	•	•	
		Analysis			•		
Frequency		•	•	•	•		
D.C.1 Measure						•	
Run hour meter		•	•	•	•	•	
Wrong phase sequence			•	•	•		
Temperature							
OUTPUT	Pulse		•	•	•	•	
	Alarm relays					•	
	Alarm relays + digital inputs			•			
	Analogue						
COMMUNICATION	RS232						
	RS485 Modbus RTU		•	•	•	•	
	RS485 + Memory						
	Profibus						
	Lonworks						
	M-bus						
	Bacnet			•	•		
	Ethernet		• ¹	• ¹	• ¹	• ¹	
868Mhz radio trasmission							

¹ RS485 version + external interface (IF2E or IF4E)

Multifunction meters

Multifunction for low voltage



Connection via CT for single and three-phase network, 3 or 4-wires.

Functions

- Phase and linked voltage
- Neutral and phase current
- Current demand and current max. demand
- Power demand and power max. demand
- Power factor
- Frequency
- Run hour meter, count start with voltage present

Cat. Nos.	Nemo D4-B			
	Input (A)	Input* (V)	Auxiliary supply	Output
MF6GT00073	5	80...480	115 Vac	-
MF6GT00076	5	80...480	230 Vac	-
MF6GT00079	5	80...480	400 Vac	-
MF6GT00063	1	80...480	115 Vac	-
MF6GT00066	1	80...480	230 Vac	-
MF6GT00069	1	80...480	400 Vac	-

* Three-phase input 80...480V, Single-phase input 50...350V

Technical features

TECHNICAL NOTES	NT588
INPUT	
Three-phase voltage (V)	80...480 (phase-phase)
Single-phase voltage (V)	50...350
Current rating	1A - 5A
External CT ratio	5/10/15/20/25/30/40/50/60/70/75/80/100/120/125/150/160/200/250/300/400/500/600/700/750/800/1000/1200/1250/1500/1600/2000/2500/3000/3200/4000/5000/6000/7000/7500/8000A
Continuous overload	1,2In
Istantaneous overload	20Imax/0,5s
Reference frequency	50Hz
Frequency tolerance	47...63Hz
Type of measurement	true RMS
Harmonic content	up to the 16th harmonic
Voltage rated burden (VA)	≤1 (each phase)
Current rated burden (VA)	≤0,5 (each phase)
AUXILIARY SUPPLY	
Rated value Uaux	115 - 230 - 400V
Tolerance	0,85...1,1 Uaux
Reference frequency	50Hz
Frequency tolerance	47...63Hz
Rated burden	≤ 5VA - 2,5W
DISPLAY	
Type of display	LCD backlighted
Digit height	6mm
MECHANICAL FEATURES	
Housing	4 modules DIN 43880 (35mm)
Housing material	self-extinguishing polycarbonate
Protection degree	IP20 terminals/ IP54 front frame
Connections type	screw terminals
Rigid cable	output - max 4mm ² input - max 4mm ²
Flexible cable	output - max 2,5mm ² input - max 2,5mm ²
ENVIRONMENTAL CONDITIONS	
Nominal temperature range	-5...55°C
Limit range for storage and transport	-25...70°C
Suitable for tropical climates	yes
Max.power dissipation*	≤6,8W

* for switchboard thermal calculation

Wiring diagrams

Three-phase network 4-wire

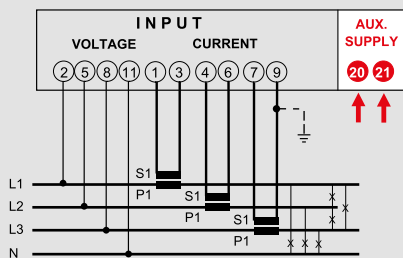

Single-phase network

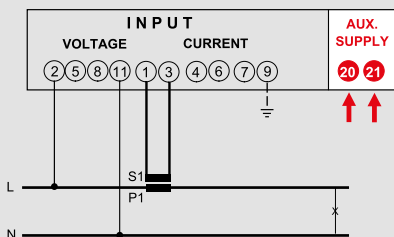

Wiring diagrams

Three-phase network 3-wire (ARON L1-L3)

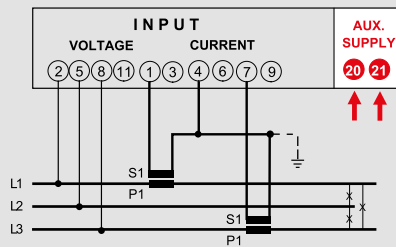

Three-phase network 3-wire (ARON L1-L2)

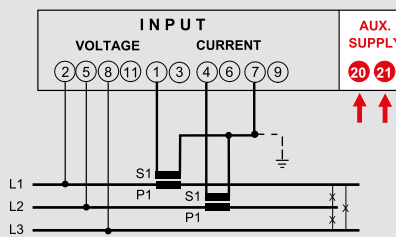

Multifunction meters

KIT Multifunction and CT for low voltage



Connection via dedicated CT for single and three-phase network, 3 or 4-wires.

Functions

- Phase and linked voltage
- Neutral and phase current
- Current demand and current max. demand
- Power demand and power max. demand
- Power factor
- Frequency
- Run hour meter, count start with voltage present

Cat. Nos. **KIT Nemo D4-B + 3 CT (TAIBB model)**

Cat. Nos.	Input (A) /CT (A)	Input (V)	Auxiliary supply	Output
K1NEMOD4B040	5 / 3CT 40/5	80...480	230 Vac	-
K1NEMOD4B050	5 / 3CT 50/5	80...480	230 Vac	-
K1NEMOD4B060	5 / 3CT 60/5	80...480	230 Vac	-
K1NEMOD4B100	5 / 3CT 100/5	80...480	230 Vac	-
K1NEMOD4B150	5 / 3CT 150/5	80...480	230 Vac	-
K1NEMOD4B200	5 / 3CT 200/5	80...480	230 Vac	-
K1NEMOD4B250	5 / 3CT 250/5	80...480	230 Vac	-

Technical features

TECHNICAL NOTES	NT860
INPUT	
Three-phase voltage (V)	80...480 (phase-phase)
Current rating	5A
Continuous overload	1,2In
Istantaneous overload	20Imax/0,5s
Reference frequency	50Hz
Frequency tolerance	47...63Hz
Type of measurement	true RMS
Harmonic content	up to the 16th harmonic
Voltage rated burden (VA)	≤1 (each phase)
Current rated burden (VA)	≤0,5 (each phase)
AUXILIARY SUPPLY	
Rated value Uaux	230
Tolerance	0,85...1,1 Uaux
Reference frequency	50Hz
Frequency tolerance	47...63Hz
Rated burden	≤ 5VA – 2,5W
DISPLAY	
Type of display	LCD backlighted
Digit height	6mm
MECHANICAL FEATURES	
Housing	4 modules DIN 43880 (35mm)
Housing material	self-extinguishing polycarbonate
Protection degree	IP20 terminals/ IP54 front frame
Connections type	screw terminals
Rigid cable	output - max 4mm ² input - max 4mm ²
Flexible cable	output - max 2,5mm ² input - max 2,5mm ²
ENVIRONMENTAL CONDITIONS	
Nominal temperature range	-5...55°C
Limit range for storage and transport	-25...70°C
Suitable for tropical climates	yes
Max.power dissipation*	≤6,8W

* for switchboard thermal calculation

Wiring diagrams

Three-phase network 3-wire (ARON L1-L3)

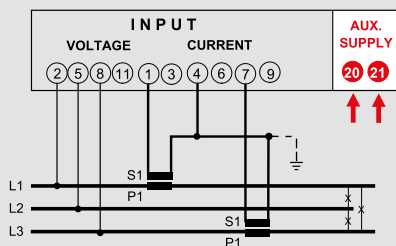

Three-phase network 3-wire (ARON L1-L2)

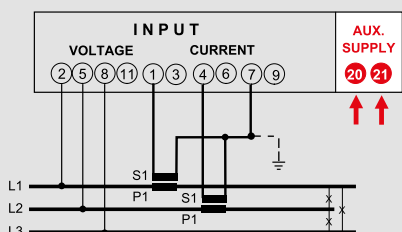

Wiring diagrams

Three-phase network 4-wire

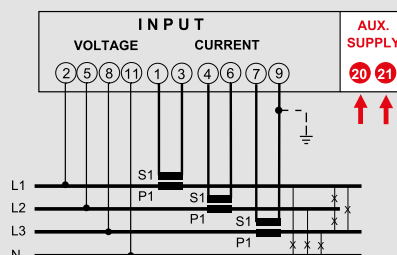

Multifunction meters

Multifunction for low voltage



Connection via CT for single and three-phase network, 3 or 4-wires. Phase sequence correction, diagnostic. It makes available active or reactive energy counting of the pulse output to integration of consumption supervision systems. For supervision systems, through the model with output RS485 communication ModbusRTU, you can transmit on the network main electrical parameters in addition to the energy consumption.

Functions

- Phase and linked voltage
- Min. and max. phase voltage
- THDV
- Neutral and phase current
- Current demand and current max. demand
- Average current
- THDI
- Active, reactive phase power
- Power demand and power max. demand
- Positive and negative active and reactive energy
- Power factor
- Frequency
- Run hour meter, count start with voltage or power present

Cat. Nos.	Nemo D4-e			Output
MFD4E06	Input (A) 5	Input* (V) 80...500	Auxiliary supply 230Vac	Pulse + RS485 ModBus RTU

* Three-phase input 80...500V, Single-phase input 50...290V

Technical features

TECHNICAL NOTES	NT901
INPUT	
Three-phase voltage (V)	80...500 (phase-phase)
Single-phase voltage (V)	50...290V
Current rating	5A
External CT ratio	max 50kA/5A
Continuous overload	1,2In
Istantaneous overload	20Imax/0,5s
Reference frequency	50Hz – 60Hz (automatic selection)
Frequency tolerance	45...65Hz (fn 50Hz) – 360...440Hz (fn 400Hz)
Type of measurement	true RMS
Harmonic content	up to the 25th harmonics
Voltage rated burden (VA)	≤ 0,2VA (phase-neutral)
Current rated burden (VA)	≤ 1VA (for phase)
AUXILIARY SUPPLY	
Rated value Uaux	230Vac
Reference frequency	50Hz
Frequency tolerance	45...65Hz
Rated burden	≤ 2,5VA (230Vac backlight 30%)
ACCURACY	
CONFORMITY ACCURACY WITH EN/IEC 61557-12	- Voltage: cl.0,5 - Current: cl. 1 - Active energy: cl.1 - Reactive energy cl.1 - Active power cl.1 - Reactive power cl.1 - Apparent power cl.1 - Frequency ± 0,1 Hz - THD cl.2
DISPLAY	
Type of display	LCD backlighted
Digit height	5/7mm
Energy resolution	depending on the CT ratio **
MECHANICAL FEATURES	
Housing	4 modules DIN 43880 (35mm)
Housing material	self-extinguishing polycarbonate
Protection degree	IP20 terminals/ IP54 front frame
Connections type	screw terminals
Rigid cable	output - max 4mm ² input - max 6mm ²
Flexible cable	output - max 2,5mm ² input - max 4mm ²
ENVIRONMENTAL CONDITIONS	
Nominal temperature range	-5...55°C
Limit range for storage and transport	-25...70°C
Suitable for tropical climates	yes
Max.power dissipation*	≤5W
* for switchboard thermal calculation	
** kCT	MAXIMUM DISPLAY
1...9	999999,99kWh/kvarh
10...99	9999999,9kWh/kvarh
100...999	99999999kWh/kvarh
1000...9999	999999,99MWh/Mvarh
Output	
ENERGY PULSES S0 EN/IEC 62053-31	
Type	Optorelay with potential-free
Contact range	27Vdc – 50mA
Assignable energy	Active or reactive energy
Pulse weight	selectable 10Wh/Varh...10MWh/MVarh
Pulse duration	selectable 50...300ms
RS485 COMMUNICATION	
Protocol	MODBUS RTU
Standard	RS485-3-wire
Baud rate	selectable 4800...19200 bit/s

Multifunction meters

Multifunction for low voltage

Wiring diagrams

Single phase network

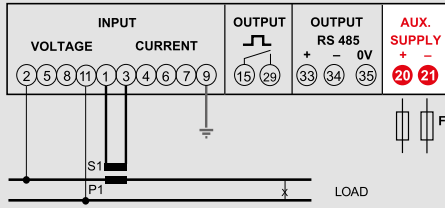

3-phase network, 3 wire

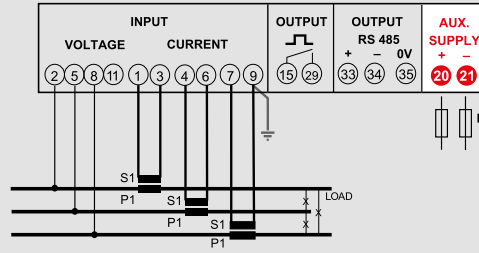

3-phase network, 3 wire (ARON L1-L3)

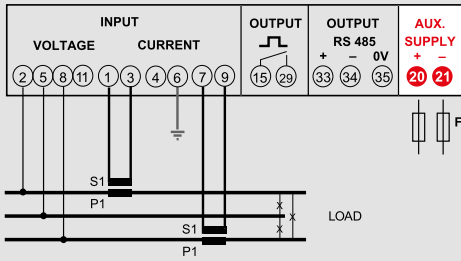

3-phase network, 4 wire

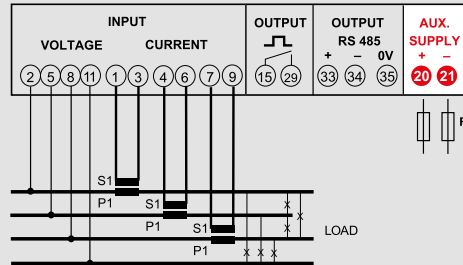

Multifunction meters

Multifunction for low voltage



Connection via CT for single and three-phase network, 3 or 4-wires. Phase sequence correction, diagnostic
It makes available active or reactive energy counting of the pulse output to integration of consumption supervision systems.
For supervision systems, through the model with output RS485 communication ModbusRTU, you can transmitted on the network main electrical parameters in addition to the energy consumption.

Functions

- Phase and linked voltage
- Min. and max. phase voltage
- THDV
- Voltage Harmonic analysis
- Voltage crest factor
- Phase angle between voltage
- Neutral and phase current
- Current demand and current max. demand
- Average current
- THDI
- Current Harmonic analysis
- Current crest factor
- Phase angle between current
- Active, reactive phase power
- Power demand and power max. demand
- Positive and negative active and reactive energy
- Power factor
- Phase angle between current and voltage
- Frequency
- Run hour meter, count start with voltage or power present

Cat. Nos.	Nemo D4-Le			Output
	Input (A)	Input* (V)	Auxiliary supply	
MFD4411	1 + 5	80...500	80...265Vac 100...300Vdc	Pulse or alarm
MFD4421	1 + 5	80...500	80...265Vac 100...300Vdc	Pulse or alarm + RS485 ModBus RTU/TCP
MFD44B1	1 + 5	80...500	80...265Vac 100...300Vdc	Pulse or alarm + RS485 BACnet
MFD4412	1 + 5	80...500	20...60 Vdc	Pulse or alarm
MFD4422	1 + 5	80...500	20...60 Vdc	Pulse or alarm + RS485 ModBus RTU/TCP
MFD44B2	1 + 5	80...500	20...60 Vdc	Pulse or alarm+ RS485 BACnet

* Three-phase input 80...500V, Single -phase input 50...290V

Technical features

TECHNICAL NOTES	NT864
INPUT	
Three-phase voltage (V)	80...500 (phase-phase)
Single-phase voltage (V)	50...290V
Current rating	1A - 5A
External CT ratio	max 50kA/5A - max 10kA/1A
External VT ratio	primary voltage max 1200V
Continuous overload	1,2In
Istantaneous overload	20Imax/0,5s
Reference frequency	50Hz - 400Hz (automatic selection)
Frequency tolerance	45...65Hz (fn 50Hz) - 360...440Hz (fn 400Hz)
Type of measurement	true RMS
Harmonic content	up to the 50th harmonics (45...65Hz)
Voltage rated burden (VA)	≤ 0,2VA (phase-neutral)
Current rated burden (VA)	≤ 1VA (for phase)
AUXILIARY SUPPLY	
Rated value Uaux	80...265Vac - 48Vac
Reference frequency	50 or 400Hz (automatic selection)
Frequency tolerance	45...65Hz (fn 50Hz) or 360...440Hz (fn 400Hz)
Rated burden	≤ 2,5VA (230Vac backlight 30%)
Rated value Uaux	100...300Vdc - 20...60Vdc
Rated burden	≤ 2,5W (24Vdc backlight 30%)
ACCURACY	
CONFORMITY ACCURACY WITH EN/IEC 61557-12	<ul style="list-style-type: none"> - Voltage: cl.0,5 - Current: cl. 0,5 - Active energy: cl.0,5 - Reactive energy cl.0,5 - Active power cl.05 - Reactive power cl.1 - Apparent power cl.1 - Frequency ± 0,1 Hz - THD (up to 50th harmonic) Harmonics single cl.1
DISPLAY	
Type of display	LCD backlighted
Digit height	5/7mm
Energy resolution	depending on the CT/VT ratio**
MECHANICAL FEATURES	
Housing	4 modules DIN 43880 (35mm)
Housing material	self-extinguishing polycarbonate
Protection degree	IP20 terminals/ IP54 front frame
Connections type	screw terminals
Rigid cable	output - max 4mm ² input - max 6mm ²
Flexible cable	output - max 2,5mm ² input - max 4mm ²
ENVIRONMENTAL CONDITIONS	
Nominal temperature range	-5...55°C
Limit range for storage and transport	-25...70°C
Suitable for tropical climates	yes
Max.power dissipation*	≤5W

* for switchboard thermal calculation

** kCT*kVT	MAXIMUM DISPLAY
1...9	999999,99kWh/kvarh
10...99	9999999,9kWh/kvarh
100...999	99999999kWh/kvarh
1000...9999	999999,99MWh/Mvarh
10000...99999	9999999,9MWh/Mvarh

Multifunction meters

Multifunction for low voltage

Output

ENERGY PULSES S0 EN/IEC 62053-31	
Type	Optorelay with potential-free
Contact range	27 Vcc/ca-50mA
Assignable energy	Active or reactive energy
Pulse weight	selectable 10Wh/Varh...10Wh/Varh
Pulse duration	selectable from 50 to 500ms
ALARM	
Type	Optorelay with potential-free
Contact range	27 Vcc/ca-50mA
Type alarm	min. or max

RS485 COMMUNICATION	
Protocol	MODBUS RTU/TCP
Standard	RS485-3-wire
Baud rate	selectable 4800...38400 bit/s
BACNET RS485 COMMUNICATION	
Protocol	BACNET MS-TP
Standard	RS485-3-wire
Baud rate	selectable 4800...76800 bit/s

Wiring diagrams

Single phase network

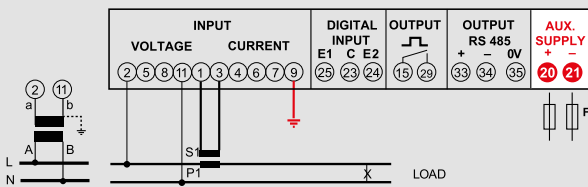

3-phase network, 3 wire

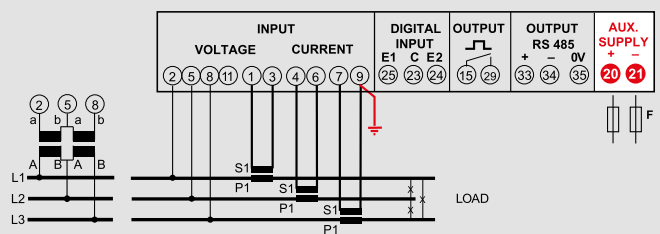

3-phase network, 3 wire, 1 System

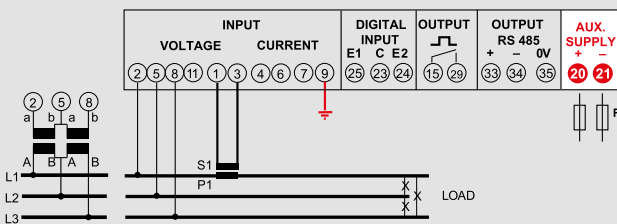

3-phase network, 4 wire

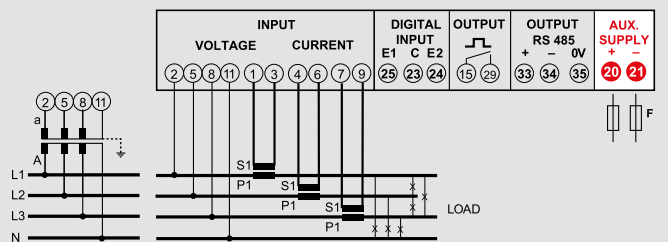

3-phase network, 4 wire, 1 System

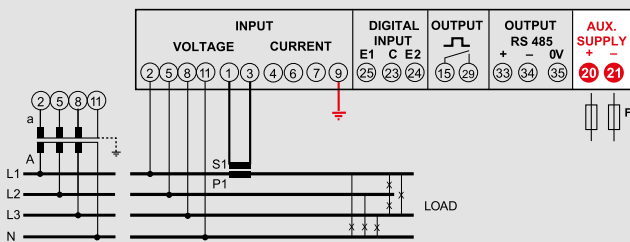

3-phase network, 3 wire

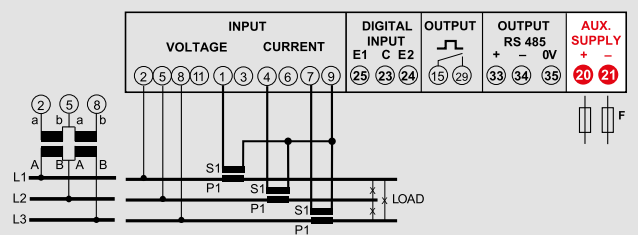

3-phase network, 3 wire (ARON L1-L3)

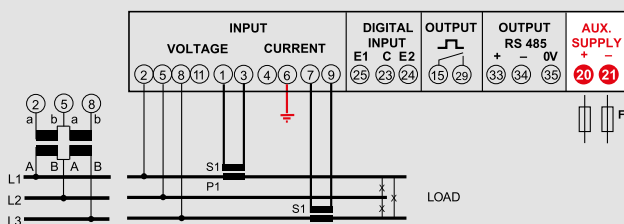

3-phase network, 4 wire

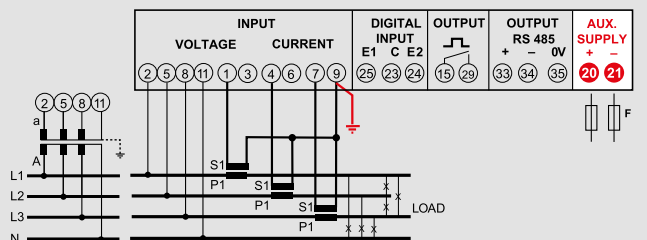

Multifunction meters

KIT Multifunction and rogowski coils for low voltage



Connection via dedicated rogowski coils for single and three-phase network, 3 or 4-wires.

Phase sequence correction, diagnostic

It makes available active or reactive energy counting of the pulse output to integration of consumption supervision systems.

For supervision systems, through the model with output RS485 communication ModbusRTU, you can transmitted on the network main electrical parameters in addition to the energy consumption.

Functions

- Neutral and phase current
- Phase and linked voltage
- Min. and max. phase voltage
- THDV
- Voltage Harmonic analysis
- Voltage crest factor
- Phase angle between voltage
- Neutral and phase current
- Current demand and current max. demand
- Average current
- THDI
- Current Harmonic analysis
- Current crest factor
- Phase angle between current
- Active, reactive phase power
- Power demand and power max. demand
- Positive and negative active and reactive energy
- Power factor
- Phase angle between current and voltage
- Frequency
- Run hour meter, count start with voltage or power present

Cat. Nos. **KIT Nemo D4-Le + 3 Rogowski coils**

Cat. Nos.	Input (A) /RC**	Input* (V)	Auxiliary supply	Output
KRNEMOD4LE080	3RC 80mm ²	80...500	80...265Vac 100...300Vdc	Pulse or alarm + RS485 ModBus RTU/TCP
KRNEMOD4LE142	3RC 142mm ²	80...500	80...265Vac 100...300Vdc	Pulse or alarm + RS485 ModBus RTU/TCP
KRNEMOD4LE190	3RC 190mm ²	80...500	80...265Vac 100...300Vdc	Pulse or alarm + RS485 ModBus RTU/TCP

* Three-phase input 80...500V, Single -phase input 50...290V

** 3 current ranges that can be selected on each KIT: 20...1000A, 60...3000A, 100...5000A

Technical features

TECHNICAL NOTES	NT889
INPUT	
Three-phase voltage (V)	80...500 (phase-phase)
Single-phase voltage (V)	50...290V
Current rating	20...1000A, 60...3000A, 100...5000A
External VT ratio	primary voltage max 1200V
Reference frequency	50Hz
Frequency tolerance	45...65Hz (fn 50Hz)
Type of measurement	true RMS
Harmonic content	up to the 40th harmonics (45...65Hz)
Voltage rated burden (VA)	≤ 0,2VA (phase-neutral)
AUXILIARY SUPPLY	
Rated value Uaux	80...265Vac - 48Vac
Reference frequency	50 or 400Hz (automatic selection)
Frequency tolerance	45...65Hz (fn 50Hz) or 360...440Hz (fn 400Hz)
Rated burden	≤ 2,5VA (230Vac backlight 30%)
Rated value Uaux	100...300Vdc - 20...60Vdc
Rated burden	≤ 2,5W (24Vdc backlight 30%)
ACCURACY	
CONFORMITY ACCURACY WITH EN/IEC 61557-12	<ul style="list-style-type: none"> - Voltage: cl.0,5 - Current: cl. 1 - Active energy: cl.1 - Reactive energy cl.1 - Active power cl.1 - Reactive power cl.1 - Apparent power cl.1 - Frequency ± 0,1 Hz - THD (up to 50th harmonic) Harmonics single cl.1
DISPLAY	
Type of display	LCD backlighted
Digit height	5/7mm
Energy resolution	depending on the RC/VT ratio**
MECHANICAL FEATURES	
Housing	4 modules DIN 43880 (35mm)
Housing material	self-extinguishing polycarbonate
Protection degree	IP20 terminals/ IP54 front frame
Connections type	screw terminals
Rigid cable	output - max 4mm ² input - max 6mm ²
Flexible cable	output - max 2,5mm ² input - max 4mm ²
ENVIRONMENTAL CONDITIONS	
Nominal temperature range	-5...55°C
Limit range for storage and transport	-25...70°C
Suitable for tropical climates	yes
Max.power dissipation*	≤5W
** kRCx kVT MAXIMUM DISPLAY 200...999 99999999kWh/kvarh 1000...9999 999999,99MWh/Mvarh kRC = 200 for range 200...1000A = 600 for range 600...3000A = 1000 for range 100...5000A	
Output	
ENERGY PULSES S0 EN/IEC 62053-31	
Type	Optorelay with potential-free
Contact range	27 Vcc/ca-50mA
Assignable energy	Active or reactive energy
Pulse weight	selectable 10Wh/Varh...10MWh/MVarh
Pulse duration	selectable from 50 to 500ms
ALARM	
Type	Optorelay with potential-free
Contact range	27 Vcc/ca-50mA
Type alarm	min. or max
RS485 COMMUNICATION	
Protocol	MODBUS RTU/TCP
Standard	RS485-3-wire
Baud rate	selectable 4800...38400 bit/s

Multifunction meters

KIT Multifunction and rogowski coils for low voltage

Wiring diagrams

Single phase network

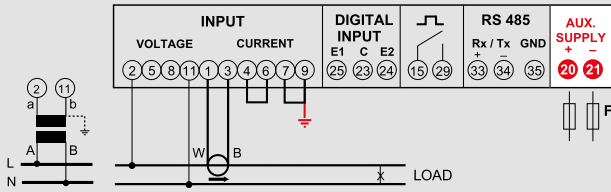

3-phase network, 3 wire (ARON L1-L3)

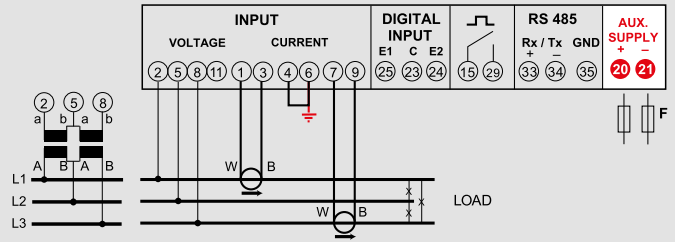

3-phase network, 3 wire, 1 System

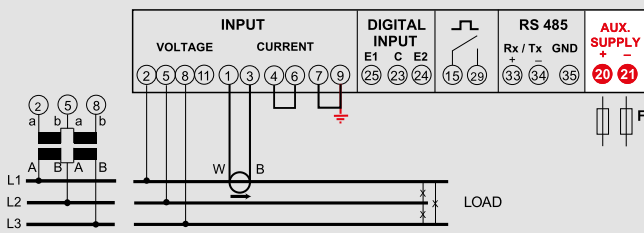

3-phase network, 3 wire

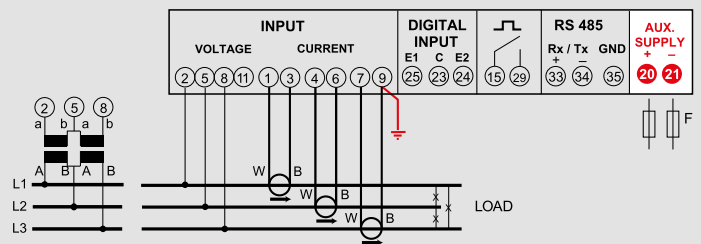

3-phase network, 4 wire, 1 System

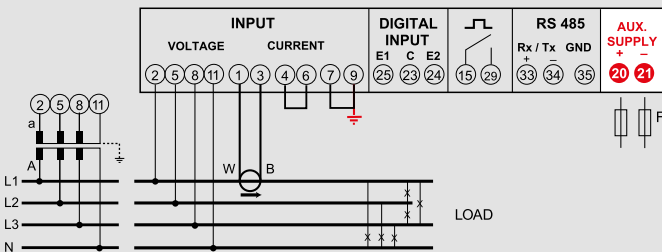

3-phase network, 4 wire

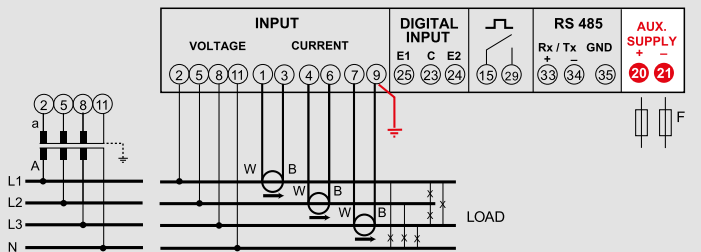

Multifunction meters

Multifunction for low and medium voltage



Connection via CT for single and three-phase network, 3 or 4-wires. Phase sequence correction, diagnostic. It makes available active or reactive energy counting of the pulse output to integration of consumption supervision systems. For supervision systems, through the model with output RS485 communication ModbusRTU, you can transmit on the network main electrical parameters in addition to the energy consumption.

Functions

- Phase and linked voltage
- THDV
- Neutral and phase current
- Current demand and current max. demand
- Active, reactive phase power
- Power demand and power max. demand
- Positive and negative active and reactive energy
- Power factor
- Phase angle between current and voltage
- Frequency
- Run hour meter, count start with voltage present

Cat. Nos.	Nemo D4-L+			
	Input (A)	Input* (V)	Auxiliary supply	Output
MF6HT40003	1 + 5	80...480	115 Vac	Pulse + RS485 ModBus RTU/TCP
MF6HT40003	1 + 5	80...480	230-240 Vac	Pulse + RS485 ModBus RTU/TCP
MF6HT4000H	1 + 5	80...480	20..150 Vdc + 48 Vac	Pulse + RS485 ModBus RTU/TCP
MF6HTU0003	1 + 5	80...480	115 Vac	Pulse
MF6GTU0006	1 + 5	80...480	230-240 Vac	Pulse
MF6GTU000H	1 + 5	80...480	20..150 Vdc + 48 Vac	Pulse

* Three-phase input 80...480V, Single -phase input 45...278V

Technical features

TECHNICAL NOTES	NT695
INPUT	
Three-phase voltage (V)	80...480 (phase-phase)
Single-phase voltage (V)	45...278V
Current rating	1A - 5A
External CT ratio	max 50kA/5A - max 10kA/1A
External VT ratio	primary voltage max 40kV
Continuous overload	1,2In
Istantaneous overload	20Imax/0,5s
Reference frequency	50Hz
Frequency tolerance	47...63Hz
Type of measurement	true RMS
Harmonic content	according to EN/IEC 61557-12 (up to 31a harmonic)
Voltage rated burden (VA)	≤1 (each phase)
Current rated burden (VA)	≤0,5 (each phase)

AUXILIARY SUPPLY	
Rated value Uaux	48 – 115 - 230 (single phase)
Tolerance	0,85...1,15Uaux - 40...60V (Uaux 48V)
Reference frequency	50Hz
Frequency tolerance	47...63Hz
Rated burden	≤ 5VA – 2,5W

ACCURACY	
CONFORMITY ACCURACY WITH EN/IEC 61557-12	- voltage: cl.0,5 - Current: cl. 0,5 - Active energy: cl.1 - Reactive energy cl.2 - Active power cl.0,5 - Reactive power cl.0,5 - Apparent power cl.0,5 - Frequency ± 0,1 Hz - THD (up to 31th harmonic) Harmonics single cl.1

DISPLAY	
Type of display	LCD backlighted
Digit height	6mm
Energy resolution	depending on the CT/VT ratio**

MECHANICAL FEATURES	
Housing	4 modules DIN 43880 (35mm)
Housing material	self-extinguishing polycarbonate
Protection degree	IP20 terminals/ IP54 front frame
Connections type	screw terminals
Rigid cable	output - max 4mm ² input - max 6mm ²
Flexible cable	output - max 4,5mm ² input - max 4mm ²

ENVIRONMENTAL CONDITIONS	
Nominal temperature range	-5...55°C
Limit range for storage and transport	-25...70°C
Suitable for tropical climates	yes
Max.power dissipation*	≤6,8W

* for switchboard thermal calculation

** kCT*kVT	MAXIMUM DISPLAY
1...9	999999,99kWh/kvarh
10...99	9999999,9kWh/kvarh
100...999	99999999kWh/kvarh
1000...9999	999999,99MWh/Mvarh
10000...99999	9999999,9MWh/Mvarh
100000...400000	99999999MWh/Mvarh

Output

ENERGY PULSES S0 EN/IEC 62053-31	
Type	Optorelay with potential-free
Contact range	27 Vcc/ca-50mA
Assignable energy	Active or reactive energy
Pulse weight	selectable 0,1Wh/Varh...100MWh/MVarh
Pulse duration	selectable from 50 to 300ms

RS485 COMMUNICATION	
Protocol	MODBUS RTU/TCP
Standard	RS485-3-wire
Baud rate	selectable 4800...19200 bit/s

Multifunction meters

Multifunction for low and medium voltage

Wiring diagrams

Single phase network

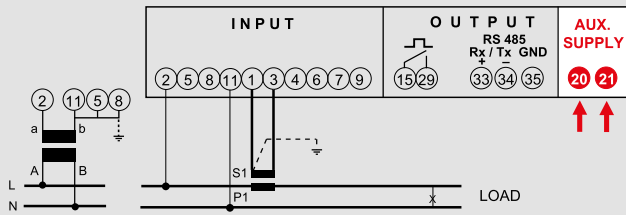

3-phase network, 3 wire (ARON L1-L2)

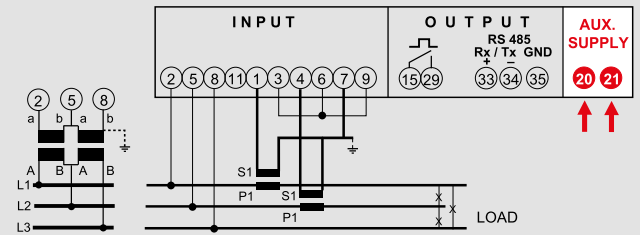

3-phase network, 3 wire (ARON L1-L3)

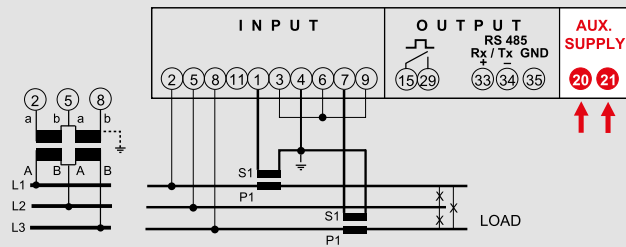

3-phase network, 3 wire (ARON L2-L3)

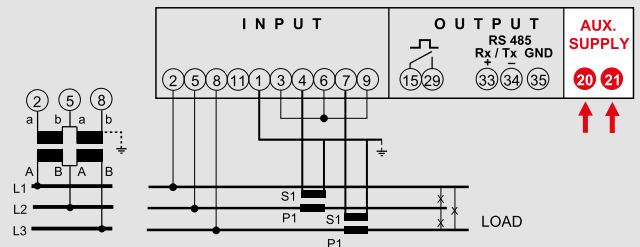

3-phase network, 3 wire

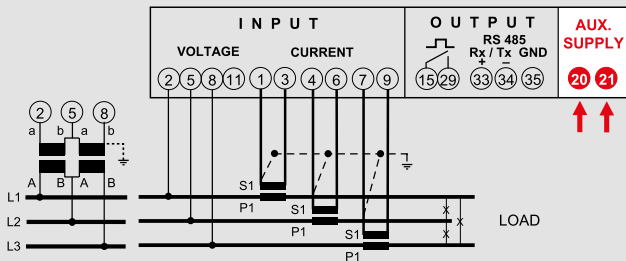

3-phase network, 4 wire

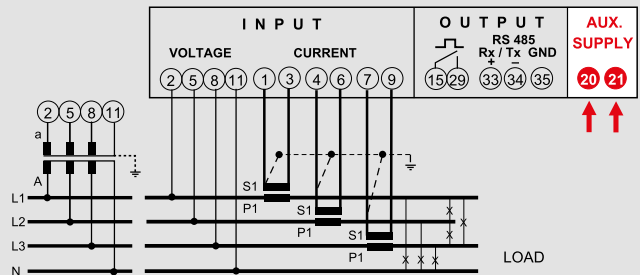

3-phase network, 3 wire, 1 System

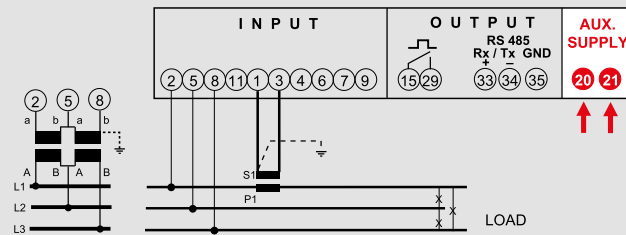

3-phase network, 4 wire, 1 System

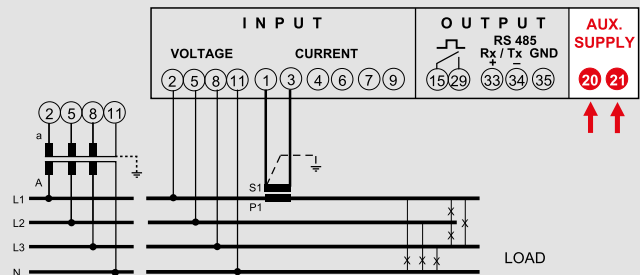

Multifunction meters

Multifunction for direct current



Direct voltage input by external adapter up to 1500V

Direct current input or from shunt (selectable)

- Direct input up to 10A direct current

- Input from shunt 60 – 100 – 150mV

It makes available active or reactive energy counting of the pulse output to integration of consumption supervision systems.

For supervision systems, through the model with output RS485 communication ModbusRTU, you can transmitted on the network main electrical parameters in addition to the energy consumption.

Functions

- Voltage
- Current
- Power
- Power demand and power max. demand
- Positive energy
- Negative energy
- Positivi and negative Ah
- Run hour meter, count start with voltage present

Cat. Nos.	Nemo D4-Dc			
	Input (A)	Input* (V)	Auxiliary supply	Output
MF6DC4200H	note 1	10...300V	20..150 Vdc + 48 Vac	Pulse + 2 alarms + RS485 ModBus RTU
MF6DC42006	note 1	10...300V	230-240 Vac	Pulse + 2 alarms + RS485 ModBus RTU
MF6DC4206H	note 1	50...1500V*	20..150 Vdc + 48 Vac	2 alarms + RS485 ModBus RTU
MF6DC42066	note 1	50...1500V*	230-240 Vac	2 alarms + RS485 ModBus RTU

* with AVMD150 adapter 2 moduloes

note 1 Direct input up to 10A direct current, Input from shunt 60 – 100 – 150mV

Technical features

TECHNICAL NOTES		NT753
INPUT		
MF6DC4200H	Direct input	10...300Vdc
MF6DC42006	Input impedance	> 300kΩ
MF6DC4206H	Input by adapter	50...1500Vdc
MF6DC42066	Input impedance	> 3 MΩ
Instantaneous overload		10In/0,5s
Direct Input		0...10A
Voltage drop:		≤ 100mV (In10A)
Input from shunt		60 – 100 – 150mV
Shunt primary		1...9999A
AUXILIARY SUPPLY		
Rated value Uaux ac		48 – 230V
Tolerance		0,85...1,15Uaux - 40...60V (Uaux 48V)
Reference frequency		50Hz
Frequency tolerance		47...63Hz
Rated burden		≤ 5VA – 3W
Rated value Uaux dc		20...150Vdc
Rated burden		≤ 2W
ACCURACY		
CONFORMITY ACCURACY WITH EN/IEC 61557-12		- voltage: ± 0,5% (10...100% Un) - Current: ± 0,5% (10...100% In) - Power: ± 1% (10...100% Pn)
DISPLAY		
Type of display		LCD backlighted
Digit height		6mm
MECHANICAL FEATURES		
Housing		4 modules DIN 43880 (35mm) (6 modules with AVMD150 adapter)
Housing material		self-extinguishing polycarbonate
Protection degree		IP20 terminals/ IP52 front frame
Connections type		screw terminals
Rigid cable		output - max 4mm ² input - max 6mm ²
Flexible cable		output - max 4,5mm ² input - max 4mm ²
ENVIRONMENTAL CONDITIONS		
Nominal temperature range		-5...55°C
Limit range for storage and transport		-25...70°C
Suitable for tropical climates		yes
Max.power dissipation*		≤ 4W (Uax ca) - ≤ 4W (Uax cc)
* for switchboard thermal calculation		
Output		
ENERGY PULSES S0 EN/IEC 62053-31		
Type	Optorelay with potential-free	
Contact range	27 Vcc/ca-50mA	
Assignable energy	Active or reactive energy	
Pulse weight	selectable 0,1kWh - 1kWh - 10kWh - 100kWh	
Pulse duration	selectable from 50 to 300ms	
RS485 COMMUNICATION		
Protocol	MODBUS RTU	
Standard	RS485-3-wire	
Baud rate	selectable 4800...19200 bit/s	
OUTPUT RELAY		
Type	2 relays with potential-free	
Output function	2 singularly-programmable independent alarms	
Contact range	5A 250Vac cosφ 1 - 3A 250Vac cosφ 0,4 - 5A 30Vdc	

Multifunction meters

Multifunction for direct current

Wiring diagrams

MF6DC4206H - MF6DC42066
 INPUT 50...1500Vdc line connected with earth

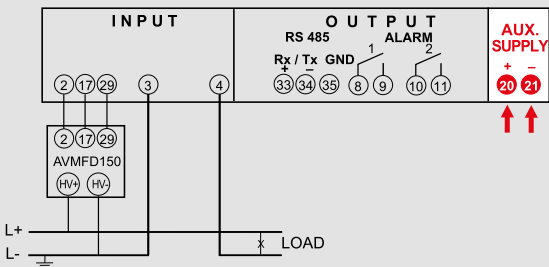
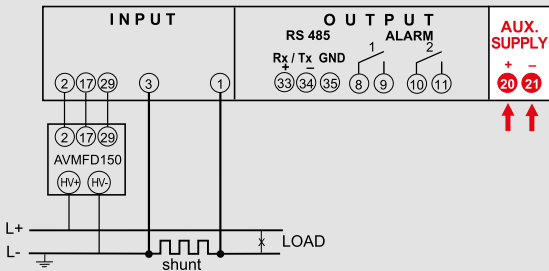
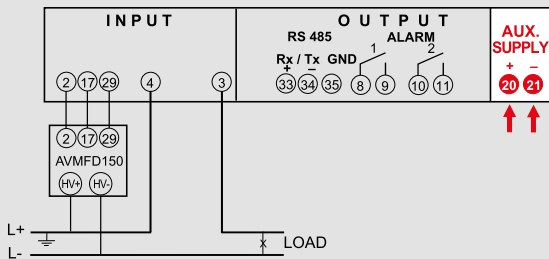
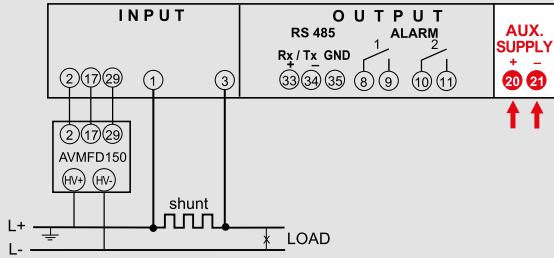

MF6DC4206H - MF6DC42066
 INPUT 50...1500Vdc line insulated from earth

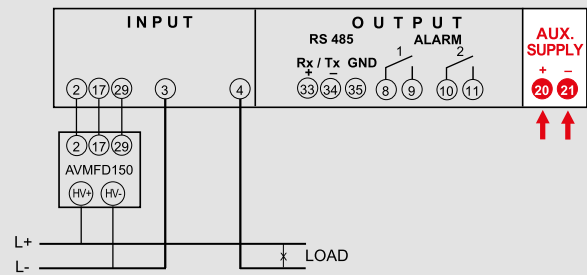
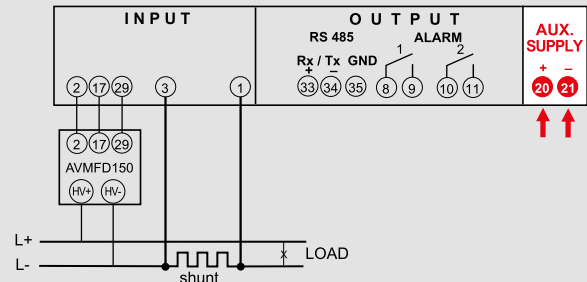
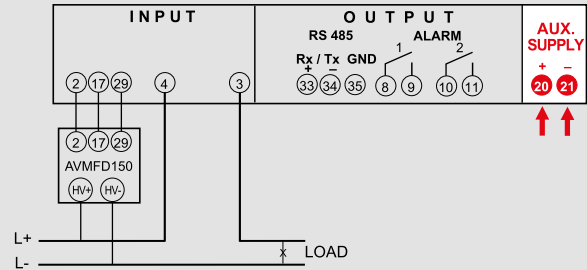
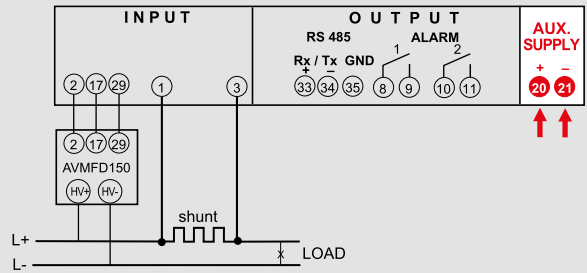

MF6DC4200H - MF6DC42006
 INPUT 10...300Vdc /dc

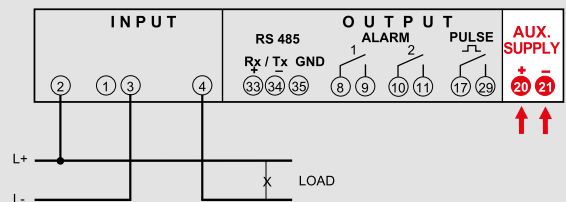
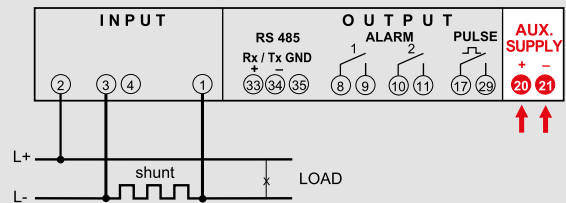

Multifunction meters

Flush mounting multifunction for low voltage



Connection via CT for single and three-phase network, 3 or 4-wires. Phase sequence correction, diagnostic

Functions

- Phase and linked voltage
- Neutral and phase current
- Current demand and current max. demand
- Power demand and power max. demand
- Power factor
- Frequency
- Run hour meter, count start with voltage present
- State of alarms

Cat. Nos.	Nemo 72-b			
	Input Network (A)	Input (V)	Auxiliary supply	Output
MF7GM0009A	1Ph - 3Ph+N	195(340) - 260(450)Vac	Self supplied	-
MF7GM2009A	1Ph - 3Ph+N	195(340) - 260(450)Vac	Self supplied	2 alarms
MF7GM0008A	1Ph - 3Ph+N	195(340) - 260(450)Vac	Self supplied	-
MF7GM2008A	1Ph - 3Ph+N	195(340) - 260(450)Vac	Self supplied	2 alarms
MF7GT0009A	3Ph - 3Ph+N	340...450Vac	Self supplied	-
MF7GT2009A	3Ph - 3Ph+N	340...450Vac	Self supplied	2 alarms
MF7GT0008A	3Ph - 3Ph+N	340...450Vac	Self supplied	-
MF7GT2008A	3Ph - 3Ph+N	340...450Vac	Self supplied	2 alarms

Technical features

TECHNICAL NOTES	NT651
INPUT	
Three-phase voltage (V)	340...450V (phase-phase)
Single-phase voltage (V)	195...260V
Current rating	1A - 5A
External CT ratio	5/10/15/20/25/30/40/50/60/70/75/80/100/120/125/150/160/200/250/300/400/500/600/700/750/800/1000/1200/1250/1500/1600/2000/2500/3000/3200/4000/5000/6000/7000/7500/8000A
Continuous overload	1,2In
Istantaneous overload	20Imax/0,5s
Reference frequency	50Hz
Frequency tolerance	47...63Hz
Type of measurement	true RMS
Harmonic content	up to the 21th harmonic
Voltage rated burden (VA)	≤0,5 (each phase)
Current rated burden (VA)	≤0,5 (each phase)
AUXILIARY SUPPLY	
Self-supplied	L(1) - N (mod. MF7GM..) L1 - L2 (mod. MF7GT..)
Rated burden	≤ 2VA - ≤ 2,5VA (with alarms)
ACCURACY	
CONFORMITY ACCURACY WITH EN/IEC 61557-12	- voltage: ± 0,5% (340...450V phase - phase) - Current: ± 0,5% (10...120% In) - Neutral current: ± 2% - Power: ± 1% P - ± 2% Q / S (10...120% Pn/Qn/Sn cosφ 0,5 ind...0,5cap) - Power factor: ± 2% - Frequency: ± 0,2 Hz
DISPLAY	
Type of display	LCD backlighted
Digit height	6mm
MECHANICAL FEATURES	
Housing	flush mounting (panel cutout 68x68mm)
Front frame	72x72mm
Housing material	self-extinguishing makrolon
Protection degree	IP20 terminals/ IP54 front frame
Connections type	screw terminals
Rigid cable	output - max 4mm ² input - max 4mm ²
Flexible cable	output - max 2,5mm ² input - max 2,5mm ²
ENVIRONMENTAL CONDITIONS	
Nominal temperature range	-5...55°C
Limit range for storage and transport	-25...70°C
Suitable for tropical climates	yes
Max.power dissipation*	≤6,8W

* for switchboard thermal calculation

Wiring diagrams

Three-phase network 4-wire

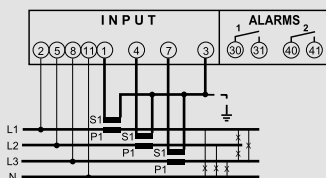

Single-phase network

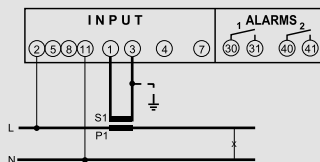

Three-phase network 3-wire (ARON L1-L3)

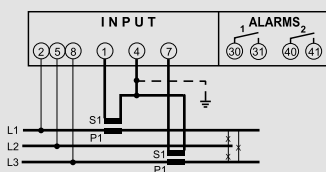

Three-phase network 3-wire (ARON L1-L2)

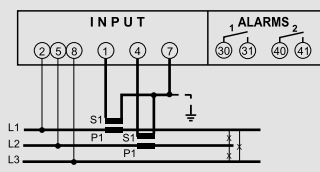

Dimensions

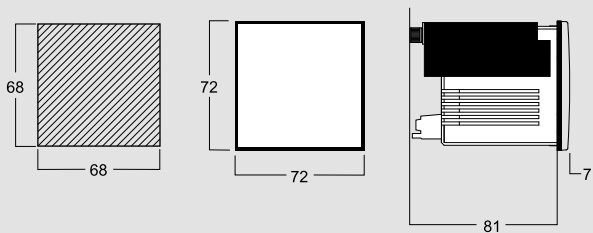

Multifunction meters

KIT Flush mounting multifunction and CT for low voltage



Connection via CT for three-phase network, 3 or 4-wires.
Phase sequence correction, diagnostic

Functions

- Phase and linked voltage
- Neutral and phase current
- Current demand and current max. demand
- Power demand and power max. demand
- Power factor
- Frequency
- Run hour meter, count start with voltage present
- State of alarms

Cat. Nos.	KIT Nemo 72-b + 3 CT (TAIBB MODEL)			
	Input (A) /CT (A)	Input Network (V)	Auxiliary supply	Output
K1NEMO72B040	5 / 3CT 40/5	3Ph - 3Ph+N	Self supplied	-
K1NEMO72B050	5 / 3CT 50/5	3Ph - 3Ph+N	Self supplied	-
K1NEMO72B060	5 / 3CT 60/5	3Ph - 3Ph+N	Self supplied	-
K1NEMO72B100	5 / 3CT 100/5	3Ph - 3Ph+N	Self supplied	-
K1NEMO72B150	5 / 3CT 150/5	3Ph - 3Ph+N	Self supplied	-
K1NEMO72B200	5 / 3CT 200/5	3Ph - 3Ph+N	Self supplied	-
K1NEMO72B250	5 / 3CT 250/5	3Ph - 3Ph+N	Self supplied	-

Technical features

TECHNICAL NOTES	NT870
INPUT	
Three-phase voltage (V)	340...450V (phase-phase)
Current rating	5A
Continuous overload	1,2In
Istantaneous overload	20Imax/0,5s
Reference frequency	50Hz
Frequency tolerance	47...63Hz
Type of measurement	true RMS
Harmonic content	up to the 21th harmonic
Voltage rated burden (VA)	≤0,5 (each phase)
Current rated burden (VA)	≤0,5 (each phase)
AUXILIARY SUPPLY	
Self-supplied	L1 - L2
Rated burden	≤ 2VA
ACCURACY	
CONFORMITY ACCURACY WITH EN/IEC 61557-12	- voltage: ± 0,5% (340...450V phase - phase) - Current: ± 0,5% (10...120% In) - Neutral current: ± 2% - Power: ± 1% P - ± 2% Q / S (10...120% Pn/ Qn/Sn cosj 0,5 ind...0,5cap) - Power factor: ± 2% - Frequency: ± 0,2 Hz
DISPLAY	
Type of display	LCD backlighted
Digit height	6mm
MECHANICAL FEATURES	
Housing	flush mounting (panel cutout 68x68mm)
Front frame	72x72mm
Housing material	self-extinguishing makrolon
Protection degree	IP20 terminals/ IP54 front frame
Connections type	screw terminals
Rigid cable	output - max 4mm ² input - max 4mm ²
Flexible cable	output - max 2,5mm ² input - max 2,5mm ²
ENVIRONMENTAL CONDITIONS	
Nominal temperature range	-5...55°C
Limit range for storage and transport	-25...70°C
Suitable for tropical climates	yes
Max.power dissipation*	≤6,8W

* for switchboard thermal calculation

Wiring diagrams

Three-phase network 3-wire (ARON L1-L3)

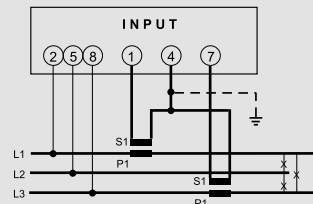

Three-phase network 3-wire (ARON L1-L2)

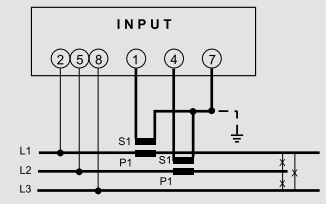

Three-phase network 4-wire

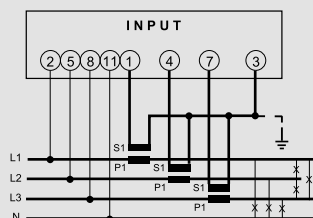

Dimensions

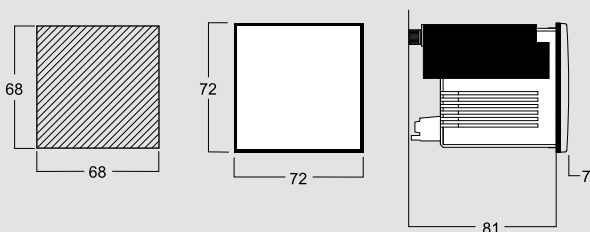

Multifunction meters

Flush mounting multifunction for low voltage



Connection via CT for single and three-phase network, 3 or 4-wires. Phase sequence correction, diagnostic. It makes available active or reactive energy counting of the pulse output to integration of consumption supervision systems. For supervision systems, through the model with output RS485 communication ModbusRTU, you can transmitted on the network main electrical parameters in addition to the energy consumption.

Functions

- Phase and linked voltage
- Min. and max. phase voltage
- THDV
- Voltage Harmonic analysis
- Voltage crest factor
- Phase angle between voltage
- Neutral and phase current
- Current demand and current max. demand
- Average current
- THDI
- Current Harmonic analysis
- Current crest factor
- Phase angle between current
- Active, reactive phase power
- Power demand and power max. demand
- Positive and negative active and reactive energy
- Power factor
- Phase angle between current and voltage
- Frequency
- Run hour meter, count start with voltage or power present

Cat. Nos.	Nemo 72-Le			
	Input (A)	Input* (V)	Auxiliary supply	Output
MF72411	1 + 5	80...500	80...265Vac 100...300Vdc	Pulse or alarm
MF72421	1 + 5	80...500	80...265Vac 100...300Vdc	Pulse or alarm + RS485 ModBus RTU/TCP
MF724B1	1 + 5	80...500	80...265Vac 100...300Vdc	Pulse or alarm + RS485 BACnet
MF72412	1 + 5	80...500	20...60 Vdc	Pulse or alarm
MF72422	1 + 5	80...500	20...60 Vdc	Pulse or alarm + RS485 ModBus RTU/TCP
MF724B2	1 + 5	80...500	20...60 Vdc	Pulse or alarm + RS 485 BACnet

* Three-phase input 80...500V, Single -phase input 50...290V

Technical features

TECHNICAL NOTES	NT879
INPUT	
Three-phase voltage (V)	80...500 (phase-phase)
Single-phase voltage (V)	50...290V
Current rating	1A - 5A
External CT ratio	max 50kA/5A - max 10kA/1A
External VT ratio	primary voltage max 1200V
Continuous overload	1,2In
Istantaneous overload	20Imax/0,5s
Reference frequency	50Hz - 400Hz (automatic selection)
Frequency tolerance	45...65Hz (fn 50Hz) - 360...440Hz (fn 400Hz)
Type of measurement	true RMS
Harmonic content	up to the 50th harmonics (45...65Hz)
Voltage rated burden (VA)	≤ 0,2VA (phase-neutral)
Current rated burden (VA)	≤ 1VA (for phase)
AUXILIARY SUPPLY	
Rated value Uaux	80...265Vac - 48Vac
Reference frequency	50 or 400Hz (automatic selection)
Frequency tolerance	45...65Hz (fn 50Hz) or 360...440Hz (fn 400Hz)
Rated burden	≤ 2,5VA (230Vac backlight 30%)
Rated value Uaux	100...300Vdc - 20...60Vdc
Rated burden	≤ 2,5W (24Vdc backlight 30%)
ACCURACY	
CONFORMITY ACCURACY WITH EN/IEC 61557-12	- voltage: cl.0,5 - Current: cl. 0,5 - Active energy: cl.0,5 - Reactive energy cl.1 - Active power cl.05 - Reactive power cl.1 - Apparent power cl.1 - Frequency ± 0,1 Hz - THD (up to 50th harmonic) Harmonics single cl.1
DISPLAY	
Type of display	LCD backlighted
Digit height	6mm
Energy resolution	depending on the CT/VT ratio**
MECHANICAL FEATURES	
Housing	flush mounting (panel cutout 68x68mm)
Front frame	72x72mm
Housing material	self-extinguishing makrolon
Protection degree	IP20 terminals/ IP54 front frame
Connections type	screw terminals
Rigid cable	output - max 4mm ² input - max 6mm ²
Flexible cable	output - max 2,5mm ² input - max 4mm ²
ENVIRONMENTAL CONDITIONS	
Nominal temperature range	-5...55°C
Limit range for storage and transport	-25...70°C
Suitable for tropical climates	yes
Max.power dissipation*	≤5W

* for switchboard thermal calculation

** kCT*kVT	MAXIMUM DISPLAY
1...9	999999,99kWh/kvarh
10...99	9999999,9kWh/kvarh
100...999	99999999kWh/kvarh
1000...9999	999999,99MWh/Mvarh
10000...99999	9999999,9MWh/Mvarh

Dimensions

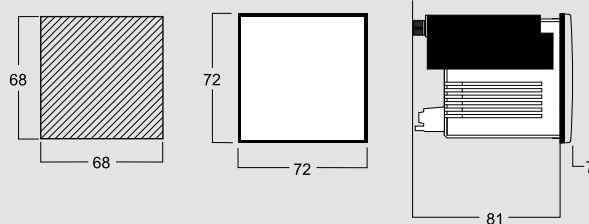

Multifunction meters

Flush mounting multifunction for low voltage

Output

ENERGY PULSES S0 EN/IEC 62053-31	
Type	Optorelay with potential-free
Contact range	27 Vcc/ca-50mA
Assignable energy	Active or reactive energy
Pulse weight	selectable 10Wh/Varh...10MWh/MVarh
Pulse duration	selectable from 50 to 500ms
ALARM	
Type	Optorelay with potential-free
Contact range	27 Vcc/ca-50mA
Type alarm	min. or max
RS485 COMMUNICATION	
Protocol	MODBUS RTU/TCP
Standard	RS485-3-wire
Baud rate	selectable 4800...38400 bit/s
BACNET RS485 COMMUNICATION	
Protocol	BACNET MS-TP
Standard	RS485-3-wire
Baud rate	selectable 4800...76800 bit/s

Wiring diagrams

Single phase network

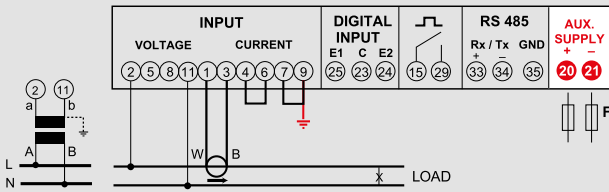

3-phase network, 3 wire (ARON L1-L3)

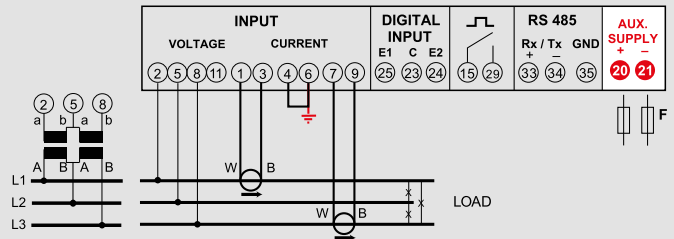

3-phase network, 3 wire, 1 System

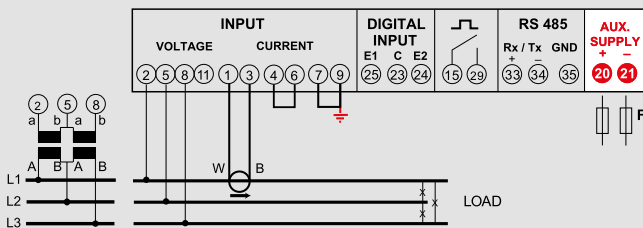

3-phase network, 3 wire

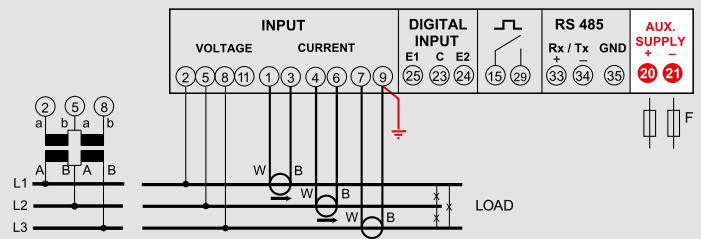

3-phase network, 4 wire, 1 System

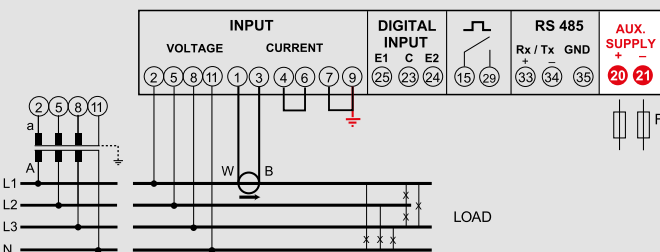

3-phase network, 4 wire

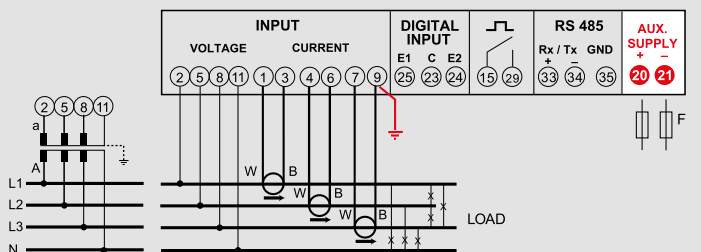

Multifunction meters

Flush mounting multifunction for low voltage



Connection via CT for single and three-phase network, 4-wires. Phase sequence correction, diagnostic. It makes available active or reactive energy counting of the pulse output to integration of consumption supervision systems. For supervision systems, through the model with output RS485 communication ModbusRTU, you can transmitted on the network main electrical parameters in addition to the energy consumption.

Functions

- Phase and linked voltage
- Min. and max. phase voltage
- THDV
- Neutral and phase current
- Current demand and current max. demand
- Average current
- THDI
- Active, reactive phase power
- Power demand and power max. demand
- Positive and negative active and reactive energy
- Power factor
- Frequency
- Run hour meter, count start with voltage or power present

Cat. Nos.	Nemo 96 HDe			Output
MF96E06	Input (A) 5	Input* (V) 500	Auxiliary supply self-supplied	Pulse + RS485

* Three-phase input 500V, Single -phase input 230-240V

Technical features

TECHNICAL NOTES	NT900
INPUT	
Three-phase voltage (V)	500 (phase-phase)
Single-phase voltage (V)	230-240V
Current rating	5A
External CT ratio	max 50kA/5A
Continuous overload	1,2In
Istantaneous overload	20Imax/0,5s
Reference frequency	50Hz – 400Hz (automatic selection)
Frequency tolerance	45...65Hz (fn 50Hz) – 360...440Hz (fn 400Hz)
Type of measurement	true RMS
Harmonic content	up to the 50th harmonics
Voltage rated burden (VA)	≤ 0,1VA (phase-neutra)
Current rated burden (VA)	≤ 1VA (for phase)

AUXILIARY SUPPLY	
Nominal voltage	Taken from measurement (self-supplied)

ACCURACY	
CONFORMITY ACCURACY WITH EN/IEC 61557-12	- voltage: cl.0,5 - Current: cl. 0,5 - Active energy: cl.1 - Reactive energy cl.1 - Active power cl.1 - Reactive power cl.1 - Apparent power cl.1 - Frequency ± 0,1Hz - THD cl.1

DISPLAY	
Type of display	LCD backlighted
Digit height	6/9mm
Energy resolution	depending on the CT ratio **

MECHANICAL FEATURES	
Housing	flush mounting (panel cutout 92x92mm)
Front frame	96x96mm
Housing material	self-extinguishing polycarbonate
Protection degree	IP20 terminals/ IP54 front frame
Connections type	screw terminals
Rigid cable	max 4,5mm ²
Flexible cable	max 2,5mm ²

ENVIRONMENTAL CONDITIONS	
Nominal temperature range	-5...55°C
Limit range for storage and transport	-25...70°C
Suitable for tropical climates	yes
Max.power dissipation*	≤5W

* for switchboard thermal calculation

** kCT	MAXIMUM DISPLAY
1...9	999999,99kWh/kvarh
10...99	9999999,9kWh/kvarh
100...999	99999999kWh/kvarh
1000...9999	999999,99MWh/Mvarh

Output

ENERGY PULSES S0 EN/IEC 62053-31	
Type	Optorelay with potential-free
Contact range	27 Vcc/ca-50mA
Assignable energy	Active or reactive energy
Pulse weight	selectable 10Wh/Varh...10MWh/MVarh
Pulse duration	selectable from 50 to 500ms

RS485 COMMUNICATION	
Protocol	MODBUS RTU/TCP
Standard	RS485-3-wire
Baud rate	selectable 4800...38400 bit/s

Multifunction meters

Selection table

■ Dimensions

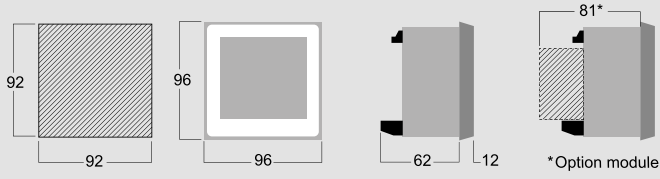

■ Wiring diagrams

Single phase network

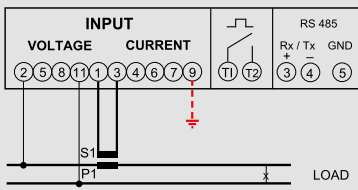

3-phase network, 4 wire

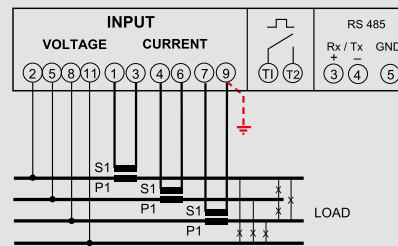

Multifunction meters

Flush mounting multifunction for low voltage



Connection via CT for single and three-phase network, 3 or 4-wires. Phase sequence correction, diagnostic. Can be accessorised with an additional module. It makes available active or reactive energy counting of the pulse output to integration of consumption supervision systems. For supervision systems, through the model with output RS485 communication ModbusRTU, you can transmit on the network main electrical parameters in addition to the energy consumption.

Functions

- Phase and linked voltage
- Min. and max. phase voltage
- THDV
- Voltage Harmonic analysis
- Voltage crest factor
- Neutral and phase current
- Current demand and current max. demand
- Average current
- THDI
- Current Harmonic analysis
- Current crest factor
- Active, reactive phase power
- Power demand and power max. demand
- Positive and negative active and reactive energy
- Power factor
- Frequency
- Run hour meter, count start with voltage or power present

Cat. Nos.	Nemo 96 HDLe			
	Input (A)	Input* (V)	Auxiliary supply	Output
MF96411	1 + 5	80...500	80...265Vac 100...300Vdc	Pulse + 1 additional modules
MF96412	1 + 5	80...500	16...60Vdc	Pulse + 1 additional modules
MF96421	1 + 5	80...500	80...265Vac 100...300Vdc	Pulse + RS485 ModBus RTU/TCP + 1 additional modules
MF96422	1 + 5	80...500	16...60Vdc	Pulse + RS485 ModBus RTU/TCP + 1 additional modules

* Three-phase input 80...500V, Single -phase input 50...290V

Cat. Nos.	Additional modules
	Descriptions
IF96001	Module RS485 Modbus RTU/TCP
IF96012	Module RS485 Modbus RTU/TCP + memory
IF96002	Module RS232 Modbus RTU/TCP
IF96007A	Module Profibus EN50170 - DP0
IF96009	Module LonWorks
IF96013	Module M-Bus EN1434-3
IF96014	Module RS485 BACnet MS-TP
IF96015	Module Ethernet

Technical features

TECHNICAL NOTES	NT854
INPUT	
Three-phase voltage (V)	80...500 (phase-phase)
Single-phase voltage (V)	50...290V
Current rating	1A - 5A
External CT ratio	max 50kA/5A - max 10kA/1A
External VT ratio	primary voltage max 1200V
Continuous overload	1,2In
Istantaneous overload	20Imax/0,5s
Reference frequency	50Hz – 400Hz (automatic selection)
Frequency tolerance	45...65Hz (fn 50Hz) – 360...440Hz (fn 400Hz)
Type of measurement	true RMS
Harmonic content	up to the 50th harmonics
Voltage rated burden (VA)	≤ 0,1VA (phase-neutral)
Current rated burden (VA)	≤ 1VA (for phase)
AUXILIARY SUPPLY	
Rated value Uaux	80...265Vac
Reference frequency	50 or 400Hz (automatic selection)
Frequency tolerance	45...65Hz (fn 50Hz) or 360...440Hz (fn 400Hz)
Rated burden	≤ 2,5VA (230Vac backlight 30% without external modules)
Rated value Uaux	100...300Vdc
Rated burden	≤ 3,5W (without modules, 110Vdc)
ACCURACY	
CONFORMITY ACCURACY WITH EN/IEC 61557-12	- voltage: cl.0,5 - Current: cl. 0,5 - Active energy: cl.0,5 - Reactive energy cl.1 - Active power cl.05 - Reactive power cl.1 - Apparent power cl.1 - Frequency ± 0,1Hz - THD cl.1
DISPLAY	
Type of display	LCD backlighted
Digit height	8/12mm
Energy resolution	depending on the CT/VT ratio**
MECHANICAL FEATURES	
Housing	flush mounting (panel cutout 92x92mm)
Front frame	96x96mm
Housing material	self-extinguishing polycarbonate
Protection degree	IP20 terminals/ IP54 front frame
Connections type	screw terminals
Rigid cable	max 4,5mm ²
Flexible cable	max 2,5mm ²
ENVIRONMENTAL CONDITIONS	
Nominal temperature range	-5...55°C
Limit range for storage and transport	-25...70°C
Suitable for tropical climates	yes
Max.power dissipation*	≤5W
* for switchboard thermal calculation	
** kCT*kVT	MAXIMUM DISPLAY
1...9	999999,99kWh/kvarh
10...99	9999999,9kWh/kvarh
100...999	99999999kWh/kvarh
1000...9999	999999,99MWh/Mvarh
10000...99999	9999999,9MWh/Mvarh
Output	
ENERGY PULSES S0 EN/IEC 62053-31	
Type	Optorelay with potential-free
Contact range	27 Vcc/ca-50mA
Assignable energy	Active or reactive energy
Pulse weight	selectable 10Wh/Varh...10MWh/MVarh
Pulse duration	selectable from 50 to 500ms
RS485 COMMUNICATION	
Protocol	MODBUS RTU/TCP
Standard	RS485-3-wire
Baud rate	selectable 4800...38400 bit/s
ADDITIONAL MODULES	
N. max installable module	1
Installation position	A

Multifunction meters

Flush mounting multifunction for low voltage

Dimensions

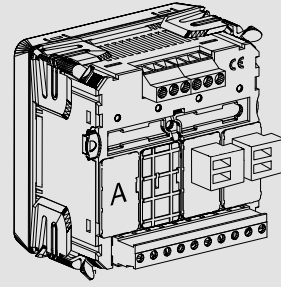
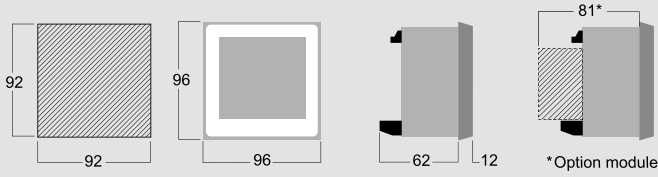

Wiring diagrams

Single phase network

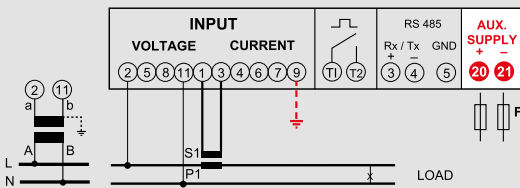

3-phase network, 3 wire

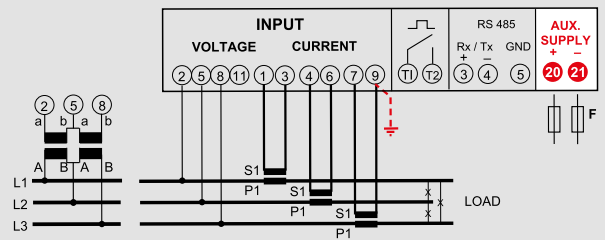

3-phase network, 3 wire, 1 System

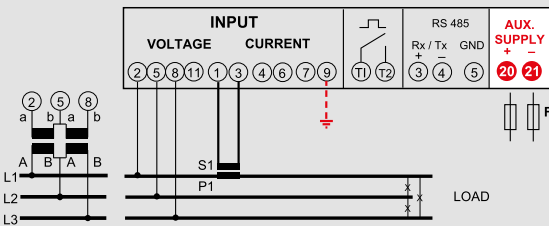

3-phase network, 4 wire

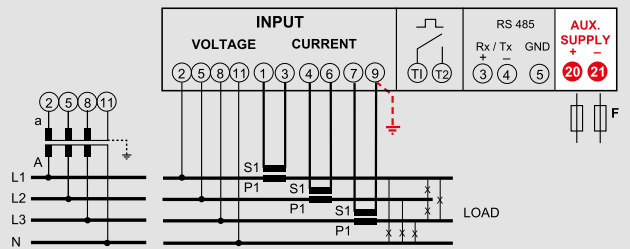

3-phase network, 4 wire, 1 System

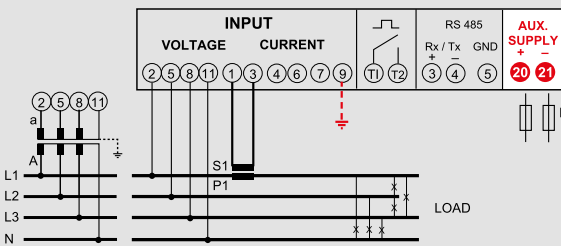

3-phase network, 3 wire

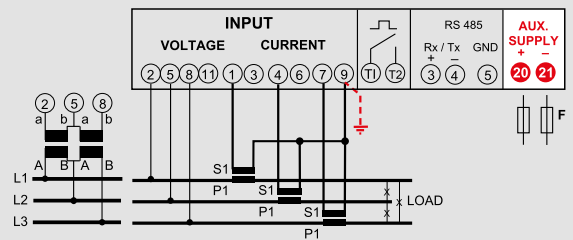

3-phase network, 4 wire (ARON L1-L3)

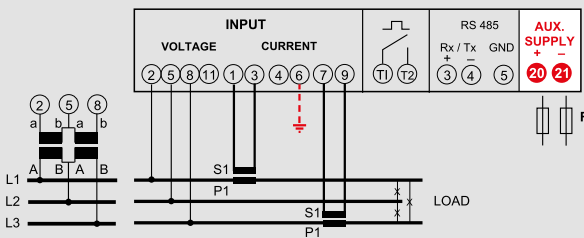

3-phase network, 4 wire

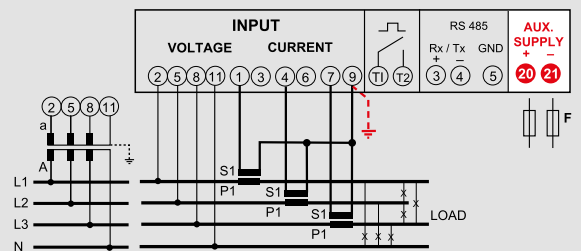

Multifunction meters

Flush mounting multifunction for low voltage



Connection via dedicated Rogowski coils for single and three-phase network, 3 or 4-wires
 Can be accessorised with an additional modules.
 It makes available active or reactive energy counting of the pulse output to integration of consumption supervision systems.
 For supervision systems, through the model with output RS485 communication ModbusRTU, you can transmitted on the network main electrical parameters in addition to the energy consumption.

Functions

- Phase and linked voltage
- Min. and max. phase voltage
- THDV
- Voltage Harmonic analysis
- Voltage crest factor
- Neutral and phase current
- Current demand and current max. demand
- Average current
- THDI
- Current Harmonic analysis
- Current crest factor
- Active, reactive phase power
- Power demand and power max. demand
- Positive and negative active and reactive energy
- Power factor
- Frequency
- Run hour meter, count start with voltage or power present

Cat. Nos.	KIT Nemo 96 HDLe + 3 Rogowski coils			
	Input (A) /RC**	Input* (V)	Auxiliary supply	Output
KRNEMOHDLE080	from Rogowsky sensor Ø 80mm	80...500	80...265Vac 110...300Vdc	Pulse + RS485 ModBus RTU/TCP + 1 additional modules
KRNEMOHDLE142	from Rogowsky sensor Ø 142mm	80...500	80...265Vac 110...300Vdc	Pulse + RS485 ModBus RTU/TCP + 1 additional modules
KRNEMOHDLE190	from Rogowsky sensor Ø 190mm	80...500	80...265Vac 110...300Vdc	Pulse + RS485 ModBus RTU/TCP + 1 additional modules

* Three-phase input 80...500V, Single -phase input 50...290V
 ** 3 selectable current range: 20...1000A, 60...3000A, 100...5000A

Cat. Nos.	Additional modules
	Descriptions
IF96001	Module RS485 Modbus RTU/TCP
IF96012	Module RS485 Modbus RTU/TCP + memory
IF96002	Module RS232 Modbus RTU/TCP
IF96007A	Module Profibus EN50170 - DP0
IF96009	Module LonWorks
IF96013	Module M-Bus EN1434-3
IF96014	Module RS485 BACnet MS-TP
IF96015	Module Ethernet

Technical features

TECHNICAL NOTES	NT890
INPUT	
Three-phase voltage (V)	80...500 (phase-phase)
Single-phase voltage (V)	50...290V
Current rating	20...1000A, 60...3000A, 100...5000A
External VT ratio	primary voltage max 1200V
Continuous overload	1,2In
Istantaneous overload	20Imax/0,5s
Reference frequency	50Hz
Frequency tolerance	45...65Hz (fn 50Hz)
Type of measurement	true RMS
Harmonic content	up to the 50th harmonics
Voltage rated burden (VA)	≤ 0,1VA (phase-neutra)
Current rated burden (VA)	≤ 1VA (for phase)
AUXILIARY SUPPLY	
Rated value Uaux	80...265Vac
Reference frequency	50 or 400Hz (automatic selection)
Frequency tolerance	45...65Hz (fn 50Hz) or 360...440Hz (fn 400Hz)
Rated burden	≤ 2,5VA (230Vac backlight 30% without external modules)
Rated value Uaux	100...300Vdc
Rated burden	≤ 3,5W (without modules, 110Vdc)
ACCURACY	
CONFORMITY ACCURACY WITH EN/IEC 61557-12	- voltage: cl.0,5 - Current: cl. 0,5 - Active energy: cl.1 - Reactive energy cl.1 - Active power cl.05 - Reactive power cl.1 - Apparent power cl.1 - Frequency ± 0,1Hz - THD cl.1
DISPLAY	
Type of display	LCD backlighted
Digit height	8/12mm
Energy resolution	depending on the RC/VT ratio**
MECHANICAL FEATURES	
Housing	flush mounting (panel cutout 92x92mm)
Front frame	96x96mm
Housing material	self-extinguishing polycarbonate
Protection degree	IP20 terminals/ IP54 front frame
Connections type	screw terminals
Rigid cable	max 4,5mm ²
Flexible cable	max 2,5mm ²
ENVIRONMENTAL CONDITIONS	
Nominal temperature range	-5...55°C
Limit range for storage and transport	-25...70°C
Suitable for tropical climates	yes
Max.power dissipation*	≤5W
* for switchboard thermal calculation	
** kRCx kVT	MAXIMUN DISPLAY
200...999	99999999kWh/kvarh
1000...9999	999999,99MWh/Mvarh
kRC = 200 for range 200...1000A	
= 600 for range 600...3000A	
= 1000 for range 100...5000A	
Output	
ENERGY PULSES S0 EN/IEC 62053-31	
Type	Optorelay with potential-free
Contact range	27 Vcc/ca-50mA
Assignable energy	Active or reactive energy
Pulse weight	selectable 10Wh/Varh...10MWh/MVarh
Pulse duration	selectable from 50 to 500ms
RS485 COMMUNICATION	
Protocol	MODBUS RTU/TCP
Standard	RS485-3-wire
Baud rate	selectable 4800...38400 bit/s
ADDITIONAL MODULES	
N. max installable module	1
Installation position	A

Multifunction meters

Flush mounting multifunction for low voltage

Dimensions

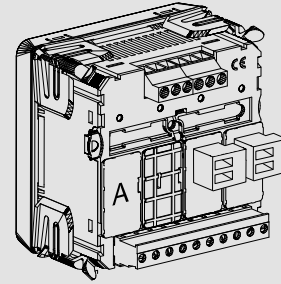
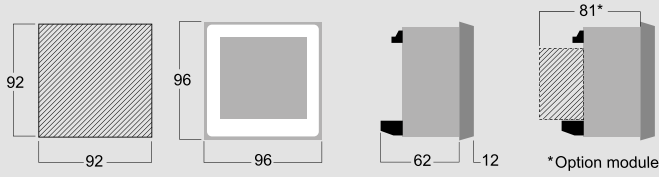

Wiring diagrams

Single phase network

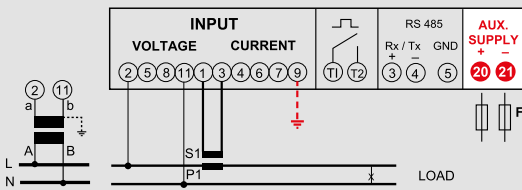

3-phase network, 3 wire

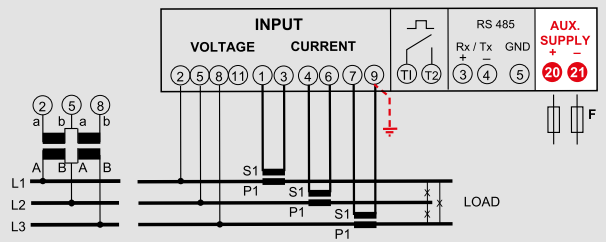

3-phase network, 3 wire, 1 System

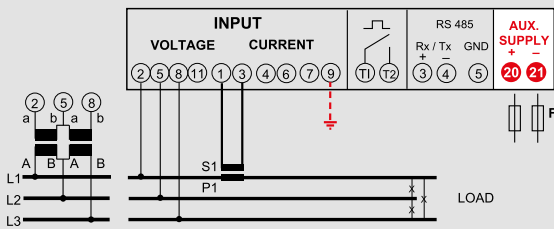

3-phase network, 4 wire

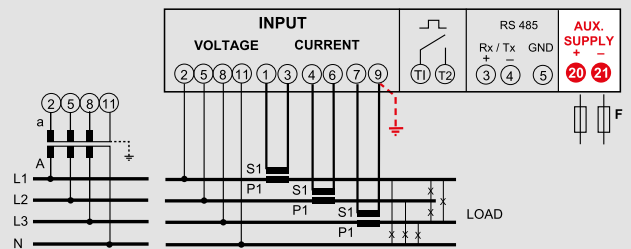

3-phase network, 4 wire, 1 System

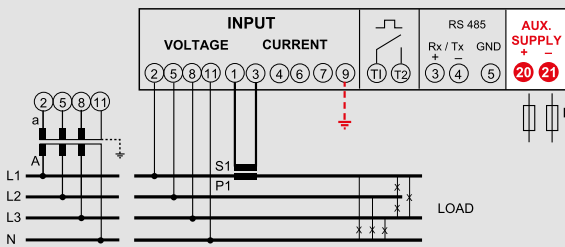

3-phase network, 4 wire (ARON L1-L3)

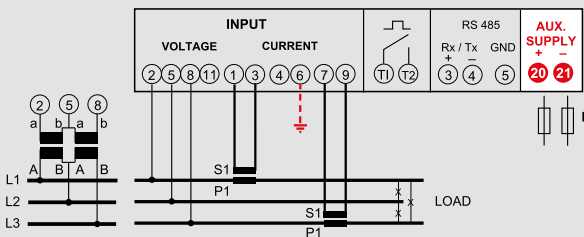

Multifunction meters

Flush mounting multifunction for low voltage

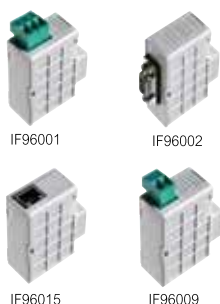

Connection via CT for single and three-phase network, 3 or 4-wires. Phase sequence correction, diagnostic. Can be accessorised with up to 4 additional modules.

Functions

- Phase and linked voltage
- Min. and max. phase voltage
- THDV
- Neutral and phase current
- Current demand and current max. demand
- Average current
- THDI
- Active, reactive phase power
- Power demand and power max. demand
- Positive and negative active and reactive energy
- Power factor
- Frequency
- Run hour meter, count start with voltage or power present

Cat. Nos.	Nemo 96 HD			
	Input (A)	Input* (V)	Auxiliary supply	Output
MF96001	1 + 5	80...500	80...265Vac 100...300Vdc	up 4 additional modules
MF96002	1 + 5	80...500	16...60Vdc	up 4 additional modules

* Three-phase input 80...500V, Single -phase input 50...290V

Cat. Nos.	Additional modules
	Descriptions
IF96001	Module RS485 Modbus RTU/TCP
IF96012	Module RS485 Modbus RTU/TCP + memory
IF96002	Module RS232 Modbus RTU/TCP
IF96007A	Module Profibus EN50170 - DP0
IF96009	Module LonWorks
IF96013	Module M-Bus EN1434-3
IF96014	Module RS485 BACnet MS-TP
IF96015	Module Ethernet
IF96003	Module with 2 energy pulse outputs (SPST)
IF96004	Module with 2 x 0/4..20mA analogue outputs
IF96005	Module with 2 alarm relay outputs (SPST)
IF96006	Neutral current measurement from CT /1A or 5A programmable
IF96016	Module temperature measurement 2 inputs from PT100
IF96010	Module with 2 input SPST-NO 2 relay outputs SPST-NO
IF96011	Module with 2 input 12/24Vcc 2 relay outputs SPST-NO

Technical features

TECHNICAL NOTES	NT680
INPUT	
Three-phase voltage (V)	80...500 (phase-phase)
Single-phase voltage (V)	50...290V
Current rating	1A - 5A
External CT ratio	max 50kA/5A - max 10kA/1A
External VT ratio	primary voltage max 1200V
Continuous overload	1,2In
Istantaneous overload	20Imax/0,5s
Reference frequency	50Hz
Frequency tolerance	45...63Hz
Type of measurement	true RMS
Voltage rated burden (VA)	≤ 0,1VA (phase-neutral)
Current rated burden (VA)	≤ 1VA (for phase)
AUXILIARY SUPPLY	
Rated value Uaux	80...265Vac
Reference frequency	50
Frequency tolerance	45...63Hz
Rated burden	≤ 2,5VA (230Vac backlight 30% without external modules)
Rated value Uaux	100...300Vdc 11...60Vdc
Rated burden	≤ 3,5W (without modules)
ACCURACY	
CONFORMITY ACCURACY WITH EN/IEC 61557-12	- Voltage: cl.0,5 - Current: cl. 0,5 - Active energy: cl.0,5 - Reactive energy cl.2 - Active power cl.0,5 - Reactive power cl.1 - Apparent power cl.1 - Frequency cl.0,5 - Power factor cl.0,5 - THD cl.2
DISPLAY	
Type of display	LCD backlighted
Digit height	12mm
Energy resolution	depending on the CT/VT ratio**
MECHANICAL FEATURES	
Housing	flush mounting (panel cutout 92x92mm)
Front frame	96x96mm
Housing material	self-extinguishing polycarbonate
Protection degree	IP20 terminals/ IP54 front frame
Connections type	screw terminals
Rigid cable	max 4,5mm ²
Flexible cable	max 2,5mm ²
ENVIRONMENTAL CONDITIONS	
Nominal temperature range	-5...55°C
Limit range for storage and transport	-25...70°C
Suitable for tropical climates	yes
Max.power dissipation*	≤5W

* for switchboard thermal calculation

** kCT*kVT	MAXIMUM DISPLAY
1...9	999999,99kWh/kvarh
10...99	9999999,9kWh/kvarh
100...999	99999999kWh/kvarh
1000...9999	999999,99MWh/Mvarh
10000...99999	9999999,9MWh/Mvarh
100000...400000	99999999MWh/Mvarh

Output

ADDITIONAL MODULES	
N. max installable module	1
Installation position	A-B-C-D

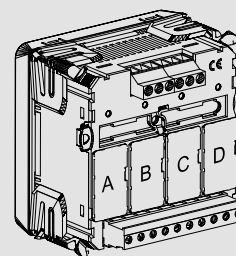

Multifunction meters

Flush mounting multifunction for low voltage

Dimensions

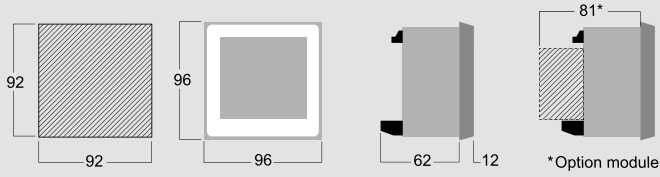

Wiring diagrams

Single phase network

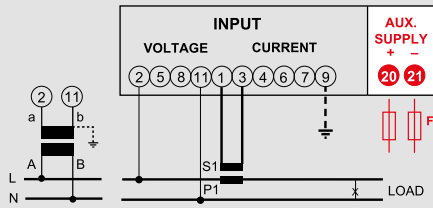

3-phase network, 4 wire (ARON L1-L3)

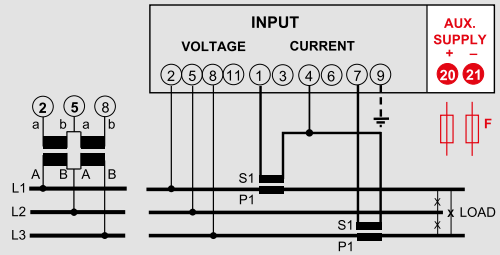

3-phase network, 3 wire, 1 System

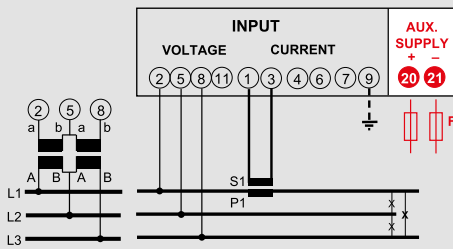

3-phase network, 3 wire

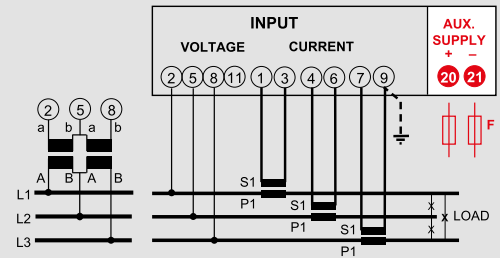

3-phase network, 4 wire, 1 System

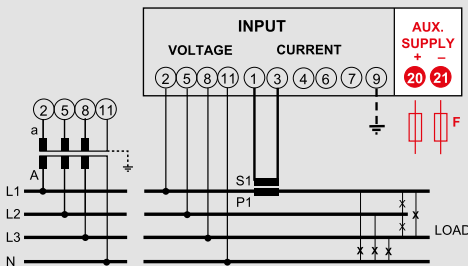

3-phase network, 4 wire

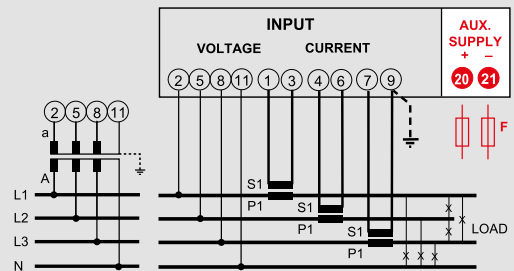

Multifunction meters

Flush mounting multifunction for low, medium and high voltage



Connection via CT for single and three-phase network, 3 or 4-wires. Phase sequence correction, diagnostic. Can be accessorised with up to 4 additional modules.

Functions

- Phase and linked voltage
- Min. and max. phase voltage
- THDV
- Voltage Harmonic analysis
- Voltage crest factor
- Phase angle between voltage
- Neutral and phase current
- Current demand and current max. demand
- Average current
- THDI
- Current Harmonic analysis
- Current crest factor
- Phase angle between current
- Active, reactive phase power
- Power demand and power max. demand
- Positive and negative active and reactive energy
- Power factor
- Phase angle between current and voltage
- Frequency
- Run hour meter, count start with voltage or power present

Cat. Nos.	Nemo 96 HD+			Output
	Input (A)	Input* (V)	Auxiliary supply	
MF96021A	1 + 5	80...690	80...265Vac 100...300Vdc	up 4 additional modules
MF96022A	1 + 5	80...690	16...60Vdc	up 4 additional modules

* Three-phase input 80...690, Single -phase input 230V

Cat. Nos.	Additional modules	Descriptions
IF96001		Module RS485 Modbus RTU/TCP
IF96012		Module RS485 Modbus RTU/TCP + memory
IF96002		Module RS232 Modbus RTU/TCP
IF96007A		Module Profibus EN50170 - DP0
IF96009		Module LonWorks
IF96013		Module M-Bus EN1434-3
IF96014		Module RS485 BACnet MS-TP
IF96015		Module Ethernet
IF96018 ¹		Radio transmitter module 868 MHz
IF96003		Module with 2 energy pulse outputs (SPST)
IF96004		Module with 2 x 0/4..20mA analogue outputs
IF96005		Module with 2 alarm relay outputs (SPST)
IF96006		Neutral current measurement from CT /1A or 5A programmable
IF96016		Module temperature measurement 2 inputs from PT100
IF96010		Module with 2 input SPST-NO 2 relay outputs SPST-NO

¹ Complete with power unit, pen-type steerable aerial + extension cable of 20cm. A transceiver gateway IFMTR01 must be provided. on RS485

Technical features

TECHNICAL NOTES	NT904
INPUT	
Three-phase voltage (V)	80...690 (phase-phase)
Single-phase voltage (V)	230V
Current rating	1A - 5A
External CT ratio	max 50kA/5A - max 10kA/1A
External VT ratio	primary voltage max 150kV
Continuous overload	1,2In
Istantaneous overload	20Imax/0,5s
Reference frequency	50Hz
Frequency tolerance	45...63Hz
Type of measurement	true RMS
Voltage rated burden (VA)	≤ 0,1VA (phase-neutral)
Current rated burden (VA)	≤ 0,2VA (for phase)
AUXILIARY SUPPLY	
Rated value Uaux	80...265Vac
Reference frequency	50
Frequency tolerance	45...63Hz
Rated burden	≤ 2,5VA (230Vac backlight 30% without external modules)
Rated value Uaux	100...300Vdc 11...60Vdc
Rated burden	≤ 3,5W (without modules)
ACCURACY	
CONFORMITY ACCURACY WITH EN/IEC 61557-12	- voltage: cl.0,5 - Current: cl. 0,5 - Active energy: cl.0,5 - Reactive energy cl.2 - Active power cl.05 - Reactive power cl.1 - Apparent power cl.1 - Frequency cl.0,5 - Power factor cl.0,5 - THD cl.2
DISPLAY	
Type of display	LCD backlighted
Digit height	8/12mm
Energy resolution	depending on the CT/VT ratio**
MECHANICAL FEATURES	
Housing	flush mounting (panel cutout 92x92mm)
Front frame	96x96mm
Housing material	self-extinguishing polycarbonate
Protection degree	IP20 terminals/ IP54 front frame
Connections type	screw terminals
Rigid cable	max 4,5mm ²
Flexible cable	max 2,5mm ²
ENVIRONMENTAL CONDITIONS	
Nominal temperature range	-5...55°C
Limit range for storage and transport	-25...70°C
Suitable for tropical climates	yes
Max.power dissipation*	≤5W

* for switchboard thermal calculation

** kCT*kVT	MAXIMUM DISPLAY
1...9	999999,99kWh/kvarh
10...99	9999999,9kWh/kvarh
100...999	99999999kWh/kvarh
1000...9999	999999,99MWh/Mvarh
10000...99999	9999999,9MWh/Mvarh
100000...400000	99999999MWh/Mvarh

Output

ADDITIONAL MODULES	
N. max installable module	1
Installation position	A-B-C-D

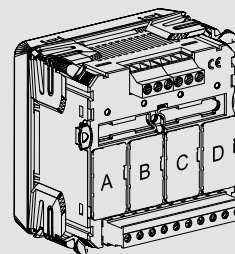

Multifunction meters

Flush mounting multifunction for low, medium and high voltage

Dimensions

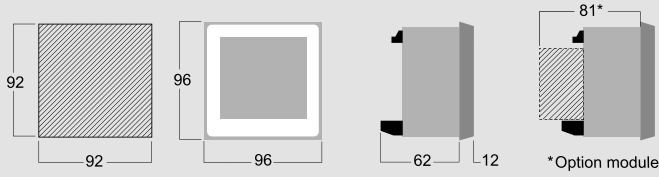

Wiring diagrams

Single phase network

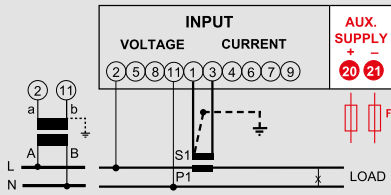

3-phase network, 3 wire

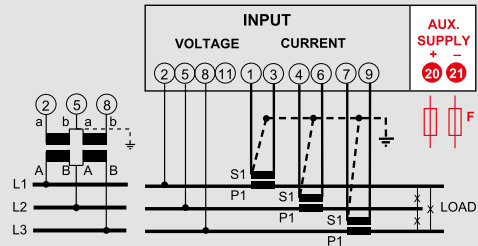

3-phase network, 3 wire, 1 System

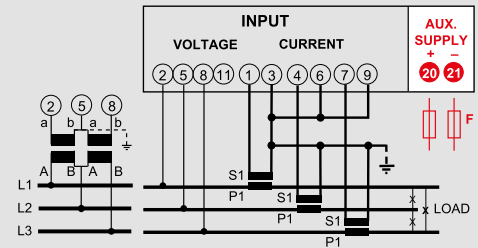
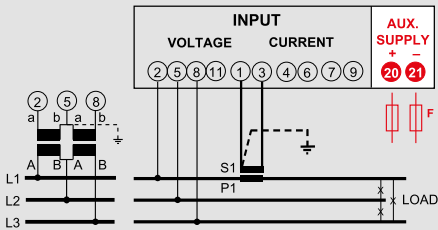

3-phase network, 4 wire, 1 System

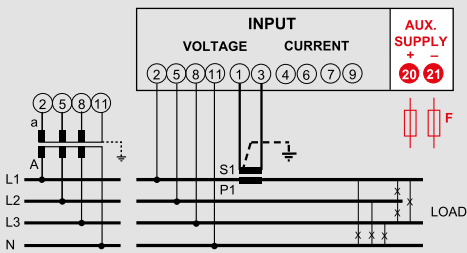

3-phase network, 4 wire

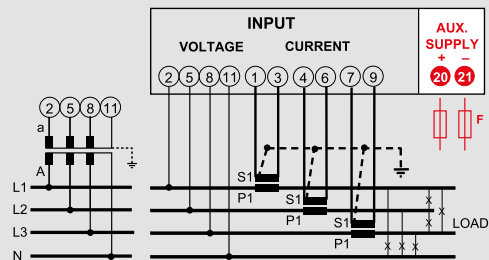

3-phase network, 4 wire (ARON L1-L3)

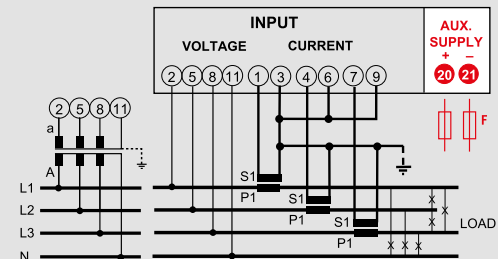
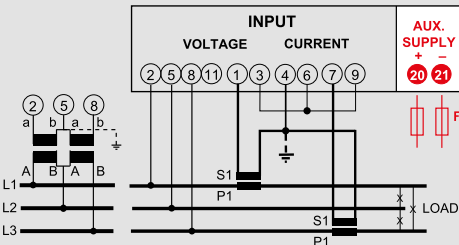

Multifunction meters

Additional modules for NEMO 96 multifunction



IF96001



IF96012



IF96002



IF96007A



IF96009



IF96013



IF96014



IF96015



IF96018



IF96003



IF96004



IF96005



IF96006



IF96016



IF96010



IF96011

Cat. Nos.

Additional modules

Descriptions

IF96001	Module RS485 Modbus RTU/TCP
IF96012	Module RS485 Modbus RTU/TCP + memory
IF96002	Module RS232 Modbus RTU/TCP
IF96007A	Module Profibus EN50170 - DP0
IF96009	Module LonWorks
IF96013	Module M-Bus EN1434-3
IF96014	Module RS485 BACnet MS-TP
IF96015	Module Ethernet
IF96018 ¹	Radio transmitter module 868 MHz
IF96003	Module with 2 energy pulse outputs (SPST)
IF96004	Module with 2 x 0/4...20mA analogue outputs
IF96005	Module with 2 alarm relay outputs (SPST)
IF96006	Neutral current measurement from CT /1A or 5A programmable
IF96016	Module temperature measurement 2 inputs from PT100
IF96010	Module with 2 input SPST-NO 2 relay outputs SPST-NO
IF96011	Module with 2 input 12/24Vcc 2 relay outputs SPST-NO



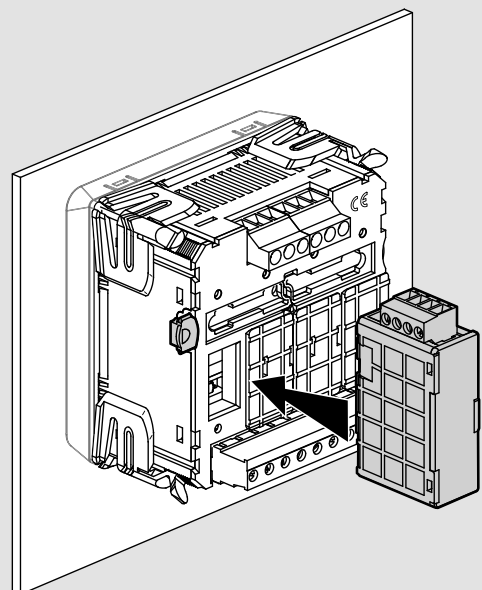
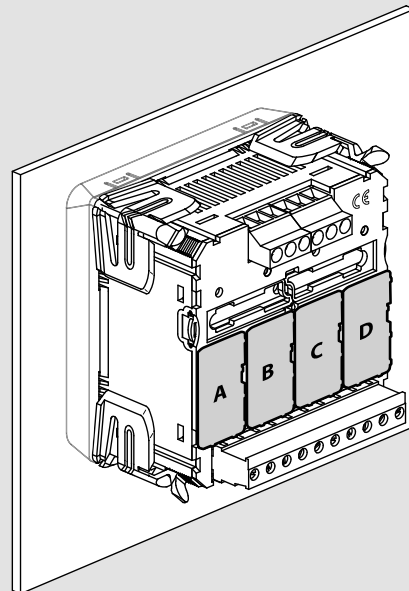

¹ Complete with power unit, pen-type steerable aerial + extension cable of 20cm. A transceiver gateway IFMTR01 must be provided. on RS485

Additional modules installation



Multifunction meters

Additional modules for NEMO 96 multifunction - Selection table

							
Cat. Nos.	Technical notes	Descriptions	n°max installable	Installation position	NEMO 96HDL E	NEMO 96HD	NEMO 96HD+
COMMUNICATION MODULES ¹							
IF96001	NT675	RS485 Modbus RTU/TCP	1	A	•	•	•
IF96012	NT704	RS485 Modbus RTU/TCP + memory	1	A	•	•	•
IF96002	NT676	RS232 Modbus RTU/TCP	1	A	•	•	•
IF96007A	NT682	Profibus EN50170 - DP0	1	A	•	•	•
IF96009	NT684	LonWorks	1	A	•	•	•
IF96013	NT707	M-Bus EN1434-3	1	A	•	•	•
IF96014	NT743	RS485 BACnet MS-TP	1	A	•	•	•
IF96015	NT785	Ethernet	1	A	•	•	•
IF96018 ²	NT856	Radio transmitter module 868 MHz	1	A			•
OUTPUT MODULES							
IF96003	NT677	2 energy pulse outputs (SPST)	2	A - B - C - D		•	•
IF96004	NT678	2 x 0/4...20mA analogue outputs	2	C - D		•	•
IF96005	NT679	2 alarm relay outputs (SPST)	2	A - B - C - D		•	•
MEASUREMENT MODULES							
IF96006	NT683	Neutral current measurement from CT /1A or 5A programmable	1	C		•	•
IF96016	NT810	Temperature measurement 2 inputs from PT100	1	D		•	•
I/O MODULE							
IF96010	NT702	2 input SPST-NO 2 relay outputs SPST-NO	2	C - D		•	•
IF96011	NT703	2 input 12/24Vcc 2 relay outputs SPST-NO	2	C - D		•	

¹ Communication modules are as an alternative to them

² Complete with power unit, pen-type steerable aerial + extension cable of 20cm. A transceiver gateway IFMTR01 must be provided. on RS485

STATIC ENERGY METERS CONTO

► NEW ◀

New Conto D6
Static meter for direct
connection up to 125A



► Energy meters

one-way multi measure, also
suitable for tax purposes
applications.

The LCD display, show active
energy consumption (kWh)
Class 1 EN/IEC 62053-21 or EN
50470 certified class B MID, and
reactive (kvarh) Class 2 EN/IEC
62053-23 addition to the main
electrical parameters.



MID certification

Conto static meter guarantees accuracy and reliability of measurement, and thanks to european directive homologation 2004/22/CE MID (Measuring Instruments Directive), can be used for tax purposes.

The static meter are equipped by tamper-proof components to prevent fraud or access to some functions (no reset).

Direct measurement up to 125 A

Direct measurement for currents up to 125 A, singlephase and three-phase, indirect measurement via current transformers for currents from 125 A and up to 6000 A:

Energy management

Thanks to models with pulse outputs or RS485 communications, ModBus RTU or M-Bus, energy meters are easily integrated into main system of centralized monitoring and thanks to the ethernet interface with web server function is possible to integrate in a remote control system such as MIDAS Evo.

Selection table

Model conto		D1 MID	D2 MID	D4-Pd MID	D4-Pt MID	
Network		LV	LV	LV	LV/MV	
Connection		Direct			CT	
Technical notes		NT867	NT788	NT789	NT742	
INPUT	Connection	1Ph	•	•		
		3Ph balanced load				
		3Ph unbalanced load			•	•
		3Ph+N unbalanced load			•	•
	Rated value	Direct single phase voltage	230V	230V		
		VT single phase voltage				
		Direct three-phase voltage			400V	400V
		VT three-phase voltage				100V
		Basic current (I _b)	5A	10A	10A	5A
		Max. current (I _{max})	45A	63A	63A	6A
Programmable Ratio	Starting current	20mA	40mA	40mA	10mA	
	VT (kVT) ¹				1...500	
	CT (kCT) ¹				1...1.999	
	max. kVT x kCT				1.000.000	
DISPLAY	Active energy	Accuracy EN/IEC62053-21				
		Accuracy EN50470	cl.B	cl.B	cl.B	cl.B
		Total to terminals	•MID	•MID	•MID	•MID
		Total to primary side				•
		Partial resettable		•	•	
	Reactive energy	Double tariff				
		Accuracy EN/IEC62053-23			cl.2	cl.2
		Total to primary side			•	•
		Partial resettable			•	
	Voltage	Double tariff				
		Phase		•	•	•
	Current	Linked			•	•
		Phase		•	•	•
	Power factor	Neutral				•
				•	•	•
	Power	Active		•	•	•
		Reactive			•	•
		Apparent			•	•
		Phase Active and reactive			•	•
		Peak max. demand			•	•
Frequency			•	•	•	
Run hour meter			•	•	•	
OUTPUT	Pulse	•	▲	▲	•	
	RS485 MODBUS RTU		■	■	•	
	RS232		• ²	• ²	• ²	
	M-BUS			•		
	Ethernet		• ³	• ³	• ³	
Auxiliary supply				•		
Self-supplied	•	•	•			
Mid certifications		•	•	•		
UTF certifications (italia only)		•	•	•		
Dimensions			2 modules	4 modules	4 modules	









1 kVT/ kCT transformations ratio to CT and VT defined as the mathematical ratio between the primary and secondary value.
 Example: kVT of a transformer 1000/100V = 1000:100 = 10
 kCT of a transformer 800/5A = 800:5 = 160

2 With interface (see page 62)

3 With interface (see page 62)

Static Energy Meters

Selection table

									
	D1	D1	D2-b	D2	D4-Pd	D6-Pd	D4-Pt	D4-Sh	72-Pt / 96-Pt
	LV	LV	LV	LV	LV	LV	LV/MV	LV/MV	LV/MV
	Direct						CT	CT	CT
	NT784	NT868	NT660	NT765	NT880	NT902	NT672	NT739	NT697 / NT698
	•	•	•	•	•		•	•	•
							•	•	•
							•	•	•
							•	•	•
	230V	230V	230-240V	230-240V			230-240V	230-240-254V	230-240V
							100-110V	100-110V	100-110V
					400-415V	400-415V	400-415V	400-415-440V	400-415V
							100-110V	100-110V	100-110V
	5A	5A	5A	5A	10A	20A	1-5A	1-5A	1-5A
	32A	45A	36A	63A	63A	125A	6A	6A	6A
	20mA	20mA	20mA	20mA	40mA	80mA	20mA	20mA	20mA
							1...1.500		1...1.500
							1...1.999	1...1.999	1...1.999
							5.000.000 (1A)	5.000.000 (1A)	5.000.000 (1A)
							1.000.000 (5A)	1.000.000 (5A)	1.000.000 (5A)
	cl.1	cl.1	cl.1	cl.1	cl.1	cl.1	cl.1	cl.1	cl.1
	•	•	•	•	•		•	•	•
				•	▲	▲	•	•	•
					■	■	•	•	•
					cl.2	cl.2	cl.2	cl.2	cl.2
					•	•	•	•	•
					▲	▲	•	•	•
					■	■			
		•		•	•	•	•	•	•
		•		•	•	•	•	•	•
		•		•	•	•	•	•	•
		•		•	•	•	•	•	•
		•		•	•	•	•	•	•
		•		•	•	•	•	•	•
		•		•	•	•	•	•	•
		•		•	•	•	•	•	•
		•		•	•	•	•	•	•
	•			▲	▲	▲	•	•	•
		•		■	■	■	•	•	•
		• ²		• ²	• ²	• ²	• ²	• ²	• ²
		• ³		• ³	• ³	• ³	• ³	• ³	• ³
	•	•	•	•	•	•	•	•	•
	1 module		2 modules	2 modules	4 modules	6 modules	4 modules	4 modules	72x72mm / 96x96mm

■ / ▲ alternatively



Static Meter with MID certification
 Direct connection for single-phase network.
 It makes available active energy counting of the pulse output to integration of consumption supervision systems.

Functions

- Total Active Energy

Cat. Nos.	Conto D1 MID		
		Network	Output
CE1DMID12		1Ph+N	Pulse

Technical features

TECHNICAL NOTES	NT867
INPUT CURRENT	
Starting current (Ist)	0,02A
Min. current (Imin)	0,25A
Basic current (Ib)	5A
Max. current (Imax)	45A
Short-time overcurrent	30Imax/10ms
Power consumption	2W / 10VA
INPUT VOLTAGE	
Reference single-phase voltage	230V
Specified operating range	+ - 15%
NETWORK	
Reference frequency	50-60Hz
Frequency tolerance	49...51-59...61Hz
AUXILIARY SUPPLY	
Nominal voltage	Taken from measurement (self-supplied)
ACCURACY	
Active energy kWh EN50470	cl. B
DISPLAY	
Type	Backlit LCD
Digit height	6mm
Energy resolution	9999,99 kWh
MECHANICAL FEATURES	
Housing	1 module DIN 43880 (35mm)
Housing material	self-extinguishing polycarbonate
Protection degree	IP20 terminals/ IP51 front frame
Sealable terminals	Yes
Connections type	screw terminals
Cable with lag	output - max 7mm ² input - max 10mm ²
Flexible cable	output - max 4mm ² input - max 7mm ²
ENVIRONMENTAL CONDITIONS	
Nominal temperature range	-5...55°C
Limit range for storage and transport	-25...70°C
Suitable for tropical climates	yes
Max.power dissipation*	≤1W

*For switchboard thermal calculation

Output

ENERGY PULSES S0 EN/IEC 62053-31	
Type	Optorelay with potential-free
Contact range	27Vdc/ac-27mA
Assignable energy	Active energy
Pulse weight	1 imp/Wh
Pulse duration	70ms

Wiring diagrams

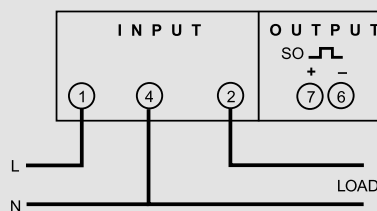

Static Energy Meters

Static meter 63 A direct connection



Static Meter with MID certification
 Direct connection for single-phase network.
 It makes available active energy counting of the pulse output to integration of consumption supervision systems.
 For supervision systems, through the model with output RS485 communication Modbus RTU, you can transmitted on the network main electrical parameters in addition to the energy consumption.

Functions

- Total active energy (MID)
- Partial active energy
- Current / Voltage
- Active power
- Frequency
- Power factor
- Run hour meter (count start with current $\geq 40\text{mA}$)

Cat. Nos.	Conto D2 MID	
CE2DMID11	Network 1Ph+N	Output RS485 ModBus RTU
CE2DMID12	1Ph+N	Pulse

Technical features

TECHNICAL NOTES	NT788
INPUT CURRENT	
Starting current (Ist)	0,04A
Min. current (Imin)	0,5A
Basic current (Ib)	10A
Max. current (Imax)	63A
Short-time overcurrent	30Imax/10ms
Power consumption	1,5W / 4VA
INPUT VOLTAGE	
Reference single-phase voltage	230V
Specified operating range	$\pm 10\%$
NETWORK	
Reference frequency	50-60Hz
Frequency tolerance	49...51-59...61Hz
AUXILIARY SUPPLY	
Nominal voltage	Taken from measurement (self-supplied)
ACCURACY	
Active energy kWh EN50470	cl. B
DISPLAY	
Type	Backlit LCD
Digit height	6mm
Energy resolution	99999,9 kWh
MECHANICAL FEATURES	
Housing	2 module DIN 43880 (35mm)
Housing material	self-extinguishing polycarbonate
Protection degree	IP20 terminals/ IP51 front frame
Sealable terminals	Yes
Connections type	screw terminals
Cable with lag	output - max 4mm ² input - max 16mm ²
Flexible cable	output - max 2,5mm ² input - max 10mm ²
ENVIRONMENTAL CONDITIONS	
Nominal temperature range	-5...55°C
Limit range for storage and transport	-25...70°C
Suitable for tropical climates	yes
Max.power dissipation*	$\leq 4\text{W}$

*For switchboard thermal calculation

Output

ENERGY PULSES S0 EN/IEC 62053-31	
Type	Optorelay with potential-free
Contact range	27Vdc/ac – 50mA
Assignable energy	Active energy
Pulse weight	selectable 1Wh...1kWh
Pulse duration	selectable 50...500ms
RS485 COMMUNICATION	
Protocol	MODBUS RTU
Standard	RS485-3-wire
Baud rate	selectable 2400...19200 bit/s

Wiring diagrams

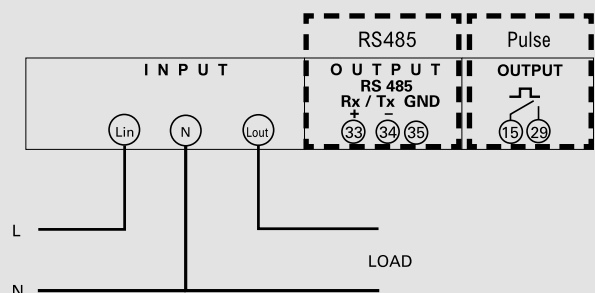



Static Meter with MID certification

Direct connection for three-phase network, 3 or 4-wires.

It makes available active or reactive energy counting of the pulse output to integration of consumption supervision systems.

For supervision systems, through the model with output RS485 communication Modbus RTU or M-Bus, you can transmitted on the network main electrical parameters in addition to the energy consumption.

Functions

- Active energy (MID)
- Reactive energy
- Partial positive, active and reactive energy
- Current / Voltage
- Frequency
- Power factor
- Active, reactive and apparent power, phase active and reactive power, active power demand and active power max. demand
- Run hour meter (count start with minimum currents)

Cat. Nos.	Conto D4 - Pd MID	
	Network	Output
CE4DMID21	3Ph	RS485 ModBus RTU
CE4DMID22	3Ph	Pulse
CE4DMID31	3Ph + N	RS485 ModBus RTU
CE4DMID32	3Ph + N	Pulse
CE4DMID3M	3Ph + N	M-bus output

Cat. Nos.	Accessories
	Description
AVKIT4	Wall mounting adapter (103x72mm)
AVKIT4Q	Wall mounting adapter (96x96mm)

Wiring diagrams

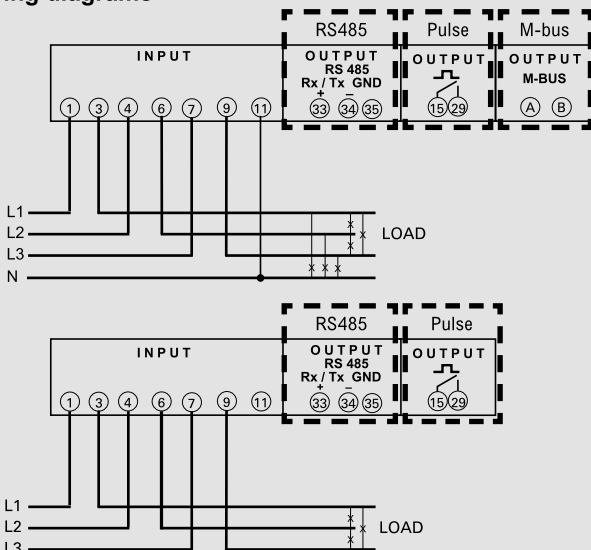

Technical features

CAT.NOS	CE4DMID21/22 CE4DMID31/32	CE4DMID3M
TECHNICAL NOTES	NT789	NT887
INPUT CURRENT		
Starting current (Ist)	0,04A	
Min. current	0,5A	
Basic current (Ib)	10A	
Max. current (Imax)	63A	
Short-time overcurrent	20Imax/0,5s	30Imax/0,5s
Power consumption	2,2VA /1,5W three-phase	
INPUT VOLTAGE		
Reference three-phase voltage	230-400V	400V
Specified operating range	± 15%	
NETWORK		
Reference frequency	50Hz	
Frequency tolerance	49...61Hz	
AUXILIARY SUPPLY		
Nominal voltage	Taken from measurement (self-supplied)	
ACCURACY		
Active energy kWh EN50470	cl. B	
Reactive energy kvarh EN/IEC 62053-23	cl. 2	
DISPLAY		
Type	Backlit LCD	
Digit height	6mm	
Energy resolution	999999,99 kWh/kvarh	
MECHANICAL FEATURES		
Housing	4 module DIN 43880 (35mm)	
Housing material	self-extinguishing polycarbonate	
Protection degree	IP20 terminals/ IP52 front frame	
Sealable terminals	Yes	
Connections type	screw terminals	
Cable with lag	output - max 4mm ² input - max 16mm ²	
Flexible cable	output - max 2,5mm ² input - max 10mm ²	
ENVIRONMENTAL CONDITIONS		
Nominal temperature range	-25...55°C	
Limit range for storage and transport	-40...70°C	
Suitable for tropical climates	yes	
Max.power dissipation*	≤6W	

*For switchboard thermal calculation

Output

ENERGY PULSES S0 EN/IEC 62053-31	
Type	Optorelay with potential-free
Contact range	27Vdc/ac – 50mA
Assignable energy	Active or reactive energy
Pulse weight	selectable 1Wh/varh...10KkWh/kvarh
Pulse duration	selectable 50...500ms
RS485 COMMUNICATION	
Protocol	MODBUS RTU
Standard	RS485-3-wire
Baud rate	selectable 4800...19200 bit/s
M-BUS COMMUNICATION	
Protocol	M-BUS
Standard	EN13757
Baud rate	selectable 300...9600 bit/s

Static Energy Meters

Static meter by CT



Static Meter with MID certification

Static meter by CT for single and three-phase network, 3 or 4-wires.

It makes available active or reactive energy counting of the pulse output to integration of consumption supervision systems.

For supervision systems, through the model with output RS485 communication Modbus RTU, you can transmitted on the network main electrical parameters in addition to the energy consumption.

Functions

- Active and Reactive energy primary side (external CT and/or VT)
- Active energy to the terminals (MID)
- Current / Voltage
- Frequency
- Power factor
- Active, reactive and apparent power, phase active and reactive power, active power demand and active power max. demand
- Run hour meter (count start with currents >10mA or with the presence of the line voltages)

Cat. Nos.	Conto D4 - Pt MID	
	Network	Output
CE4DMID01	3Ph /3Ph + N	Pulse + RS485 ModBus RTU

Cat. Nos.	Accessories
	Description
AVKIT4	Wall mounting adapter (103x72mm)
AVKIT4Q	Wall mounting adapter (96x96mm)

Technical features

TECHNICAL NOTES	NT742
INPUT CURRENT	
Starting current (Ist)	0,01A
Min. current (Imin)	0,05A
Basic current (Ib)	5A
Max. current (Imax)	6A
Short-time overcurrent	30Imax/10ms
Power consumption	0,3W / 0,2VA for phase
INPUT VOLTAGE	
Reference three-phase voltage	100V-400V
Specified operating range	± 15%
NETWORK	
Reference frequency	50-60Hz
Frequency tolerance	49...51-59...61Hz
AUXILIARY SUPPLY	
Nominal voltage	230V
Tolerance	+ - 15%
Reference frequency	50Hz
Frequency tolerance	47...63Hz
Power consumption	4,5VA(2,2)W at 264V
ACCURACY	
Active energy kWh EN50470	cl. B
Reactive energy kvarh EN/IEC 62053-23	cl. 2
DISPLAY	
Type	Backlit LCD
Digit height	6mm
Energy resolution	depending on the CT/VT ratio**
MECHANICAL FEATURES	
Housing	4 module DIN 43880 (35mm)
Housing material	self-extinguishing polycarbonate
Protection degree	IP20 terminals/ IP51 front frame
Sealable terminals	Yes
Connections type	screw terminals
Cable with lag	output - max 4mm ² input - max 4mm ²
Flexible cable	output - max 2,5mm ² input - max 2,5mm ²
ENVIRONMENTAL CONDITIONS	
Nominal temperature range	-25...55°C
Limit range for storage and transport	-25...70°C
Suitable for tropical climates	yes
Max.power dissipation*	≤4W

*For switchboard thermal calculation

** kCT*kVT	MAXIMUM DISPLAY
1...9	999999,99kWh/kvarh
10...99	9999999,9kWh/kvarh
100...999	99999999kWh/kvarh
1000...9999	999999,99MWh/Mvarh
10000...99999	9999999,9MWh/Mvarh
100000...999999	99999999MWh/Mvarh

Wiring diagrams

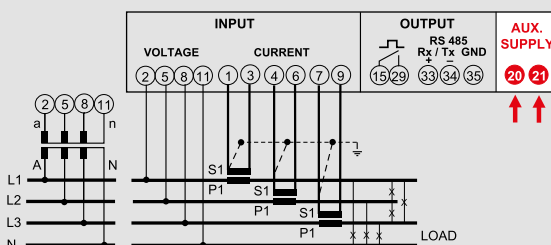
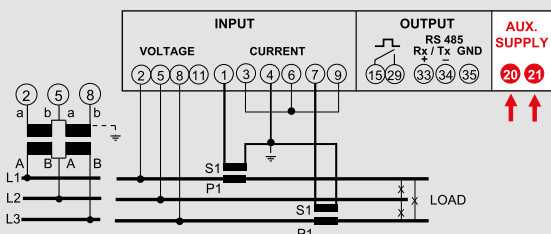

Output

ENERGY PULSES S0 EN/IEC 62053-31	
Type	Optorelay with potential-free
Contact range	27 Vdc/ac-50mA
Assignable energy	Active or reactive energy
Pulse weight	selectable 10Wh/varh...1MWh/Mvarh
Pulse duration	selectable 50...300ms

RS485 COMMUNICATION	
Protocol	MODBUS RTU
Standard	RS485-3-wire
Baud rate	selectable 4800...19200 bit/s

Static Energy Meters

Static meter 32 A direct connection



Direct connection for single-phase network. It makes available active energy counting of the pulse output to integration of consumption supervision systems.

Functions

- Active Energy

Cat. Nos.	Conto D1	Network	Output
CE11165A0		1Ph+N	-
CE11165A2		1Ph+N	Pulse

Technical features

TECHNICAL NOTES	NT784
INPUT CURRENT	
Starting current (Ist)	0,02A
Min. current (Imin)	0,5A
Basic current (Ib)	5A
Max. current (Imax)	32A
Short-time overcurrent	30Imax/10ms
Power consumption	9,7VA(0,5W) a 264V
INPUT VOLTAGE	
Reference single-phase voltage	230V
Specified operating range	196...264V
NETWORK	
Reference frequency	50-60Hz
Frequency tolerance	47...63Hz
AUXILIARY SUPPLY	
Nominal voltage	Taken from measurement (self-supplied)
ACCURACY	
Active energy kWh EN/IEC 62053-21	cl. 1
DISPLAY	
Type	LCD
Digit height	6mm
Energy resolution	99999,99 kWh
MECHANICAL FEATURES	
Housing	1 module DIN 43880 (35mm)
Housing material	self-extinguishing polycarbonate
Protection degree	IP20 terminals
Sealable terminals	Yes
Connections type	screw terminals
Cable with lag	output - max 6mm ² input - max 10mm ²
Flexible cable	output - max 4mm ² input - max 6mm ²
ENVIRONMENTAL CONDITIONS	
Nominal temperature range	-5...55°C
Limit range for storage and transport	-25...70°C
Suitable for tropical climates	yes
Max.power dissipation*	≤1W

*For switchboard thermal calculation

Output

ENERGY PULSES S0 EN/IEC 62053-31	
Type	Optorelay with potential-free
Contact range	12...27Vdc-10...27mA
Assignable energy	Active energy
Pulse weight	1 imp/Wh
Pulse duration	700ms

Wiring diagrams

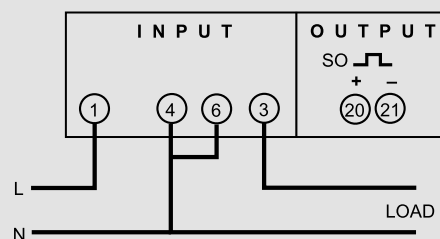

Static Energy Meters

Static meter 45 A direct connection



Direct connection for single-phase network.

For supervision systems, through the model with output RS485 communication Modbus RTU, you can transmitted on the network main electrical parameters in addition to the energy consumption.

Functions

- Active and Reactive energy
- Current / Voltage
- Power factor
- Active, reactive and apparent power

Cat. Nos.	Conto D1		
		Network	Output
CE11165A4		1Ph+N	RS485 ModBus RTU

Technical features

TECHNICAL NOTES	NT868
INPUT CURRENT	
Starting current (Ist)	0,02A
Min. current (Imin)	0,5A
Basic current (Ib)	5A
Max. current (Imax)	45A
Short-time overcurrent	30I _{max} /10ms
Power consumption	7,5VA / 0,6W
INPUT VOLTAGE	
Reference single-phase voltage	230V
Specified operating range	196...264V
NETWORK	
Reference frequency	50-60Hz
Frequency tolerance	47...63Hz
AUXILIARY SUPPLY	
Nominal voltage	Taken from measurement (self-supplied)
ACCURACY	
Active energy kWh EN/IEC 62053-21	cl. 1
DISPLAY	
Type	Backlit LCD
Digit height	6mm
Energy resolution	999999 kWh/kvarh
MECHANICAL FEATURES	
Housing	1 module DIN 43880 (35mm)
Housing material	self-extinguishing polycarbonate
Protection degree	IP20 terminals
Sealable terminals	Yes
Connections type	screw terminals
Cable with lag	output - max 6mm ² input - max 25mm ²
Flexible cable	output - max 4mm ² input - max 6mm ²
ENVIRONMENTAL CONDITIONS	
Nominal temperature range	-5...55°C
Limit range for storage and transport	-25...70°C
Suitable for tropical climates	yes
Max.power dissipation*	≤1W

*For switchboard thermal calculation

Output

RS485 COMMUNICATION	
Protocol	MODBUS RTU
Standard	RS485-3-wire
Baud rate	selectable 1200...9600 bit/s

Wiring diagrams

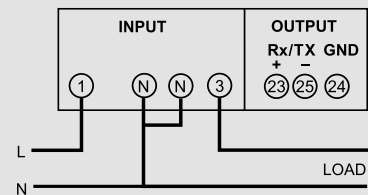

Static Energy Meters

Static meter 36 A direct connection



Direct connection for single-phase network.

Functions

- Active energy

Cat. Nos.	Conto D2-b	Network	Output
CE21175A0		1Ph+N	-

■ Technical features

TECHNICAL NOTES	NT660
INPUT CURRENT	
Starting current (Ist)	0,02A
Min. current (Imin)	0,25A
Basic current (Ib)	5A
Max. current (Imax)	36A
Short-time overcurrent	30Imax/10ms
Power consumption	9,7VA (1,3W) @ 264V
INPUT VOLTAGE	
Reference single-phase voltage	230-240V
Specified operating range	207...264V
NETWORK	
Reference frequency	50-60Hz
Frequency tolerance	47...63Hz
AUXILIARY SUPPLY	
Nominal voltage	Taken from measurement (self-supplied)
ACCURACY	
Active energy kWh EN/IEC 62053-21	cl. 1
DISPLAY	
Type	LCD
Digit height	6mm
Energy resolution	99999,9 kWh
MECHANICAL FEATURES	
Housing	2 module DIN 43880 (35mm)
Housing material	self-extinguishing polycarbonate
Protection degree	IP20 terminals/ IP51 front frame
Sealable terminals	Yes
Connections type	screw terminals
Cable with lag	input - max 16mm ²
Flexible cable	input - max 10mm ²
ENVIRONMENTAL CONDITIONS	
Nominal temperature range	-10...45°C
Limit range for storage and transport	-25...70°C
Suitable for tropical climates	yes
Max.power dissipation*	≤2,3W

*For switchboard thermal calculation

■ Wiring diagrams

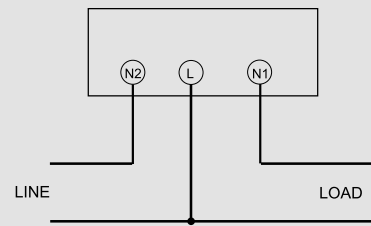

Static Energy Meters

Static meter 63 A direct connection



Direct connection for single-phase network.
 It makes available active energy counting of the pulse output to integration of consumption supervision systems.
 For supervision systems, through the model with output RS485 communication Modbus RTU, you can transmitted on the network main electrical parameters in addition to the energy consumption.

Functions

- Total active energy
- Partial active energy
- Current / Voltage
- Active power
- Frequency
- Power factor
- Run hour meter (count start with current >=20mA)

Cat. Nos.	Conto D2	
	Network	Output
CE20195A2	1Ph+N	Pulse
CE20195A4	1Ph+N	RS485 ModBus RTU

Technical features

TECHNICAL NOTES		NT765
INPUT CURRENT		
Starting current (Ist)		0,02A
Min. current (Imin)		0,25A
Basic current (Ib)		5A
Max. current (Imax)		63A
Short-time overcurrent		30Imax/10ms
Power consumption		4VA(1,9W) a 264V
INPUT VOLTAGE		
Reference single-phase voltage		230-240V
Specified operating range		196...264V
NETWORK		
Reference frequency		50Hz
Frequency tolerance		49...61Hz
AUXILIARY SUPPLY		
Nominal voltage		Taken from measurement (self-supplied)
ACCURACY		
Active energy kWh EN/IEC 62053-21		cl. 1
DISPLAY		
Type		LCD
Digit height		6mm
Energy resolution		99999,9 kWh/kvarh
MECHANICAL FEATURES		
Housing		2 module DIN 43880 (35mm)
Housing material		self-extinguishing polycarbonate
Protection degree		IP20 terminals/ IP51 front frame
Sealable terminals		Yes
Connections type		screw terminals
Cable with lag		output - max 4mm ² input - max 16mm ²
Flexible cable		output - max 2,5mm ² input - max 10mm ²
ENVIRONMENTAL CONDITIONS		
Nominal temperature range		-5...55°C
Limit range for storage and transport		-25...70°C
Suitable for tropical climates		yes
Max.power dissipation*		≤4W

*For switchboard thermal calculation

Output

ENERGY PULSES S0 EN/IEC 62053-31	
Type	Optorelay with potential-free
Contact range	27Vdc/ac – 50mA
Assignable energy	Active energy
Pulse weight	selectable 1Wh...1kWh
Pulse duration	selectable 50...500ms
RS485 COMMUNICATION	
Protocol	MODBUS RTU
Standard	RS485-3-wire
Baud rate	selectable 2400...19200 bit/s

Wiring diagrams

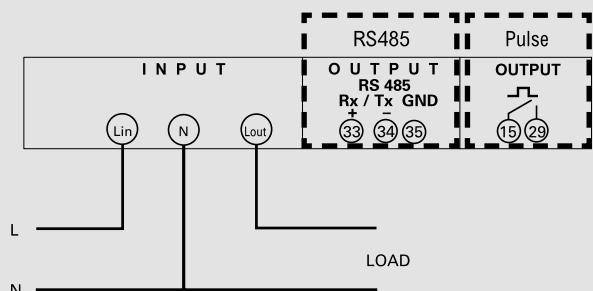

Static Energy Meters

Static meter 63 A direct connection



Direct connection for three-phase network, 3 or 4-wires and for single-phase 3 inputs.

It makes available active or reactive energy counting of the pulse output to integration of consumption supervision systems.

For supervision systems, through the model with output RS485 communication Modbus RTU or M-Bus, you can transmitted on the network main electrical parameters in addition to the energy consumption.

Functions

- Total active and reactive energy, active and reactive energy tariff 1 and tariff 2
- Partial active and reactive energy
- Active power max. demand, active power max. demand tariff 1 and tariff 2
- Partial active and reactive power
- Current / Voltage
- Frequency
- Power factor
- Active, reactive and apparent power,
- Run hour meter (count start: CE4DT36A4 0,4...50% rated power, CE4DT06A.. three-phase active power)

Cat. Nos.	Conto D4-Pd	Network	Output
CE4DT36A4		3x1Ph+N	RS485 ModBus RTU/TCP
CE4DT06A2		3Ph+N	Pulse
CE4DT06A4		3Ph+N	RS485 ModBus RTU/TCP
CE4DT06AM		3Ph+N	M-Bus
CE4DT06A23F		3Ph	Pulse output
CE4DT06A43F		3Ph	RS485 ModBus RTU/TCP

Technical features

CAT.NOS	CE4DT06A..	CE4DT36A4
TECHNICAL NOTES	NT669	NT880
INPUT CURRENT		
Starting current (Ist)	0,04A	
Min. current (Imin)	0,5A	
Basic current (Ib)	10A	
Max. current (Imax)	63A	
Short-time overcurrent	30Imax/10ms	
Power consumption	2VA (1,4W) 3-phase	
INPUT VOLTAGE		
Reference three-phase voltage	400-415V	-
Reference single-phase voltage	-	230-240V
Specified operating range	197...480V	190...264V
NETWORK		
Reference frequency	50-60Hz	
Frequency tolerance	47...63Hz	
AUXILIARY SUPPLY		
Nominal voltage	Taken from measurement (self-supplied)	
ACCURACY		
Active energy kWh EN/IEC 62053-21	cl. 1	
Reactive energy kvarh EN/IEC 62053-23	cl. 2	
DISPLAY		
Type	LCD	
Digit height	6mm	
Energy resolution	999999,99 kWh/kvarh	
MECHANICAL FEATURES		
Housing	4 module DIN 43880 (35mm)	
Housing material	self-extinguishing polycarbonate	
Protection degree	IP20 terminals/ IP52 front frame	
Sealable terminals	Yes	
Connections type	screw terminals	
Cable with lag	output - max 4mm ² input - max 16mm ²	
Flexible cable	output - max 2,5mm ² input - max 10mm ²	
ENVIRONMENTAL CONDITIONS		
Nominal temperature range	-5...55°C	
Limit range for storage and transport	-25...70°C	
Suitable for tropical climates	yes	
Max.power dissipation*	≤6W	

*For switchboard thermal calculation.

Wiring diagrams

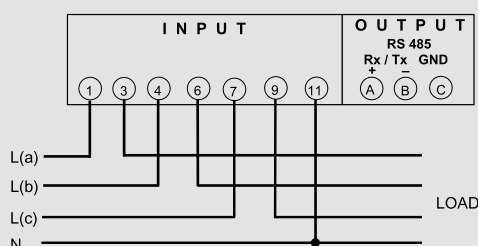
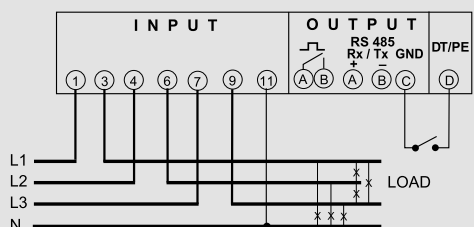

Output

ENERGY PULSES S0 EN/IEC 62053-31	
Type	Optorelay with potential-free
Contact range	27Vdc – 50mA
Assignable energy	Active or reactive energy
Pulse weight	selectable 1Wh/varh...10kWh/kvarh
Pulse duration	selectable 50...500ms
RS485 COMMUNICATION	
Protocol	MODBUS RTU/TCP
Standard	RS485-3-wire
Baud rate	selectable 4800...19200 bit/s
M-BUS COMMUNICATION	
Protocol	M-BUS
Standard	EN13757
Baud rate	selectable 300...9600 bit/s

Static Energy Meters

Static meter 125 A direct connection



Direct connection for three-phase network, 4-wires. It makes available active or reactive energy counting of the pulse output to integration of consumption supervision systems. For supervision systems, through the model with output RS485 communication Modbus RTU, you can transmitted on the network main electrical parameters in addition to the energy consumption.

Functions

- Total / Partial Active Energy or Active Energy Tariff 1 and 2
- Total / Partial Reactive Energy or reactive Energy Tariff 1 and 2
- Instantaneous Current
- Max. Demand and Instantaneous Power
- Voltage
- Frequency
- Power Factor
- Run hour meter (count start 0,4...50% rated power)

Cat. Nos.	Conto D6 Pd	
	Network	Output
CE6DT1252	3Ph + N	Pulse
CE6DT1256	3Ph + N	Pulse + RS485 ModBus RTU

Technical features

TECHNICAL NOTES	NT902
INPUT CURRENT	
Starting current (Ist)	0,04A
Min. current (Imin)	0,5A
Basic current (Ib)	10A
Max. current (Imax)	125A
Short-time overcurrent	30Imax/10ms
Power consumption	1,5W for phase
INPUT VOLTAGE	
Reference three-phase voltage	400V
Specified operating range	+/-15%
NETWORK	
Reference frequency	50-60Hz
Frequency tolerance	47...63Hz
AUXILIARY SUPPLY	
Nominal voltage	Taken from measurement (self-supplied)
ACCURACY	
Active energy kWh EN/IEC 62053-21	cl. 1
Reactive energy kvarh EN/IEC 62053-23	cl. 2
DISPLAY	
Type	Backlit LCD
Digit height	6mm
Energy resolution	999999,99 kWh/kvarh
MECHANICAL FEATURES	
Housing	6 module DIN 43880 (35mm)
Housing material	self-extinguishing polycarbonate
Protection degree	IP20 terminals/ IP54 front frame
Sealable terminals	Yes
Connections type	screw terminals
Cable with lag	output - max 1mm ² input - max 50mm ² (16 neutral)
Flexible cable	output - max 2,5mm ² input - max 35mm ² (16 neutral)
ENVIRONMENTAL CONDITIONS	
Nominal temperature range	-25...55°C
Limit range for storage and transport	-40...70°C
Suitable for tropical climates	yes
Max.power dissipation*	≤6W

*For switchboard thermal calculation

Output

ENERGY PULSES S0 EN/IEC 62053-31	
Type	Optorelay with potential-free
Contact range	27Vdc/ac – 50mA
Assignable energy	Active or reactive energy
Pulse weight	selectable 1Wh/varh...10kWh/kvarh
Pulse duration	selectable 50...500ms
RS485 COMMUNICATION	
Protocol	MODBUS RTU/TCP
Standard	RS485-3-wire
Baud rate	selectable 4800...19200 bit/s

Wiring diagrams

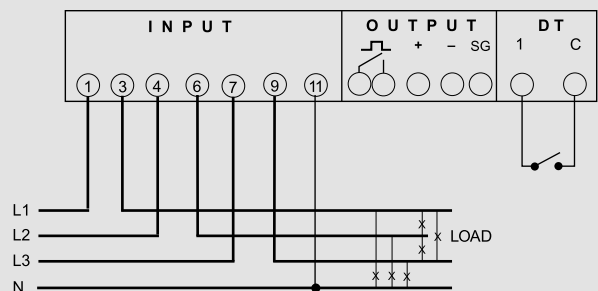

Static Energy Meters

Static meter by CT



Static meter by CT for single and three-phase network, 3 or 4-wires. It makes available active or reactive energy counting of the pulse output to integration of consumption supervision systems. For supervision systems, through the model with output RS485 communication Modbus RTU or M-Bus, you can transmitted on the network main electrical parameters in addition to the energy consumption.

Functions

- Total active and reactive energy
- Partial active and reactive energy
- Current / Voltage
- Frequency
- Power factor
- Active, reactive and apparent power, active power demand and active power max. demand
- Run hour meter (count start three-phase active power)

Cat. Nos.	Conto D4 Pt	
	Input (V)	Output
CE4DT12A2	100 -110	Pulse
CE4DT12A4	100 -110	RS485 ModBus RTU
CE4DT12A6	100 -110	Pulse + RS485 ModBus RTU
CE4DT12AM	100 -110	Pulse + M-Bus
CE4DT14A2	400 -415	Pulse
CE4DT14A4	400 -415	RS485 ModBus RTU
CE4DT14A6	400 -415	Pulse + RS485 ModBus RTU
CE4DT14AM	400 -415V	Pulse + M-Bus

Technical features

TECHNICAL NOTES	NT672
INPUT CURRENT	
Starting current (Ist)	0,02A
Min. current (Imin)	0,5A
Basic current (Ib)	1A + 5A
Max. current (Imax)	6A
Short-time overcurrent	20Imax/0,5s
Power consumption	4,5VA (1,85W) @ 440V 3-phase
INPUT VOLTAGE	
Reference three-phase voltage	400-415V and 100-115V
Reference single-phase voltage	230-240V and 100-115V
Specified operating range	210...264V and 90...140V
NETWORK	
Reference frequency	50Hz
Frequency tolerance	47...63Hz
AUXILIARY SUPPLY	
Nominal voltage	Taken from measurement (self-supplied)
ACCURACY	
Active energy kWh EN/IEC 62053-21	cl. 1
Reactive energy kvarh EN/IEC 62053-23	cl. 2
DISPLAY	
Type	LCD
Digit height	6mm
Energy resolution	depending on the CT ratio**
MECHANICAL FEATURES	
Housing	4 module DIN 43880 (35mm)
Housing material	self-extinguishing polycarbonate
Protection degree	IP20 terminals/ IP51 front frame
Sealable terminals	Yes
Connections type	screw terminals
Cable with lag	output - max 4mm ² input - max 4mm ²
Flexible cable	output - max 2,5mm ² input - max 2,5mm ²
ENVIRONMENTAL CONDITIONS	
Nominal temperature range	-5...55°C
Limit range for storage and transport	-25...70°C
Suitable for tropical climates	yes
Max.power dissipation*	≤2,8W

*For switchboard thermal calculation.

** kCT*kVT	MAXIMUM DISPLAY
1...9	999999,99kWh/kvarh
10...99	9999999,9kWh/kvarh
100...999	99999999kWh/kvarh
1000...9999	999999,99MWh/Mvarh
10000...99999	9999999,9MWh/Mvarh
100000...999999	99999999MWh/Mvarh

Output

ENERGY PULSES S0 EN/IEC 62053-31	
Type	Optorelay with potential-free
Contact range	27Vdc – 50mA
Assignable energy	Active or reactive energy
Pulse weight	selectable 1Wh/varh...10kWh/kvarh
Pulse duration	selectable 50...500ms
RS485 COMMUNICATION	
Protocol	MODBUS RTU
Standard	RS485-3-wire
Baud rate	selectable 4800...19200 bit/s
M-BUS COMMUNICATION	
Protocol	M-BUS
Standard	EN13757
Baud rate	selectable 300...9600 bit/s

Static Energy Meters

Static meter by CT

Wiring diagrams

Single-phase network,

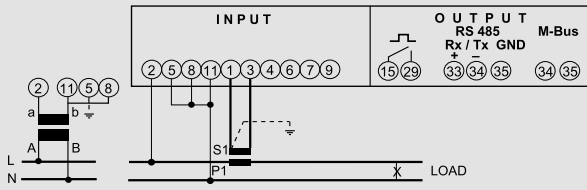

Three-phase 3Ph network, unbalanced load (aron L1-L2)

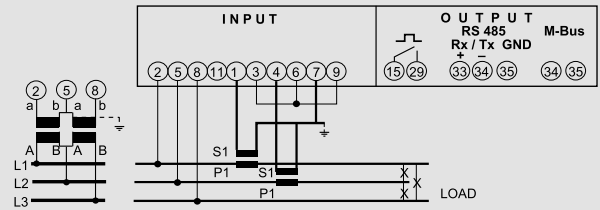

Three-phase 3Ph network, balanced load

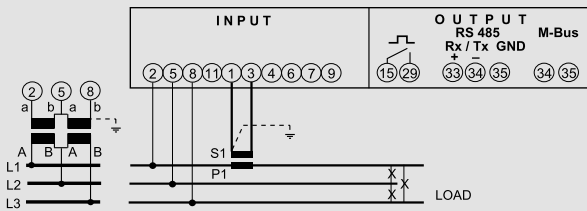

Three-phase 3Ph network, unbalanced load

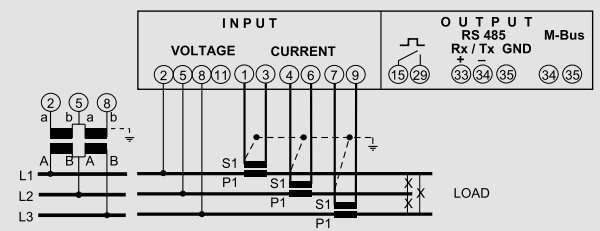

Three-phase 3Ph network, unbalanced load (aron L1-L3)

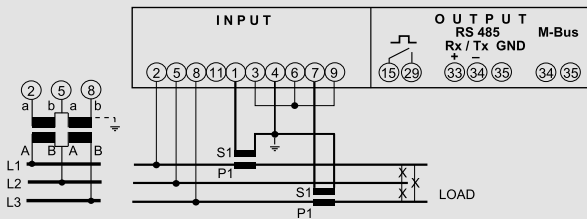

Three-phase 3P + N hnetwork, balanced load

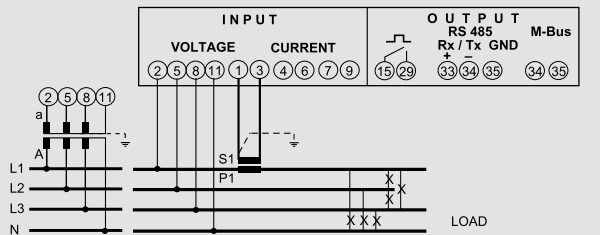

Three-phase 3Ph network, unbalanced load (aron L2-L3)

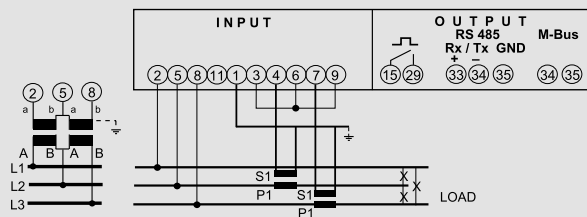

Three-phase 3P + N hnetwork, unbalanced load

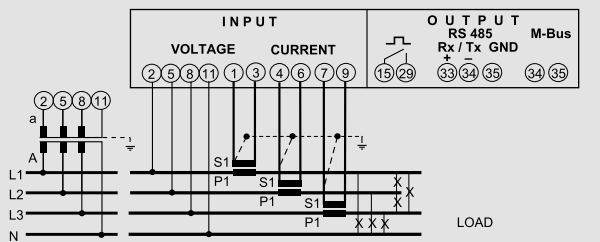

Static Energy Meters

Static meter by CT



Static meter by CT for single and three-phase network, 3 or 4-wires. It makes available active or reactive energy counting of the pulse output to integration of consumption supervision systems. For supervision systems, through the model with output RS485 communication Modbus RTU, you can transmitted on the network main electrical parameters in addition to the energy consumption.

Functions

- Total active and reactive energy
- Partial active and reactive energy
- Current / Voltage
- Frequency
- Power factor
- Active, reactive and apparent power, active power demand and active power max. demand

Cat. Nos.	Conto D4 Sh		Output
CE4ST14A2	Input (V)	400 -415	Pulse
CE4ST14A4		400 -415	RS485 ModBus RTU
CE4ST16A2		440	Pulse

Technical features

TECHNICAL NOTES		NT739
INPUT CURRENT		
Starting current (Ist)		0,01A
Min. current		0,5A
Basic current (Ib)		1A + 5A
Max. current (Imax)		6A
Short-time overcurrent		30Imax/0,5s
Power consumption		4,5VA (1,85W) @ 440V 3-phase
INPUT VOLTAGE		
Reference single-phase voltage		230-240V and 254V
Specified operating range		110...244V and 220...275V
Reference three-phase voltage		400-415V and 440V
Specified operating range		196...440V and 380...440V
NETWORK		
Reference frequency		50Hz
Frequency tolerance		47...63Hz
AUXILIARY SUPPLY		
Nominal voltage		Taken from measurement (self-supplied)
ACCURACY		
Active energy kWh EN/IEC 62053-21		cl. 1
Reactive energy kvarh EN/IEC 62053-23		cl. 2
DISPLAY		
Type		LCD
Digit height		6mm
Energy resolution		depending on the CT ratio**
MECHANICAL FEATURES		
Housing		4 module DIN 43880 (35mm)
Housing material		self-extinguishing polycarbonate
Protection degree		IP20 terminals/ IP54 front frame
Sealable terminals		Yes
Connections type		screw terminals
Cable with lag		output - max 4mm ² input - max 4mm ²
Flexible cable		output - max 2,5mm ² input - max 2,5mm ²
ENVIRONMENTAL CONDITIONS		
Nominal temperature range		-5...55°C
Limit range for storage and transport		-25...70°C
Suitable for tropical climates		yes
Max.power dissipation*		≤4W

*For switchboard thermal calculation

** kCT*kVT	MAXIMUM DISPLAY
1...9	999999,99kWh/kvarh
10...99	9999999,9kWh/kvarh
100...999	99999999kWh/kvarh
1000...9999	999999,99MWh/Mvarh

Output

ENERGY PULSES S0 EN/IEC 62053-31	
Type	Optorelay with potential-free
Contact range	110 Vcc/ca-50mA
Assignable energy	Active or reactive energy
Pulse weight	selectable 1Wh/varh...1MWh/Mvarh
Pulse duration	selectable 50...500ms
RS485 COMMUNICATION	
Protocol	MODBUS RTU
Standard	RS485-3-wire
Baud rate	selectable 4800...19200 bit/s

Static Energy Meters

Static meter by CT

Wiring diagrams

Single-phase network,

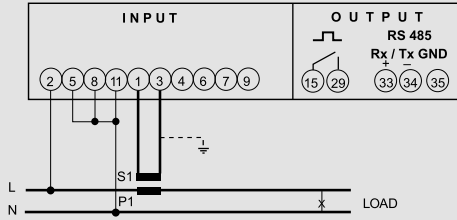

Three-phase 3Ph +N network, balanced load

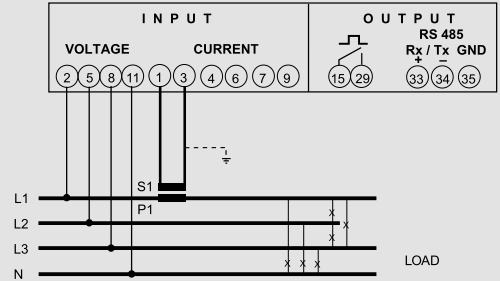

Three-phase 3Ph network, balanced load

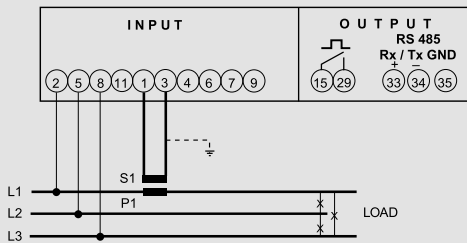

Three-phase 3Ph network, unbalanced load (aron L1-L2)

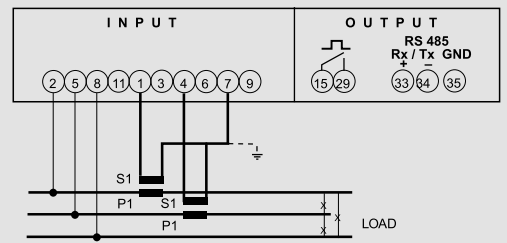

Three-phase 3Ph network, unbalanced load

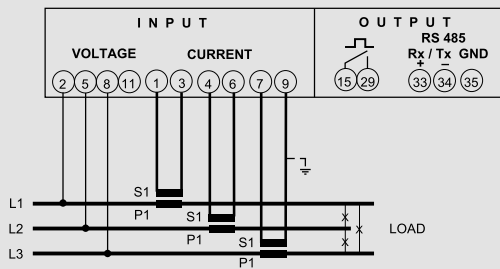

Three-phase 3Ph network, unbalanced load (aron L2-L3)

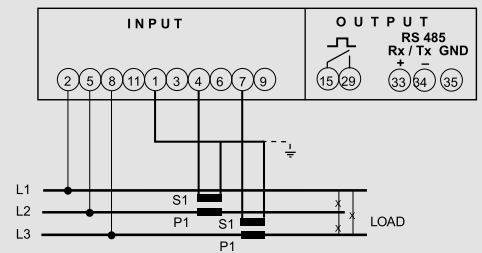

Three-phase 3Ph +N network, unbalanced load

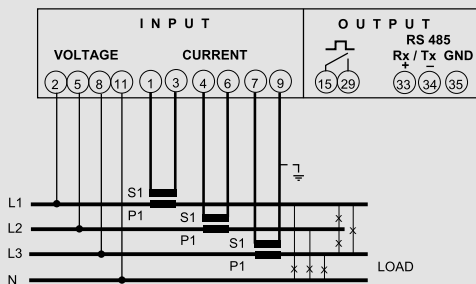

Three-phase 3Ph network, unbalanced load (aron L1-L3)

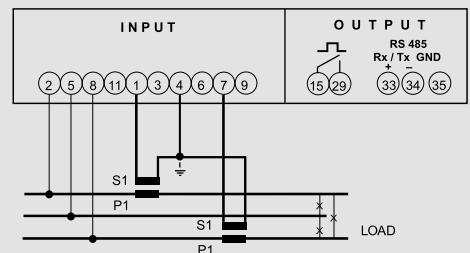

Static Energy Meters

Flush mounting static meter by CT



Static meter by CT for single and three-phase network, 3 or 4-wires. It makes available active or reactive energy counting of the pulse output to integration of consumption supervision systems.

For supervision systems, through the model with output RS485 communication Modbus RTU, you can transmitted on the network main electrical parameters in addition to the energy consumption.

Functions

- Total active and reactive energy
- Partial active and reactive energy
- Current / Voltage
- Frequency
- Power factor
- Active, reactive and apparent power, active power demand and active power max. demand

Cat. Nos.	Conto 72 Pt	
	Input (V)	Output
CE72T12A2	100 -110	Pulse
CE72T12A4	100 -110	RS485 ModBus RTU
CE72T14A2	400 -415	Pulse
CE72T14A4	400 -415	RS485 ModBus RTU

Cat. Nos.	Conto 96 Pt	
	Input (V)	Output
CE96T12A2	100 -110	Pulse
CE96T12A4	100 -110	RS485 ModBus RTU
CE96T14A2	400 -415	Pulse
CE96T14A4	400 -415	RS485 ModBus RTU

Technical features

MODEL	Conto 72 Pt	Conto 96 Pt
TECHNICAL NOTES	NT697	NT698
INPUT CURRENT		
Starting current (Ist)	0,02A	
Min. current (Imin)	0,5A	
Basic current (Ib)	1A + 5A	
Max. current (Imax)	6A	
Short-time overcurrent	30Imax/0,5s	
Power consumption	4,5VA (1,85W) @ 440V 3-phase	
INPUT VOLTAGE		
Reference three-phase voltage	400-415V and 100-115V	
Reference single-phase voltage	230-240V and 100-115V	
Specified operating range	210...264V and 90...140V	
NETWORK		
Reference frequency	50Hz	
Frequency tolerance	47...63Hz	
AUXILIARY SUPPLY		
Nominal voltage	Taken from measurement (self-supplied)	
ACCURACY		
Active energy kWh EN/IEC 62053-21	cl. 1	
Reactive energy kvarh EN/IEC 62053-23	cl. 2	
DISPLAY		
Type	LCD	
Digit height	6mm	
Energy resolution	depending on the CT ratio**	
MECHANICAL FEATURES		
Housing	flush mounting panel cutout (68X68)	flush mounting panel cutout (92X92)
Housing material	self-extinguishing polycarbonate	
Protection degree	IP20 terminals/ IP51 front frame	
Sealable terminals	Yes	
Connections type	screw terminals	
Cable with lag	output - max 4mm ² input - max 4mm ²	
Flexible cable	output - max 2,5mm ² input - max 2,5mm ²	
ENVIRONMENTAL CONDITIONS		
Nominal temperature range	-5...55°C	
Limit range for storage and transport	-25...70°C	
Suitable for tropical climates	yes	
Max.power dissipation*	≤2,8W	

*For switchboard thermal calculation

** kCT*kVT	MAXIMUM DISPLAY
1...9	999999,99kWh/kvarh
10...99	9999999,9kWh/kvarh
100...999	99999999kWh/kvarh
1000...9999	999999,99MWh/Mvarh
10000...99999	9999999,9MWh/Mvarh
100000...999999	99999999MWh/Mvarh

Output

ENERGY PULSES S0 EN/IEC 62053-31	
Type	Optorelay with potential-free
Contact range	110 Vcc/ca-50mA
Assignable energy	Active or reactive energy
Pulse weight	selectable 10Wh/varh...1MWh/Mvarh
Pulse duration	selectable 50...500ms
RS485 COMMUNICATION	
Protocol	MODBUS RTU
Standard	RS485-3-wire
Baud rate	selectable 4800...19200 bit/s

Static Energy Meters

Flush mounting static meter by CT

Dimensions

Conto 72 Pt

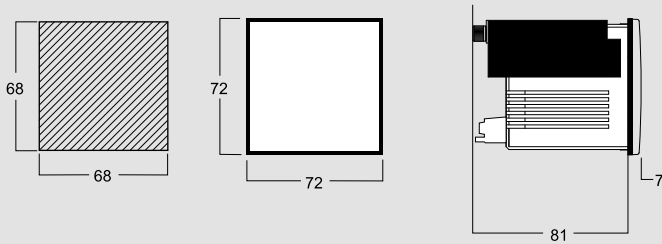

Conto 96- Pt

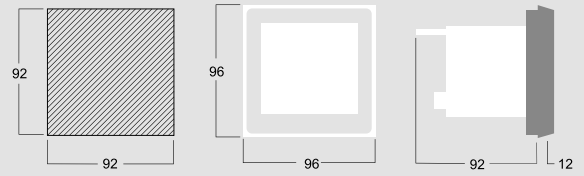

Wiring diagrams

Single-phase network,

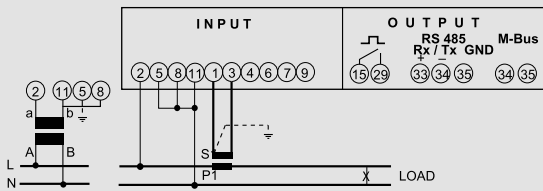

Three-phase 3Ph network, unbalanced load (aron L1-L2)

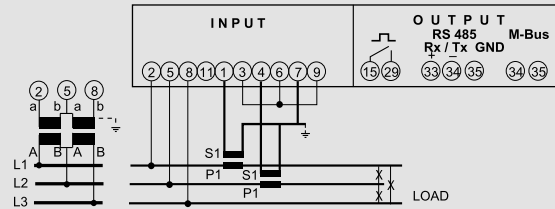

Three-phase 3Ph network, balanced load

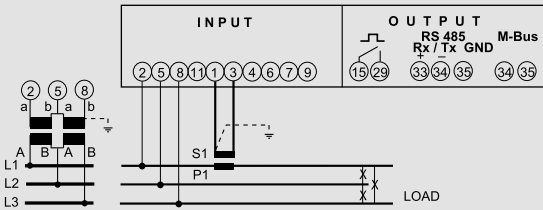

Three-phase 3Ph network, unbalanced load

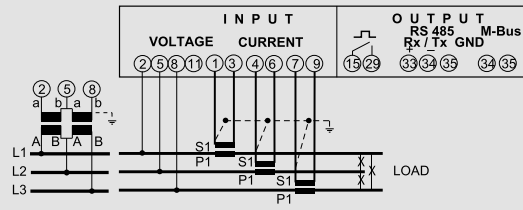

Three-phase 3Ph network, unbalanced load (aron L1-L3)

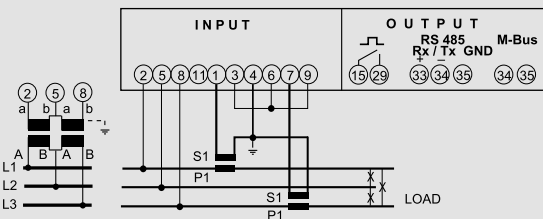

Three-phase 3Ph+N network, balanced load

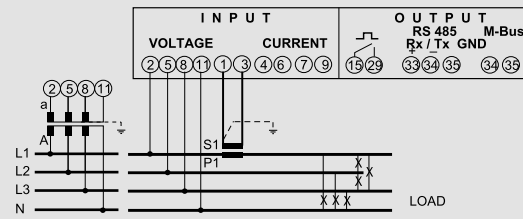

Three-phase 3Ph network, unbalanced load (aron L2-L3)

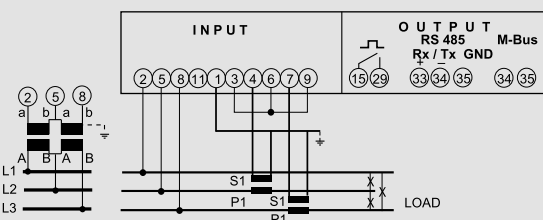

Three-phase 3Ph+N network, unbalanced load

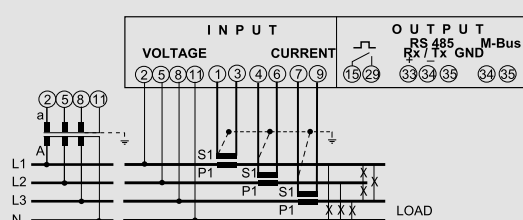

Static Energy Meters

Terminal blocks



Connection to 2- or 3-system 3-phase kWh-meters
 It allows to test or to replace the kWh- meters (by a standard meter), without disconnecting the current circuit
 Max. voltage 500V
 Max. current 57A
 Sealable protection cover

Cat. Nos.	AV Terminal blocks
	Description
AV201	3-phase Aron 2 CT connection, input/output rear connection cables (holes on insulating base)
AV202	3-phase + neutral 3 CT connection, input/output rear connection cables (holes on insulating base)
AV204	3-phase + neutral 3 CT connection, input /output front connection cables (holes on transparent cover)

Technical features

TECHNICAL NOTES	NT857
MECHANICAL FEATURES	
Housing	insulating base + sealable cover
Insulating base material	self-extinguishing Kelon (Ceramic + Nylon)
Sealable cover material	cellulose acetate
Sealable terminals	Yes
Weight	700 grams (AV201) - 1100 grams (AV202)
Connections type	screw terminals
Rigid cable	max 6mm ²
Flexible cable	max 6mm ²

Dimensions

AV201

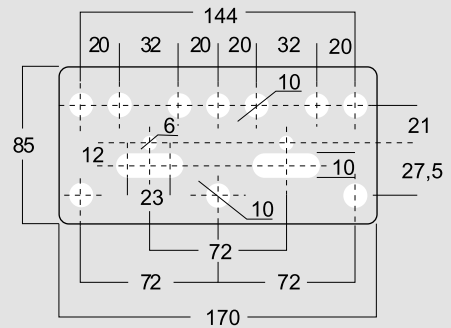

AV202 - AV204

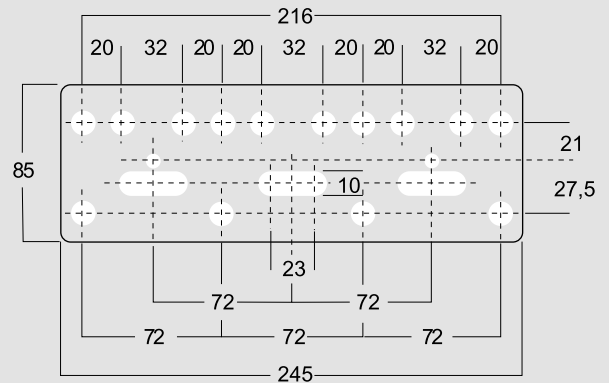

SOFTWARE AND INTERFACES



MIDAs Evo software

MIDAs Evo is the software that allows the centralized measurement acquisition, management and processing. Is available in 4 functional levels which differ for the number of devices they are able to manage (from 5 to 1020). For the most skilled users, the software offers the potentiality of a proper SCADA with advanced features to configure its own application in terms of interactive synoptics.

The program simply allows:

- Data acquisition via RS485/RS232 serial port and/or Ethernet up to 15 channels
- Instantaneous displays of parameters measured by devices (multifunction Nemo, energy meter Conto and pulse concentrators used for accounting of electricity or other sources)
- Analog or digital display
- Realization of graphic trends for one or more magnitudes with the opportunity to export in a tabular form
- Setting of software alarm thresholds to password-enabled users and e-mailing
- Display of active alarms
- Historical archive of events and alarms
- Monitoring of energy consumption for each device or for set creating one or more tariff calendars
- Web-server function to grant remote access to the central system where MIDAs Evo is installed using a simple Internet browser by specifying the IP address in the address bar

► Up to 1020 meters



All the instruments connected to the network are organized into sections:

- max. 17 meters for section
- max. 6 sections for page
- max. 60 sections

With a simple click on a single device, it is possible to control by virtual instruments all measured magnitudes.

► Graphic trends



It is possible to create graphs of one or more measured magnitudes in real time or relevant to a past time, simply by accessing the database, also observing the measured magnitudes in Excel compatible format file printable or exportable tables.

► Alarms



The enabled users can set software alarms on measurements returned from devices. Detected alarms and supervisor events (login, logout, communication errors) are stored into the database.

► Consumptions analyze



MIDAs Evo offers the possibility to analyze the consumptions applying for each type of energy up to 3 different tariff calendars. Data are stored without tariff indication, but with date and time only.

The creation of tariff calendars is very simple and straightforward; the user has a tool to simulate the consumption costs and decide the best tariff profile.

Monitoring systems

Thank to the management software and the interfaces range is possible to create more monitoring systems to allow local and/or remote management.

▶ LOCAL MONITORING RS 485 / Ethernet connection

PC whit MIDAs Evo, connected with the devices using both Ethernet port (through the network switch) and a Ethernet / RS485 interface, and COM port and USB/RS485 interface.

IFUSB01: USB / RS485 interface

IF4E011: RS485 / Ethernet interface

IF2E003: RS485 / RS485 repeater Over 31 devices or 1200 m. of line

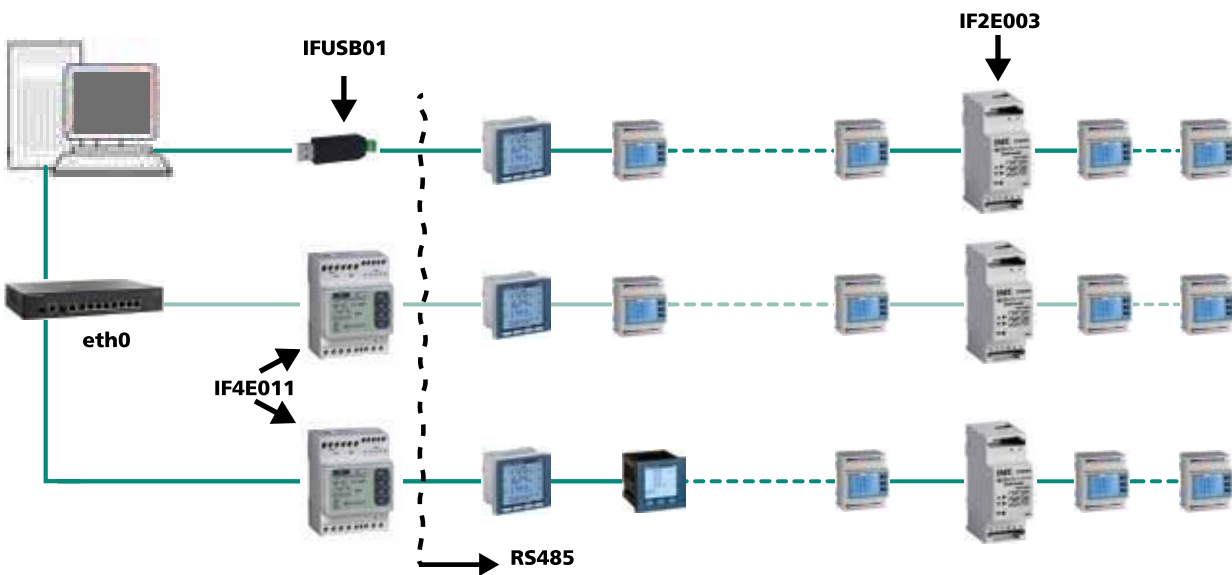

▶ REMOTE MONITORING Internet connection

PC whit MIDAs Evo, mounted in a network different from the one where the devices are. Query through network router where the system under monitoring is.

IF2E011: Ethernet / RS485 interface

IF2E003: RS485 / RS485 repeater Over 31 devices or 1200 m. of line

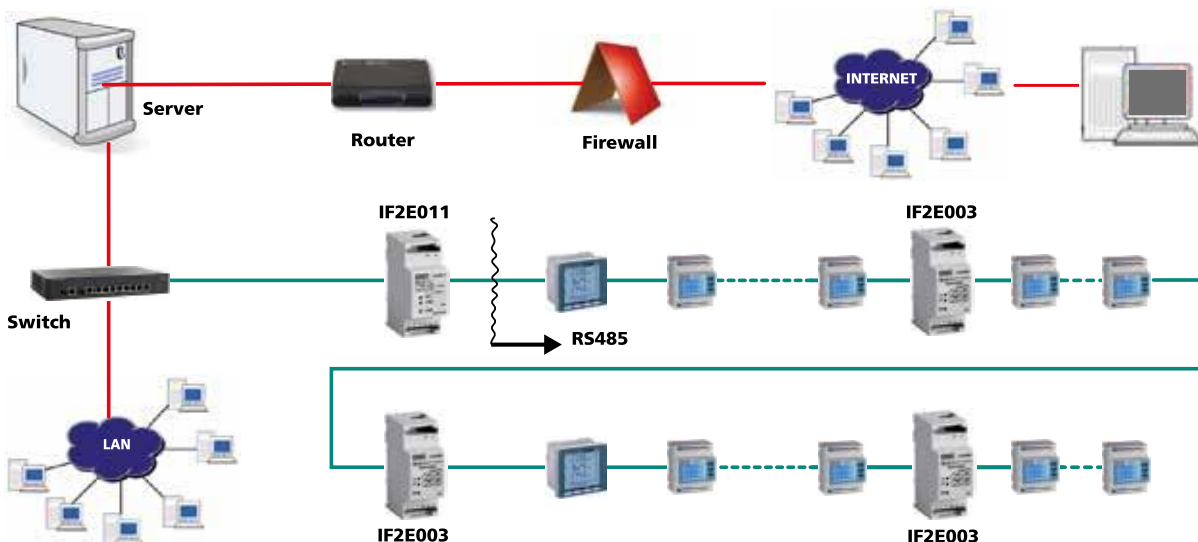

Software interfaces

Devices



IFUSB01



IF2E002



IF2E003



IF2E011



IF2ER01



IFMTR01



IF4E011



IF4C001



SWMF..

Cat. Nos.	Conversion interface USB-RS485
	it allows the direct connection to PC of Conto energy meters and Nemo multifunctions with RS485 output. It is exclusively suggested for local use. Useful to carry out programming on field and download the data from the memory module IF96012 combined with F.O.C. IDM Evolution software, downloadable from the website.
IFUSB01	USB-RS485

Cat. Nos.	Conversion interface RS232-RS485
	Direct connection on RS485 side up to 31 devices on a distance of 1200m at 9600 Baud or via repeaters up to 255.
IF2E002	80...270Vac+100...300Vdc
IF2E102	20...60Vdc+24Vac

Cat. Nos.	Repeater interface RS232-RS485
	It allows to amplify the signal to 31 other devices over a distance of 1200m included in the same RS485 line
IF2E003	80...270Vac+100...300Vdc
IF2E103	20...60Vdc+24Vac

Cat. Nos.	Conversion interface Ethernet-RS485
	It allows to interface Conto energy meters and Nemo multifunctions to an Ethernet 10/100MB network. Direct connection on RS485 line up to 31 devices or through repeaters up to 255. Two Bridge operating modes (Modbus RTU or Over TCP) or Web Server for the reading of main parameters and relevant download in csv format through a common internet browser. Direct access by IP interface
IF2E011	80...270Vac+100...300Vdc
IF2E111	20...60Vdc+24Vac

Cat. Nos.	Conversion interface RS485-radio 868MHz
	It allows data conversion of Nemo multifunctions and Conto energy meters on serial RS485 (direct connection up to 31) in a 868 MHz radio signal to be sent to the gateway transceiver IFMTR01
IF2ER01	9...30Vdc

Cat. Nos.	Gateway interface radio transceiver 868MHz-Ethernet
	It allows the conversion of the radio signals coming from the interfaces IF2ER01 and /or IF96018 making them available on the Ethernet output for connection to supervision systems. Adjustable stylus antenna with extension 20cm cable.
IFUSB01	Aux 9...30Vdc / 230Vac (Via power adapter provided in the box)

Cat. Nos.	Ethernet-RS485 Bridge or Datalogger function
	Multisession conversion interface (up to 4) Ethernet-RS485/ Datalogger, it allows to interface Conto energy meters and Nemo multifunctions to an Ethernet 10/100MB network. Direct connection on RS485 line up to 31 devices or through repeaters up to 255. Two Bridge operating modes (Modbus RTU or Over TCP) or Datalogger to store the energy data for each connected device and on demand to generate consumption reports for a selected period with the possibility to deliver by email to the system administrator. In this configuration, you can manage up to 64 different energy meters / multifunctions and users with individual access and a system administrator. Direct access by IP interface.
IF4E011	Aux 80...270Vac+100...300Vdc

Cat. Nos.	Pulse concentrator 12 inputs
	It allows to interface the Conto energy meters and all devices with pulse outputs (ex. water and gas meters) to data acquisition systems through RS485 Modbus-RTU output. Three possible configurations: 12 inputs from contact SPST-NO or 6 inputs from contact SPST-NO + 6 voltage contacts 27V max or 6 inputs from contact SPST-NO + inputs S0 (Wh+/Wh-/varh+/varh-/tariff change) for connection to ES card for GME (Enel measuring group)
IF4C001	Aux 230Vac

Cat. Nos.	MIDAs Evo Management software
	Management software for local monitoring networks and/or remote with Conto energy meters and Nemo multifunctions. It allows a real-time visualisation of data measured by the devices on field and the realisation of reports daily / monthly / yearly consumption divided by preselectable tariffs. Possibility to set software alarm thresholds by sending e-mail. Installation on PC with operating systems Windows XP Pro SP3 workstations, Windows 7 Pro 32 and 64bit, Windows 8 32 and 64bit, Windows 8.1 32 and 64bit.
SWMF2	licence up to 5 devices
SWMF3	licence up to 20 devices
SWMF4	licence up to 100 devices
SWMF5	licence up to 1020 devices

Software interfaces

Devices

Technical features

CAT.NOS.	IF2E002- IF2E102	IF2E003- IF2E103	IF2E011- IF2E111	IF4E011	IF4C001
TECHNICAL NOTES	NT693	NT694	NT809	NT891	NT783
COMMUNICATION					
Conversion:	RS485-RS232 or RS232-RS485	RS485-RS485	RS485-Ethernet	RS485-Ethernet	RS485-RS485
AUXILIARY SUPPLY					
Rated voltage:	80...270Vac + 100...300Vdc or 24Vac + 20...60Vdc			80...270Vac + 100...300Vdc	230V
Tolerance:	0,85...1,1Uaux				
Frequency:	50Hz				
Working frequency:	47...63Hz				
Rated burden:	≤ 4VA				≤ 5 VA
ELECTROMAGNETIC COMPATIBILITY					
Emission and immunity tests according to:	EN61326-1				
ENVIRONMENTAL CONDITIONS					
Nominal temperature range:	-5...55°C				
Limit range for storage and transport:	-25...70°C				
Suitable for tropical climates	yes				
Max. power dissipation * :	3,5W				3W
MECHANICAL FEATURES					
Housing:	2 modules DIN43880 (35mm)			4 modules DIN43880 (35mm)	
Connections:	screw terminals	Aux supply.: screw terminals RS485: screw terminals	Aux supply.: screw terminals RS485: plug-in connector Ethernet: RJ45 connector	screw terminals	
Housing material:	self-extinguishing polycarbonate				
Protection degree (EN60529):	IP50 (front frame) IP20 (terminals)				

* For switchboard thermal calculation

Wiring diagrams

IF2E002- IF2E102

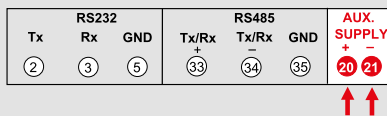

IF2E003- IF2E103

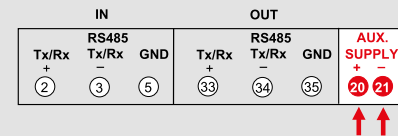

IF2E011- IF2E111

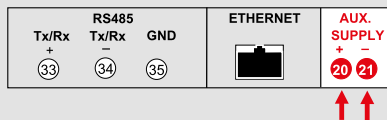

IF4E011

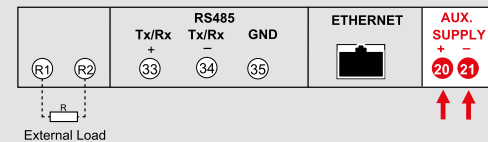

IF4C001

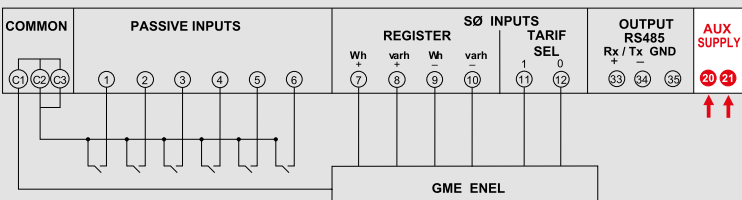
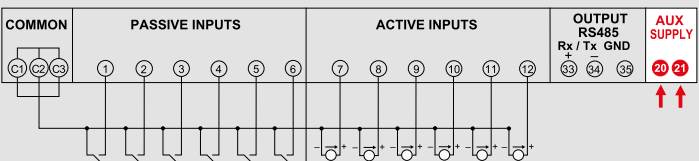
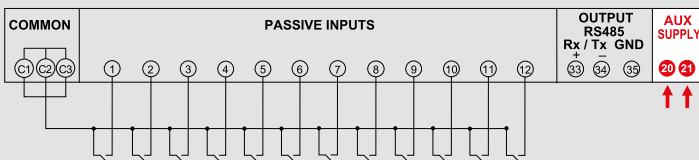

LOW VOLTAGE TRANSFORMERS



- Complete range of current **transformers**, 52 models from 1 A to 10 kA

GUIDE TO CHOOSE A CT

To choose the CT properly you need to know:

- System rated current
This is used to determine the transformer's primary current, e.g.:
System rated current: 425A = CT 500/5A
- Power bar/cable size
This makes it possible to choose a CT with a window that is large enough to pass the phase bar/ cord through, the tendency is always to choose a slightly bigger window so as to have a little play that is useful during installation, e.g.:
Cord of 120mm² (max. outer diam. 21.5mm) = I choose model TA327 with ø27mm hole.



**CT with cable/
passing bar
(Primary currents:
40...8000A)**



**CT with primary
winding
(Primary currents:
5...600A)**



**Open core CT
(Primary currents:
60...5000A)**

- Measurement class
Classes 0.5/1 recommended for measuring power, electricity and $\cos\phi$
Class 3 to be used for current measures on ammeters only
- Performance (VA)
This represents the maximum load that can be connected to the secondary terminals of the CT.
The load consists of the self consumption of the measurement instrument + adsorption of the cables connecting the CT and the instrument. This latter depends on the length and cross-section of the cable. For the functioning of a certain measurement class, the maximum load must always be lower or equal to the performance/ rated class of the CT.

The following is a table for calculating the absorption of the cables connecting the CT and the instrument.

Power absorbed (VA) by the cables connecting the CT and the instrument		
cross section mm ² copper	*VA per meter of bipolar cable at 20°C	
	secondary 5A	secondary 1A
1	1	0.04
1.5	0.685	0.0274
2.5	0.41	0.0164
4	0.254	0.0102
6	0.169	0.0068
10	0.0975	0.0039
16	0.062	0.0025

* The VA absorbed by the connection cables rises 4% for every 10% variation in the temperature.

CT/5A or CT/1A?

From the table shown above, it can be seen that using the same cross section the CT/1A absorbs 25 times less than the CT/5A because of the very long sections ($\geq 20m$). You are advised to choose a CT/1A so as to reduce the section and relative cost of the cables as well as ensuring more precise reading.

Current transformers for low voltage network - MEASURE

Selection table

PASSING CABLE/BUSBARS PRIMARY TRANSFORMERS																											
Model	TAIBB	TA221	TA327	TA426	TA432	TA540	TAC80	TAC110	TAS64	TAS81																	
Cat. Nos.	TABB...	TA221...	TA327...	TA426...	TA432...	TA540...	TA80...	TA11...	TASI...	TASN...																	
Technical notes	NT516	NT811	NT812	NT813	NT814	NT815	NT712	NT713	NT569	NT573																	
Width (mm)	44	49.5	56	60	70	70	125	165	90	100																	
Height (mm)	65	80	80	85	95	95	132	170	130	145																	
Cable (mm)	Ø21	Ø21	Ø27	Ø26	Ø32	Ø40	Ø80	Ø110																			
Window (mm)	16x12.5	20.5x10.5	25.5x15.5 32.5x10.5	32.5x15.5 40.5x12.5	25.5x25.5 32.5x20.5 40.5x10.5	40.5x20.5 50.5x12.5			51x31 64x11	64x31 81x11																	
Primary current	VA			VA			VA			VA			VA			VA			VA			VA			VA		
	cl 0.5	cl. 1	cl.3	cl 0.5	cl. 1	cl.3	cl 0.5	cl. 1	cl.3	cl 0.5	cl. 1	cl.3	cl 0.5	cl. 1	cl.3	cl 0.5	cl. 1	cl.3	cl 0.5	cl. 1	cl.3	cl 0.5	cl. 1	cl.3	cl 0.5	cl. 1	cl.3
40A			1						1.5																		
50A		1	1.5			2.5			2.5																		
60A		1	2		1.5	3			3																		
70A		1.5	2.5		1.5	4		1.5	3																		
75A		1.5	2.5		2	4		1.5	3.5																		
80A		1.5	2.5		3	4	1.5	2.5																			
100A	1.5	2.5	2.5	3	4		2	3				2	5														
120A	2	3.5	2.5	3	4		2	3.5				2	5														
125A	2	3.5	2.5	3	4		2	3.5				2	6														
150A	3	4		4	6		3	4		1.5	3	1	3														
160A	3	4		4	6		3	5		1.5	3	1.5	3														
200A	4	5.5		6	8		4	7		2.5	4	3	5			1.5	3										
250A	5	6		8	10		6	8		3	4	3	5			2	4						2.5				
300A	6	7.5		8	10		8	10		4	6	5	8		2	4	2.5	5					3				
400A							10	12		6	8	8	10		4	6	3	5	3	5			4			2	
500A							12	15		6	8	10	12		4	6	3	5	3	5	2	4	2	4	2	4	
600A							15	20		6	8	12	15		6	8	4	6	4	6	4	6	3	5			
700A										8	10	10	12		8	10						6	8	4	6		
750A										8	10	10	12		8	10						6	8	4	6		
800A										10	12	10	12		8	12	4	6	4	6	6	8	4	6			
1000A												12	15		10	12	6	8	8	10	8	10	6	8			
1200A															12	15			8	10	10	12	8	10			
1250A																						10	12	8	10		
1500A																						10	12	10	12		
1600A																			10	12	10	12	10	12			
2000A																								10	12		
2500A																								10	12		
3000A																											
3200A																											
4000A																											
5000A																											
6000A																											
8000A																											



(a)









(b)



TAS65	TAS84	TAS102	TAS102B	TAS127	TAS127B	TAU9	TAU10	TAU11	TAU12	TAU13							
(a) TASL... (b) TASL...3	(a) TASO... (b) TASO...3	(a) TAMP... (b) TAMP...3	(a) TAMQ... (b) TAMQ...3	(a) TASR... (b) TASR...3	(a) TASS... (b) TASS...3	TAUB...	TAUC...	TAUD...	TAUE...	TAUF...							
NT518	NT574	NT766	NT767	NT522	NT523	NT520	NT717	NT719	NT819	NT820							
90 (a) 94 (b)	96 (a) 116 (b)	98 (a) 129 (b)	135 (a) 129 (b)	99 (a) 160 (b)	125 (a) 160 (b)	177	257	257	177	257							
94 (a) 90 (b)	116 (a) 96 (b)	129 (a) 98 (b)	129 (a) 135 (b)	160 (a) 99 (b)	160 (a) 125 (b)	273.5	233.5	273.5	333.5	333.5							
32x65 (a) 65x32 (b)	34x84 (a) 84x34 (b)	38x102 (a) 102x38 (b)	54x102 (a) 102x54 (b)	38x127 (a) 127x38 (b)	54x127 (a) 127x54 (b)	55x165	120x125	120x165	55x225	120x225							
VA		VA		VA		VA		VA		VA		VA		VA		VA	
cl 0.5	cl. 1	cl 0.5	cl. 1	cl 0.5	cl. 1	cl 0.5	cl. 1	cl 0.5	cl. 1	cl 0.5	cl. 1	cl 0.5	cl 0.5	cl 0.5	cl 0.5	cl 0.5	cl 0.5
1	4																
1.5	6		2														
4	8	3	5					3	1	7							
8	10	5	7					2	4	3	10						
8	12	6	10					4	6	5	12						
10	12	6	10					4	8	8	15						
10	15	8	12					4	8	10	15						
12	15	8	12	8	10	10	12	4	8	10	15						
15	20	10	15	10	12	12	15	6	10	12	20						
15	20	12	15	12	15	15	20	8	12	15	25						
15	20	12	15	12	15	15	20	8	12	15	25						
20	25	15	20	12	15	20	25	10	15	20	30	20	20	20			
20	25	15	20	12	15	20	25	10	15	20	30						
20	25	20	25	20	25	20	25	15	20	25	30	30	30	30			
		25	30	20	25	25	30	20	25	30	50	40	40	40	40	40	40
				20	25	25	30	25	30	30	50	40	40	40	40	40	40
						25	30	25	30	30	50						
						30	40	25	30	30	50	50	50	50	50	50	50
												60	60	60	60	60	60
													70	70	70	70	70
														70	70	70	70

Current transformers for low voltage network - MEASURE

Selection table

WINDING PRIMARY TRANSFORMERS												
												
Model	TAQ2M	TAQ2L	TAQ6M	TAQ6L	TAQ10	TAQ20						
Cat. Nos.	TAQ2M..	TAQ2L...	TAQ6M...	TAQ6L...	TAQC...	TAQD...						
Technical notes	NT881	NT882	NT883	NT884	NT728	NT729						
Width (mm)	56	56	56	56	85	110						
Height (mm)	80	80	80	80	102.5	140						
Primary current	VA		VA		VA		VA		VA		VA	
	cl. 0.5	cl. 1	cl 0.5	cl. 1	cl 0.5	cl. 1	cl 0.5	cl. 1	cl 0.5	cl. 1	cl 0.5	cl. 1
5A	2	4			6	7.5			10	15	20	40
10A	2	4			6	7.5			10	15	20	40
15A	2	4			6	7.5			10	15	20	40
20A	2	4			6	7.5			10	15	20	40
25A	2	4			6	7.5			10	15	20	40
30A	2	4			6	7.5			10	15	20	40
40A	2	4			6	7.5			10	15	20	40
50A			2	4			6	7.5	10	15	20	40
60A			2	4			6	7.5	10	15	20	40
70A									10	15	20	40
75A			2	4			6	7.5	10	15	20	40
80A			2	4			6	7.5	10	15	20	40
100A			2	4					10	15	20	40
120A									10	15	20	40
125A									10	15	20	40
150A									10	15	20	40
160A									10	15	20	40
200A									10	15	20	40
250A											20	40
300A											20	40
400A											20	40
500A											20	40
600A											20	40

OPEN-CORE TRANSFORMERS

Model	TRA11	TRA15	TRA230	TRA580	TRA812	TRA816										
Cat. Nos.	TAAA..	TAAB...	TA230...	TA580...	TA812...	TA816...										
Technical notes	NT721	NT722	NT869	NT841	NT842	NT818										
Width (mm)	235	275	92	120	150	184										
Height (mm)	219	259	110	150	190	245										
Cable (mm)	Ø110	Ø150														
Window (mm)			20x30	50.5x80.5	80.5x120.5	80x160										
Primary current	VA			VA			VA			VA			VA			
	cl 0.5	cl. 1	cl. 3	cl 0.5	cl. 1	cl. 3	cl 0.5	cl. 1	cl. 3	cl 0.5	cl. 1	cl 0.5	cl. 1	cl. 3	cl 0.5	cl. 1
60A									1							
100A			3			3			1.5							
120A			3			3										
150A			5			5	1.5	2.5								
200A			5			5	1	2.5								
250A		5			5		1.5	3		1	2					
300A		5			5		1.5	4		1.5	3					
400A	5			5			2.5	6		1.5	3					
500A	8			8						2.5	5		4	12		
600A	15			15						2.5	5		5	14		
800A	15			15						3	7	3	7			
1000A	15			15						5	10	5	10			
1200A	20			20								6	11			
1500A	20			20								8	15			
2000A	25			25											15	20
2500A				25											15	20
3000A				25											20	25
4000A				30											20	25
5000A				30											20	25

CURRENT SUMMATION TRANSFORMERS

Model	BSA02	BSA03	BTA2		
Cat. Nos.	TAEA...	TAEA...	TAEB...		
Technical notes	NT731	NT731	NT732		
Width (mm)	70	70	121		
Height (mm)	93	93	124		
Primary current	VA		VA		VA
	cl 0.5	cl. 1	cl 0.5	cl. 1	cl 0.5
5+5A	10	15			40
5+5+5A			10	15	40
5+5+5+5A					40
5+5+5+5+5A					15
5+5+5+5+5+5A					15
1+1A	10	15			40
1+1+1A			10	15	40
1+1+1+1A					40
1+1+1+1+1A					15
1+1+1+1+1+1A					15

Current transformers for low voltage network - PROTECTION

Selection table

PASSING CABLE/BUSBARS PRIMARY TRANSFORMERS																											
Model	TAS63P	TAS80	TAS80P	TAS102BP		TAS125	TAS125P	TAU81P	TAU91P																		
Cat. Nos.	TAWA...	TASM...	TAWB...	(a) TAPQ... (b) TAPQ...3		TASQ...	TAWC...	TAXA...	TAXB...																		
Technical notes	NT645	NT571	NT572	NT768		NT575	NT576	NT715	NT716																		
Width (mm)	100	124	124	135 (a) 129 (b)		182	182	177	257																		
Height (mm)	117.5	136	136	129 (a) 135 (b)		193	193	233.5	273.5																		
Window (mm)	41x21 51x20 64x19	82x32	82x32	54x102 (a) 102x54 (b)		127x54	127x54	55x125	55x165																		
Primary current	VA		VA		VA				VA		VA		VA				VA				VA						
	cl. 5P5	cl. 5P10	cl. 5P5	cl. 5P10	cl. 5P5	cl. 5P10	cl. 5P15	cl. 5P20	cl. 5P5	cl. 5P10	cl. 5P5	cl. 5P10	cl. 5P5	cl. 5P10	cl. 5P15	cl. 5P20	cl. 5P5	cl. 5P10	cl. 5P15	cl. 5P20	cl. 5P5	cl. 5P10	cl. 5P15	cl. 5P20	cl. 5P5	cl. 5P10	cl. 5P15
250A	2.5	1																									
300A	3.5	1.2	6	2.5	8	4	2.5	1.5																			
400A	4	1.5	7	2.5	10	5	3	2			6	3	12	6	3.5	2.5											
500A	5	1.5	10	3	12	6	4	2.5			10	3	15	7	4	3											
600A	6	2	10	4	15	7	4.5	3			10	5	20	10	5	4											
700A	7	2	10	4	16	8	4.5	3			10	5	20	10	6	4											
750A	7	2	10	4	20	9	5	3			10	5	25	10	7	5											
800A	7	1.5	10	4	20	8	4.5	2.5	10	4	15	5	25	10	7	5											
1000A	7	1.5	15	4	25	10	6	3	12	5	15	5	30	15	8	6											
1200A	10	1.5	20	5	30	12	6	3	12	5	20	5	35	15	8	6											
1250A	10	2	20	5	30	12	6	3	12	5	20	5	35	15	8	6											
1500A	10	1.5	25	5	35	12	5		15	6	20	5	40	20	10	6	50	15	6	1.5	50	15	6	2			
1600A	10	1.5	25	5	35	12	5		15	6	20	5	40	20	10	6											
2000A			30	6	40	12	3		20	6	25	5	50	20	10	4	50	15	6	1.5	50	20	10	3			
2500A			35	6	45	10			20	6	30	5	60	20	10	3	80	25	10	1.5	80	25	10	3			
3000A									20	4	40	5	80	25	10	3	80	35	15	4	80	35	15	4			
4000A											50	5	100	30	15	3	100	35	10		100	40	15	5			
5000A																					100	40	20	5			
6000A																											
8000A																											

TAU101P				TAU111P				TAU121P				TAU131P			
TAXC...				TAXD...				TAXE...				TAXF...			
NT718				NT720				NT821				NT822			
257				257				177				257			
233.5				273.5				333.5				333.5			
120x125				120x165				55x225				120x225			
VA				VA				VA				VA			
cl. 5P5	cl. 5P10	cl. 5P15	cl. 5P20	cl. 5P5	cl. 5P10	cl. 5P15	cl. 5P20	cl. 5P5	cl. 5P10	cl. 5P15	cl. 5P20	cl. 5P5	cl. 5P10	cl. 5P15	cl. 5P20
50	15	6	1.5	50	15	6	2								
50	15	6	1.5	50	20	10	3								
80	25	10	1.5	80	25	10	3	25	20	10	5	25	20	10	5
100	35	10		80	35	15	4	30	25	15	7.5	30	25	15	7.5
100	40	15		100	40	15	5	40	35	20	10	40	35	20	10
160	40	8		100	40	20	5	50	40	25	10	50	40	25	10
180	50	10		100	40	20	3	60	50	30	12.5	60	50	30	12.5
				100	40	20						70	70	40	15

WINDING PRIMARY TRANSFORMERS

Model	TAQ10P	TAQ20P		
Cat. Nos.	TAVB...	TAVA...		
Technical notes	NT823	NT730		
Width (mm)	85	110		
Height (mm)	102.5	140		
Primary current	VA		VA	
	cl 5P5	cl. 5P10	cl 5P5	cl. 5P10
5A	4	2	8	4
10A	4	2	8	4
15A	4	2	8	4
20A	4	2	8	4
25A	4	2	8	4
30A	4	2	8	4
40A	4	2	8	4
50A	4	2	8	4
60A	4	2	8	4
70A	4	2	8	4
75A	4	2	8	4
80A	4	2	8	4
100A	4	2	8	4
120A	4	2	8	4
150A	4	1,5	8	4
200A	4	2	8	4
250A	4	2	8	4
300A	4	2	8	4
400A			8	4
500A			8	4
600A			8	4

Current transformers for low voltage network - ACCURACY

Selection table

PASSING CABLE/BUSBARS PRIMARY TRANSFORMERS																					
Model	TA327	TA432	TAS65		TAS84		TAS102		TAS127		TAS127B										
Cat. Nos.	TA327...S	TA432...S	(a) TASL...S (b) TASL...3S		(a) TASO...S (b) TASO...3S		(a) TAMP...S (b) TAMP...3S		(a) TASR...S (b) TASR...3S		(a) TASS...S (b) TASS...3S										
Technical notes	NT829	NT830	NT831		NT832		NT833		NT834		NT835										
Width (mm)	56	70	90 (a) 94 (b)		96 (a) 116 (b)		98 (a) 129 (b)		99 (a) 160 (b)		125 (a) 160 (b)										
Height (mm)	80	90	94 (a) 90 (b)		116 (a) 96 (b)		129 (a) 98 (b)		160 (a) 99 (b)		160 (a) 125 (b)										
Cable (mm)	Ø27	Ø32																			
Window (mm)	25.5x15.5 32.5x10.5	25.5x25.5 32.5x20.5 40.5x10.5	32x65 (a) 65x32 (b)		34x84 (a) 84x34 (b)		38x102 (a) 102x38 (b)		38x127 (a) 127x38 (b)		54x127 (a) 127x54 (b)										
Primary current	VA			VA			VA			VA			VA			VA					
	cl. 0.2s	cl. 0.5s	cl. 0.2s	cl. 0.5s	cl. 0.2s	cl. 0.5s	cl. 0.2s	cl. 0.5s	cl. 0.2s	cl. 0.5s	cl. 0.2s	cl. 0.5s	cl. 0.2s	cl. 0.5s	cl. 0.2s	cl. 0.5s	cl. 0.2s	cl. 0.5s			
150A	1	1.5	2																		
160A	1	1.5	2																		
200A	2	2.5	3	1	1.5	2,5															
250A	2	2.5	3	1	1.5	2,5															
300A	2.5	4	5	1.5	2	3															
400A	4	5	8	1.5	3	4															
500A	6	7	10	2.5	5	5															
600A	8	10	15	3	6	7	1	3	5												
700A				4	7	7	1,5	4	7,5												
750A				4	7	8	2	5	7,5												
800A				5	8	10	2,5	7,5	10	4	6	7									
1000A				6	10	12	10	12	15	6	7	8	5	7,5	10	4	6	8			
1200A							12	15	20	10	12	14	5	7,5	10	5	7,5	10			
1250A							12	15	20	10	12	14	5	7,5	10	5	7,5	10			
1500A							12	15	20	15	17,5	20	7,5	10	15	7,5	10	12,5	7,5	10	12,5
1600A							12	15	20	15	17,5	20	7,5	10	15	7,5	10	12,5	7,5	10	12,5
2000A							12	15	20	15	20	25	10	15	20	10	15	20	10	12,5	15
2500A													15	20	25	15	20	25	12,5	15	20
3000A													20	25	30	20	25	30	15	20	25
3200A																			15	20	25
4000A																			20	25	30

WINDING PRIMARY TRANSFORMERS						
Model	TAQ6M	TAQ6L	TAQ10			
Cat. Nos.	TAQ6M...S	TAQ6L...S	TAQC...S			
Technical notes	NT885	NT886	NT826			
Type	Winding primary	Winding primary	Winding primary			
Width (mm)	56	56	85			
Height (mm)	50	80	102.5			
Primary current	VA		VA		VA	
	cl. 0.2	cl. 0.5s	cl. 0.2	cl. 0.5s	cl. 0.2	cl. 0.5s
5A	3	5			5	10
10A	3	5			5	10
15A	3	5			5	10
20A	3	5			5	10
25A	3	5			5	10
30A	3	5			5	10
40A	3	5			5	10
50A			3	5	5	10
60A			3	5	5	10
70A					5	10
75A			3	5	5	10
80A			3	5	5	10
100A					5	10
120A					5	10
125A					5	10
150A					5	10

Voltage transformers for low voltage network

Selection table

VOLTAGE TRANSFORMERS - MEASURE/PROTECTION																	VOLTAGE TRANSFORMERS - ACCURACY					
Model	BTV3		BTV6		BTV10			BTV20			BTV50			BTV100			Model	BTV6	BTV10	BTV20	BTV50	BTV100
Cat. Nos.	TVVA...		TVVB...		TVVC...			TVVD...			TVVE...			TVVF...			Cat. Nos.	TVVB...	TVVC...	TVVD...	TVVE...	TVVF...
Technical notes	NT733		NT734		NT735			NT736			NT737			NT738			Technical notes	NT836	NT837	NT838	NT839	NT840
Width (mm)	80		120		125			140			165			180			Width (mm)	120	125	140	165	180
Height (mm)	115		100		100			100			125			125			Height (mm)	100	100	100	125	125
Depth (mm)	96		85		85			85			103			103			Depth (mm)	85	85	85	103	103
Primary voltage	VA		VA		VA			VA			VA			VA			Primary voltage	VA	VA	VA	VA	VA
	cl. 1	cl. 0.5	cl. 1	cl. 3P	cl. 0.5	cl. 1	cl. 3P	cl. 0.5	cl. 1	cl. 3P	cl. 0.5	cl. 1	cl. 3P	cl. 0.5	cl. 1	cl. 3P		cl. 0.2	cl. 0.2	cl. 0.2	cl. 0.2	cl. 0.2
100V	6	6	9	20	10	15	30	20	30	50	50	75	100	100	150	200	230V	2.5	4	8	20	40
110V	6	6	9	20	10	15	30	20	30	50	50	75	100	100	150	200	240V	2.5	4	8	20	40
115V	6	6	9	20	10	15	30	20	30	50	50	75	100	100	150	200	400V	2.5	4	8	20	40
230V	6	6	9	20	10	15	30	20	30	50	50	75	100	100	150	200	440V	2.5	4	8	20	40
240V	6	6	9	20	10	15	30	20	30	50	50	75	100	100	150	200	450V	2.5	4	8	20	40
400V	6	6	9	20	10	15	30	20	30	50	50	75	100	100	150	200	500V	2.5	4	8	20	40
440V	6	6	9	20	10	15	30	20	30	50	50	75	100	100	150	200	600V	2.5	4	8	20	40
450V	6	6	9	20	10	15	30	20	30	50	50	75	100	100	150	200	660V	2.5	4	8	20	40
500V	6	6	9	20	10	15	30	20	30	50	50	75	100	100	150	200	690V	2.5	4	8	20	40
600V	6	6	9	20	10	15	30	20	30	50	50	75	100	100	150	200	700V			8	20	40
660V	6	6	9	20	10	15	30	20	30	50	50	75	100	100	150	200	800V			8	20	40
690V	6	6	9	20	10	15	30	20	30	50	50	75	100	100	150	200	1000V			8	20	40
700V								20	30	50	50	75	100	100	150	200						
800V								20	30	50	50	75	100	100	150	200						
1000V								20	30	50	50	75	100	100	150	200						
3-PHASE primary voltage	VA		VA		VA			VA			VA			VA			Primary voltage	VA	VA	VA	VA	VA
	cl. 1	cl. 0.5	cl. 1	cl. 3P	cl. 0.5	cl. 1	cl. 3P	cl. 0.5	cl. 1	cl. 3P	cl. 0.5	cl. 1	cl. 3P	cl. 0.5	cl. 1	cl. 3P		cl.0.2	cl.0.2	cl.0.2	cl.0.2	cl.0.2
	3	3	4	10	5	7	15	8	10	25	25	30	50	50	75	100	230-1000V - √3	1	2	3	8	14

Current transformers - MEASURE

Open core single-phase current transformer



TRA11



TRA15

Cat. Nos. **TRA11**

Passing cable window/bar Ø 110mm

Isr 5A	Primary current (A)	Accuracy class VA		
		cl. 0.5	cl. 1	cl. 3
TAAA50C100	100A	-	-	3
TAAA50C120	120A	-	-	3
TAAA50C150	150A	-	-	5
TAAA50C200	200A	-	-	5
TAAA50C250	250A	-	5	-
TAAA50C300	300A	-	5	-
TAAA50C400	400A	5	-	-
TAAA50C500	500A	8	-	-
TAAA50C600	600A	15	-	-
TAAA50C800	800A	15	-	-
TAAA50D100	1000A	15	-	-
TAAA50D120	1200A	20	-	-
TAAA50D150	1500A	20	-	-
TAAA50D200	2000A	25	-	-

Cat. Nos. **TRA15**

Passing cable window/bar Ø 150mm

Isr 5A	Primary current (A)	Accuracy class VA		
		cl. 0.5	cl. 1	cl. 3
TAAB50C100	100A	-	-	3
TAAB50C120	120A	-	-	3
TAAB50C150	150A	-	-	5
TAAB50C200	200A	-	-	5
TAAB50C250	250A	-	5	-
TAAB50C300	300A	-	5	-
TAAB50C400	400A	5	-	-
TAAB50C500	500A	8	-	-
TAAB50C600	600A	15	-	-
TAAB50C800	800A	15	-	-
TAAB50D100	1000A	15	-	-
TAAB50D120	1200A	20	-	-
TAAB50D150	1500A	20	-	-
TAAB50D200	2000A	25	-	-
TAAB50D250	2500A	25	-	-
TAAB50D300	3000A	25	-	-
TAAB50D400	4000A	30	-	-
TAAB50D500	5000A	30	-	-

Technical features

MODEL	TRA11	TRA15
TECHNICAL NOTES	NT721	NT722
SPECIFICATIONS		
Reference specification	EN/IEC 61869-1, 61869-2	
Rated primary current I _{pr} :	100...2000A	100...5000A
Rated frequency:	50Hz	
Working frequency:	47...63Hz	
Rated continuous thermal current I _{cth} :	100% I _{pr}	
Rated short-time thermal current I _{th} :	< 60I _{pr} (max.90kA/1s)	
Rated dynamic current I _{dyn} :	2,5I _{th}	
Instrument security factor (FS):	≤ 15	
Rated secondary current I _{sr} :	5A	
Max. power dissipation	≤ 25W	≤ 25W
Allowed max cable or busbar temperature:	125°C	
INSULATION REQUIREMENTS		
Type	Dry transformer, air insulation	
Highest voltage for equipment U _m :	0.72kV r.m.s.	
Rated insulation level:	3kV r.m.s. 50Hz/1min	
Class of insulation (EN/IEC 61869-1, 61869-2):	B	
ENVIRONMENTAL CONDITIONS		
Nominal temperature range:	-25...50°C	
Limit temperature range for storage:	-40...85°C	
Relative humidity:	≤ 85%	
Suitable for tropical climates	yes	
CONNECTION		
Primary winding:	passing bus bar	
Secondary winding	tightening by nut M4	
MECHANICAL FEATURES		
Housing material:	self extinguishing polycarbonate	
Protection degree (EN/IEC 60529):	IP20 with sealable terminal cover IP20 housing	
Weight:	4200 gr	5500 gr

Wiring diagrams

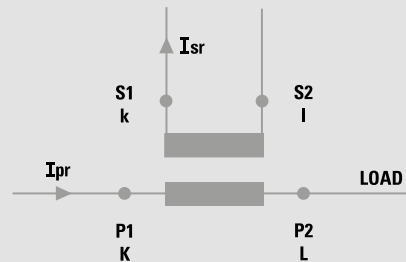

Dimensions

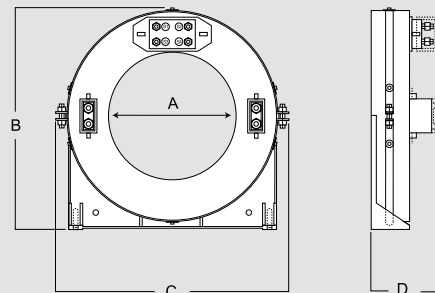

Dim. (mm)	A	B	C	D
TRA11	110	219	235	79
TRA15	150	259	275	79

Current transformers - MEASURE

Open core single-phase current transformer



TRA230

TRA580

TRA812

TRA816

Cat. Nos.

TRA230

Busbar 20x30mm

Isr 5A	Isr 1A	Primary current (A)	Accuracy class VA		
			cl. 0.5	cl. 1	cl. 3
TA23050B600	TA23010B600	60A	-	-	1
TA23050C100	TA23010C100	100A	-	-	1.5
TA23050C150	TA23010C150	150A	-	1.5	2.5
TA23050C200	TA23010C200	200A	1	2.5	-
TA23050C250	TA23010C250	250A	1.5	3	-
TA23050C300	TA23010C300	300A	1.5	4	-
TA23050C400	TA23010C400	400A	2.5	6	-

Cat. Nos.

TRA580

Busbar 50x80mm

Isr 5A	Isr 1A	Primary current (A)	Accuracy class VA		
			cl. 0.5	cl. 1	cl. 3
TA58050C250	TA58010C250	250A	1	2	-
TA58050C300	TA58010C300	300A	1.5	3	-
TA58050C400	TA58010C400	400A	1.5	3	-
TA58050C500	TA58010C500	500A	2.5	5	-
TA58050C600	TA58010C600	600A	2.5	5	-
TA58050C800	TA58010C800	800A	3	7	-
TA58050D100	TA58010D100	1000A	5	10	-

Cat. Nos.

TRA812

Busbar 80x120mm

Isr 5A	Isr 1A	Primary current (A)	Accuracy class VA		
			cl. 0.5	cl. 1	cl. 3
TA81250C500	TA81210C500	500A	-	4	12
TA81250C600	TA81210C600	600A	-	5	14
TA81250C800	TA81210C800	800A	3	7	-
TA81250D100	TA81210D100	1000A	5	10	-
TA81250D120	TA81210D120	1200A	6	11	-
TA81250D150	TA81210D150	1500A	8	15	-

Cat. Nos.

TRA816

Busbar 80x160mm

Isr 5A	Isr 1A	Primary current (A)	Accuracy class VA		
			cl. 0.5	cl. 1	cl. 3
TA81650D200	TA81610D200	2000A	15	20	-
TA81650D250	TA81610D250	2500A	15	20	-
TA81650D300	TA81610D300	3000A	20	25	-
TA81650D400	TA81610D400	4000A	20	25	-
TA81650D500	TA81610D500	5000A	20	25	-

Cat. Nos.

Accessories

ATACOP13

Description
Accessory sealable terminal cover

Technical features

MODEL	TRA230	TRA580	TRA812	TRA816
TECHNICAL NOTES	NT869	NT841	NT842	NT863
SPECIFICATIONS				
Reference specification	EN/IEC 61869-1, 61869-2			
Rated primary current I _{pr} :	60÷400A	250÷1000A	500÷1500A	2000÷5000A
Rated frequency:	50Hz			
Working frequency:	47...63Hz			
Rated continuous thermal current I _{cth} :	100% I _{pr}			
Rated short-time thermal current I _{th} :	< 60I _{pr} (max.90kA/1s)			
Rated dynamic current I _{dyn} :	2,5I _{th}			
Instrument security factor (FS):	≤ 15			
Rated secondary current I _s :	1 - 5A			
Max. power dissipation	≤ 3.4W	≤ 10W	≤ 10W	≤ 26W
Allowed max cable or busbar temperature:	125°C			
INSULATION REQUIREMENTS				
Type	Dry transformer, air insulation			
Highest voltage for equipment U _m :	0.72kV r.m.s.			
Rated insulation level:	3kV r.m.s. 50Hz/1min			
Class of insulation (EN/IEC 61869-1, 61869-2):	B			
ENVIRONMENTAL CONDITIONS				
Nominal temperature range:	-25...50°C			
Limit temperature range for storage:	-40...85°C			
Relative humidity:	≤ 85%			
Suitable for tropical climates	yes			
CONNECTION				
Primary winding:	passing bus bar			
Secondary winding	4 screw terminals (max. cable section 6mm ²) + 2 fast-ons (4,8x0,8mm)			
MECHANICAL FEATURES				
Housing material:	self extinguishing			
Protection degree (EN/IEC 60529):	IP20 option sealable terminal			
Weight:	680 gr	1100 gr	1550 gr	3550 gr

Wiring diagrams

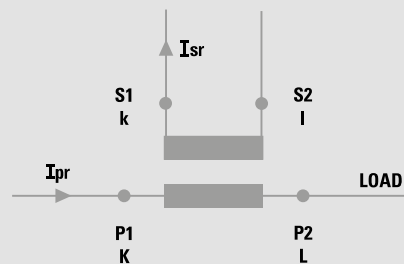

Dimensions

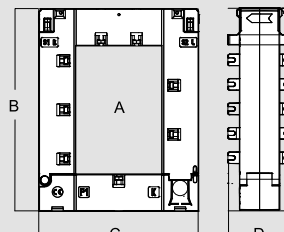

Dim. (mm)	A	B	C	D
TRA230	20x30	110	92	60
TRA580	50x80	150	120	55
TRA812	80x120	190	150	55
TRA816	80x160	230	185	70

Current transformers - MEASURE

Winding primary single-phase current transformer



TAQ2L - TAQ6L



TAQ2M - TAQ6M



TAQ10



TAQ20

Cat. Nos.		Primary current (A)	Accuracy class VA	
Isr 5A	Isr 1A		cl. 0.5	cl. 1
TAQ2M50A500	TAQ2M10A500	5A	2	4
TAQ2M50B100	TAQ2M10B100	10A	2	4
TAQ2M50B150	TAQ2M10B150	15A	2	4
TAQ2M50B200	TAQ2M10B200	20A	2	4
TAQ2M50B250	TAQ2M10B250	25A	2	4
TAQ2M50B300	TAQ2M10B300	30A	2	4
TAQ2M50B400	TAQ2M10B400	40A	2	4

Cat. Nos.		Primary current (A)	Accuracy class VA	
Isr 5A	Isr 1A		cl. 0.5	cl. 1
TAQ2L50B500	TAQ2L10B500	50A	2	4
TAQ2L50B600	TAQ2L10B600	60A	2	4
TAQ2L50B750	TAQ2L10B750	75A	2	4
TAQ2L50B800	TAQ2L10B800	80A	2	4
TAQ2L50C100	TAQ2L10C100	100A	2	4

Cat. Nos.		Primary current (A)	Accuracy class VA	
Isr 5A	Isr 1A		cl. 0.5	cl. 1
TAQ6M50A500	TAQ6M10A500	5A	6	7.5
TAQ6M50B100	TAQ6M10B100	10A	6	7.5
TAQ6M50B150	TAQ6M10B150	15A	6	7.5
TAQ6M50B200	TAQ6M10B200	20A	6	7.5
TAQ6M50B250	TAQ6M10B250	25A	6	7.5
TAQ6M50B300	TAQ6M10B300	30A	6	7.5
TAQ6M50B400	TAQ6M10B400	40A	6	7.5

Cat. Nos.		Primary current (A)	Accuracy class VA	
Isr 5A	Isr 1A		cl. 0.5	cl. 1
TAQ6L50B500	TAQ6L10B500	50A	6	7.5
TAQ6L50B600	TAQ6L10B600	60A	6	7.5
TAQ6L50B750	TAQ6L10B750	75A	6	7.5
TAQ6L50B800	TAQ6L10B800	80A	6	7.5

Cat. Nos.	Accessories
ATACOP13	Description Accessory sealable terminal cover for TAQ2M - TAQ2L - TAQ6M TAQ6L
ATACOP03	Accessory sealable terminal cover for TAQ10
ATACOP07	Accessory sealable terminal cover for TAQ20

Cat. Nos.		Primary current (A)	Accuracy class VA	
Isr 5A	Isr 1A		cl. 0.5	cl. 1
TAQC50A500	TAQC10A500	5A	10	15
TAQC50B100	TAQC10B100	10A	10	15
TAQC50B150	TAQC10B150	15A	10	15
TAQC50B200	TAQC10B200	20A	10	15
TAQC50B250	TAQC10B250	25A	10	15
TAQC50B300	TAQC10B300	30A	10	15
TAQC50B400	TAQC10B400	40A	10	15
TAQC50B500	TAQC10B500	50A	10	15
TAQC50B600	TAQC10B600	60A	10	15
TAQC50B700	TAQC10B700	70A	10	15
TAQC50B750	TAQC10B750	75A	10	15
TAQC50B800	TAQC10B800	80A	10	15
TAQC50C100	TAQC10C100	100A	10	15
TAQC50C120	TAQC10C120	120A	10	15
TAQC50C150	TAQC10C150	150A	10	15
TAQC50C200	TAQC10C200	200A	10	15
TAQC50C250	TAQC10C250	250A	10	15
TAQC50C300	TAQC10C300	300A	10	15

Cat. Nos.		Primary current (A)	Accuracy class VA	
Isr 5A	Isr 1A		cl. 0.5	cl. 1
TAQD50A500	TAQD10A500	5A	20	40
TAQD50B100	TAQD10B100	10A	20	40
TAQD50B150	TAQD10B150	15A	20	40
TAQD50B200	TAQD10B200	20A	20	40
TAQD50B250	TAQD10B250	25A	20	40
TAQD50B300	TAQD10B300	30A	20	40
TAQD50B400	TAQD10B400	40A	20	40
TAQD50B500	TAQD10B500	50A	20	40
TAQD50B600	TAQD10B600	60A	20	40
TAQD50B700	TAQD10B700	70A	20	40
TAQD50B750	TAQD10B750	75A	20	40
TAQD50B800	TAQD10B800	80A	20	40
TAQD50C100	TAQD10C100	100A	20	40
TAQD50C120	TAQD10C120	120A	20	40
TAQD50C150	TAQD10C150	150A	20	40
TAQD50C200	TAQD10C200	200A	20	40
TAQD50C250	TAQD10C250	250A	20	40
TAQD50C300	TAQD10C300	300A	20	40
TAQD50C400	TAQD10C400	400A	20	40
TAQD50C500	TAQD10C500	500A	20	40
TAQD50C600	TAQD10C600	600A	20	40

Current transformers - MEASURE

Winding primary single-phase current transformer

Technical features

MODEL	TAQ2M	TAQ6M	TAQ2L	TAQ6L	TAQ10	TAQ20
TECHNICAL NOTES	NT881	NT883	NT882	NT884	NT728	NT729
SPECIFICATIONS						
Reference specification	EN/IEC 61869-1, 61869-2					
Rated primary current I _{pr} :	5...40A	5...40A	50...100A	50...80A	5...300A	5...600A
Rated frequency:	50Hz					
Working frequency:	47...63Hz					
Rated continuous thermal current I _{cth} :	100% I _{pr}					
Rated short-time thermal current I _{th} :	< 60I _{pr}					
Rated dynamic current I _{dyn} :	2,5I _{th}					
Instrument security factor (FS):	≤ 5					
Rated secondary current I _{sr} :	5 - 1A					
Max. power dissipation	≤ 4.3W	≤ 4.3W	≤ 4.3W	≤ 4.3W	≤ 2.5W	≤ 2.5W
Allowed max cable or busbar temperature:	125°C					
INSULATION REQUIREMENTS						
Type	Dry transformer, air insulation					
Highest voltage for equipment U _m :	0.72kV r.m.s.					
Rated insulation level:	3kV r.m.s. 50Hz/1min					
Class of insulation (EN/IEC 61869-1, 61869-2):	B					
ENVIRONMENTAL CONDITIONS						
Nominal temperature range:	-25...50°C					
Limit temperature range for storage:	-40...85°C					
Relative humidity:	≤ 85%					
Suitable for tropical climates	yes					
CONNECTION						
Primary winding:	2 screw terminals (max. cable section 6mm ² , 10mm ² cable with lag)		Tightening by nut M6		built-in central bar (25x4mm)	built-in central bar (40x4mm)
Secondary winding	2 screw terminals (max. cable section 6mm ² , 10mm ² cable with lag)		4 screw terminals (max. cable section 6mm ²) + 2 fast-ons (4,8x0,8mm)		double screw M4	
MECHANICAL FEATURES						
Housing material:	self extinguishing polycarbonate					
Protection degree (EN/IEC 60529):	IP40 housing - IP20 terminals				IP20 housing, IP00 terminals (IP20 secondary terminals with sealable terminal cover)	
Mounting:	snap-on 35mm rail, screw type for wall mounting					
Weight:	250 gr	250 gr	300 gr	300 gr	700 gr	2000 gr

Dimensions

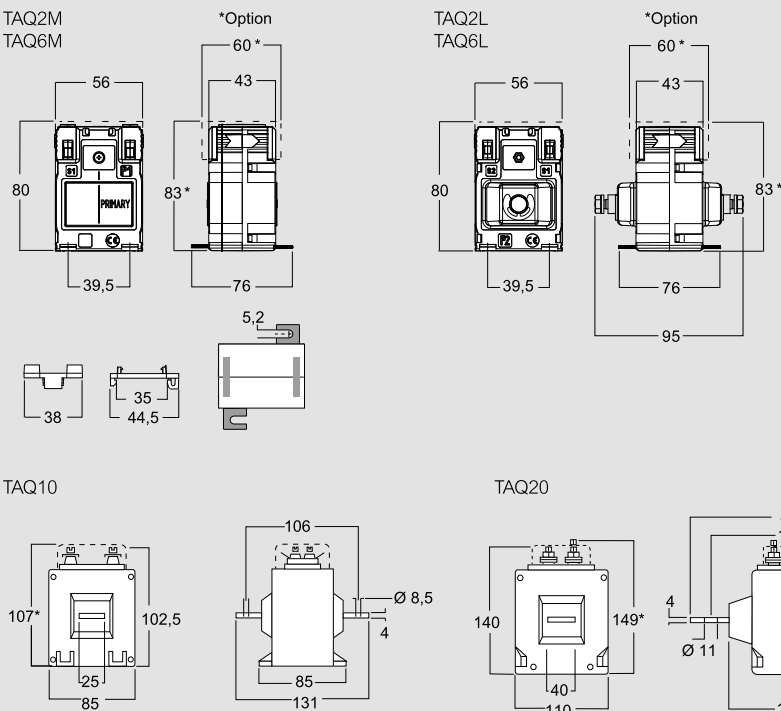

Wiring diagrams

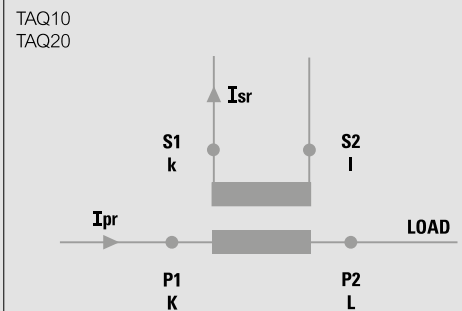

Current transformers - MEASURE

Cable/passing bar single-phase current transformer



TAIBB

TA221

Cat. Nos.

TAIBB

Passing cable window/bar Ø 21mm - 16,5x12,5mm

Isr 5A	Isr 1A	Primary current (A)	Accuracy class VA		
			cl. 0.5	cl. 1	cl.3
TABB50B400	TABB10B400	40	-	-	1
TABB50B500	TABB10B500	50	-	1	1.5
TABB50B600	TABB10B600	60	-	1	2
TABB50B700	TABB10B700	70	-	1.5	2.5
TABB50B750	TABB10B750	75	-	1.5	2.5
TABB50B800	TABB10B800	80	-	1.5	2.5
TABB50C100	TABB10C100	100	1.5	2.5	3.5
TABB50C120	TABB10C120	120	2	3.5	
TABB50C125	TABB10C125	125	2	3.5	
TABB50C150	TABB10C150	150	3	4	
TABB50C160	TABB10C160	160	3	4	
TABB50C200	TABB10C200	200	4	5.5	
TABB50C250		250	5	6	
TABB50C300		300	6	7.5	

Cat. Nos.

TA221

Passing cable window/bar Ø 21mm - 20,5x10,5mm

Isr 5A	Isr 1A	Primary current (A)	Accuracy class VA		
			cl. 0.5	cl. 1	cl.3
TA22150B500	TA22110B500	50	-	-	2.5
TA22150B600	TA22110B600	60	-	1.5	3
TA22150B700	TA22110B700	70	-	1.5	4
TA22150B750	TA22110B750	75	-	2	4
TA22150B800	TA22110B800	80	-	3	4
TA22150C100	TA22110C100	100	2.5	4	-
TA22150C120	TA22110C120	120	2.5	4	-
TA22150C125	TA22110C125	125	2.5	4	-
TA22150C150	TA22110C150	150	4	6	-
TA22150C160	TA22110C160	160	4	6	-
TA22150C200	TA22110C200	200	6	8	-
TA22150C250	TA22110C250	250	8	10	-
TA22150C300		300	8	10	-

Cat. Nos.

Accessories

Description

ATACOP12	Accessory sealable terminal cover for TAIBB
ATACOP13	Accessory sealable terminal cover for TA221

Technical features

MODEL	TAIBB	TA221
TECHNICAL NOTES	NT516	NT811
SPECIFICATIONS		
Reference specification	EN/IEC 61869-1, 61869-2	
Rated primary current I _{pr} :	40...300A (with secondary 5A)	50...300A (with secondary 5A)
	40...200A (with secondary 1A)	50...250A (with secondary 1A)
Rated frequency:	50Hz	
Working frequency:	47...63Hz	
Rated continuous thermal current I _{cth} :	100% I _{pr}	
Rated short-time thermal current I _{th} :	< 60I _{pr}	
Rated dynamic current I _{dyn} :	2,5I _{th}	
Instrument security factor (FS):	≤ 5	
Rated secondary current I _{sr} :	5 - 1A (Isr 1A not available with I _{pr} 250 and 300A)	
Max. power dissipation	≤ 3W	≤ 4W at I _{cth}
Allowed max cable or busbar temperature:	125°C	
INSULATION REQUIREMENTS		
Type	Dry transformer, air insulation	
Highest voltage for equipment U _m :	0.72kV r.m.s.	
Rated insulation level:	3kV r.m.s. 50Hz/1min	
Class of insulation (EN/IEC 61869-1, 61869-2):	B	
ENVIRONMENTAL CONDITIONS		
Nominal temperature range:	-25...50°C	
Limit temperature range for storage:	-40...85°C	
Relative humidity:	≤ 85%	
Suitable for tropical climates	yes	
CONNECTION		
Primary winding:	passing cable	
Secondary winding	screw terminals, max 2 separated wires 2,5mm ²	4 screw terminals (max. cable section 6mm ²)+ 2 fast-ons (4,8x0,8mm)
MECHANICAL FEATURES		
Housing material:	self extinguishing polycarbonate	
Protection degree (EN/IEC 60529):	IP40 housing - IP20 terminals	
Mounting:	snap-on 35mm rail, screw type for wall mounting	
Weight:	180 gr	320 gr

Wiring diagrams

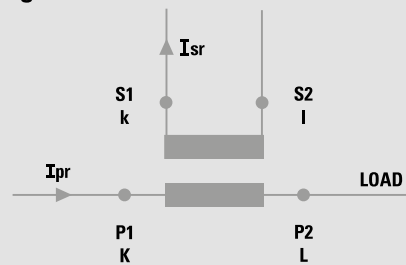

Dimensions

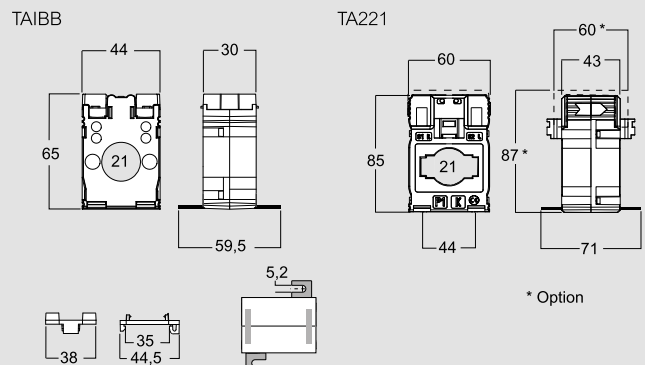

Current transformers - MEASURE

Cable/passing bar single-phase current transformer



TA327



TA426

Cat. Nos.

TA327

Passing cable window/bar Ø 27mm - 25.5x15.5mm - 32.5x10.5mm

Isr 5A	Isr 1A	Primary current (A)	Accuracy class VA		
			cl. 0.5	cl. 1	cl.3
TA32750B500	TA32710B500	50	-	-	1.5
TA32750B600	TA32710B600	60	-	-	2.5
TA32750B700	TA32710B700	70	-	1.5	3
TA32750B750	TA32710B750	75	-	1.5	3
TA32750B800	TA32710B800	80	-	2.5	3.5
TA32750C100	TA32710C100	100	2	3	-
TA32750C120	TA32710C120	120	2	3.5	-
TA32750C125	TA32710C125	125	2	3.5	-
TA32750C150	TA32710C150	150	3	4	-
TA32750C160	TA32710C160	160	3	5	-
TA32750C200	TA32710C200	200	4	7	-
TA32750C250	TA32710C250	250	6	8	-
TA32750C300	TA32710C300	300	8	10	-
TA32750C400	TA32710C400	400	10	12	-
TA32750C500	TA32710C500	500	12	15	-
TA32750C600	TA32710C600	600	15	20	-

Cat. Nos.

TA426

Passing cable window/bar Ø 26mm - 32.5x15.5mm - 40.5x12.5mm

Isr 5A	Isr 1A	Primary current (A)	Accuracy class VA		
			cl. 0.5	cl. 1	cl. 1
TA42650C150	TA42610C150	150A	1.5	3	3
TA42650C160	TA42610C160	160A	1.5	3	3
TA42650C200	TA42610C200	200A	2.5	4	4
TA42650C250	TA42610C250	250A	3	4	4
TA42650C300	TA42610C300	300A	4	6	6
TA42650C400	TA42610C400	400A	6	8	8
TA42650C500	TA42610C500	500A	6	8	8
TA42650C600	TA42610C600	600A	6	8	8
TA42650C700	TA42610C700	700A	8	10	10
TA42650C750	TA42610C750	750A	8	10	10
TA42650C800	TA42610C800	800A	10	12	12

Cat. Nos.

Accessories

ATACOP13

Description
Accessory sealable terminal cover

Technical features

MODEL	TA327	TA426
TECHNICAL NOTES	NT812	NT813
SPECIFICATIONS		
Reference specification	EN/IEC 61869-1, 61869-2	
Rated primary current I _{pr} :	50...600A	150...800A
Rated frequency:	50Hz	
Working frequency:	47...63Hz	
Rated continuous thermal current I _{cth} :	100% I _{pr}	
Rated short-time thermal current I _{th} :	< 60I _{pr}	
Rated dynamic current I _{dyn} :	2,5I _{th}	
Instrument security factor (FS):	≤ 5	
Rated secondary current I _{sr} :	1-5A	
Max. power dissipation	≤ 7W at I _{cth}	≤ 11.5W at I _{cth}
Allowed max cable or busbar temperature:	125°C	
INSULATION REQUIREMENTS		
Type	Dry transformer, air insulation	
Highest voltage for equipment U _m :	0.72kV r.m.s.	
Rated insulation level:	3kV r.m.s. 50Hz/1min	
Class of insulation (EN/IEC 61869-1, 61869-2):	B	
ENVIRONMENTAL CONDITIONS		
Nominal temperature range:	-25...50°C	
Limit temperature range for storage:	-40...85°C	
Relative humidity:	≤ 85%	
Suitable for tropical climates	yes	
CONNECTION		
Primary winding:	passing cable/bus bar primary	
Secondary winding	4 screw terminals (max. cable section 6mm ²) + 2 fast-ons (4,8x0,8mm)	
MECHANICAL FEATURES		
Housing material:	self extinguishing polycarbonate	
Protection degree (EN/IEC 60529):	IP40 housing - IP20 terminals	
Mounting:	snap-on 35mm rail, screw type for wall mounting	
Weight:	260 gr	300 gr

Wiring diagrams

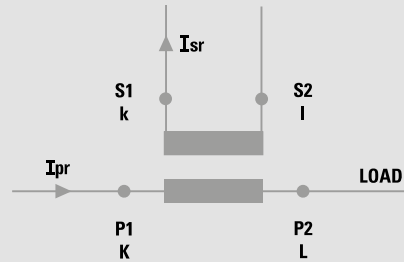

Dimensions

TA327

TA426

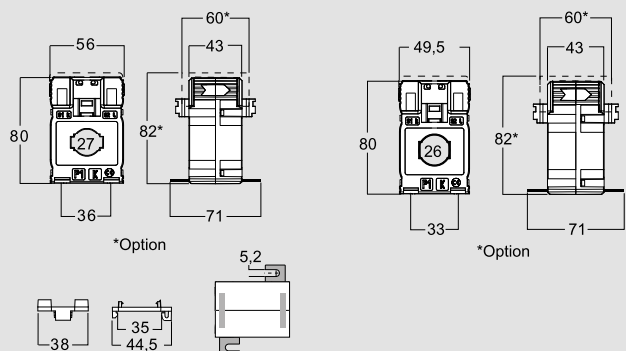

Current transformers - MEASURE

Cable/passing bar single-phase current transformer



TA432



TA540

Cat. Nos.

TA432

Passing cable window/bar Ø 32mm - 25,5x25,5mm - 32,5x20,5mm - 40,5x10,5mm

Isr 5A	Isr 1A	Primary current (A)	Accuracy class VA		
			cl. 0.5	cl. 1	cl.3
TA43250C100	TA43210C100	100A	-	2	5
TA43250C120	TA43210C120	120A	-	2	5
TA43250C125	TA43210C125	125A	-	2	6
TA43250C150	TA43210C150	150A	1	3	-
TA43250C160	TA43210C160	160A	1.5	3	-
TA43250C200	TA43210C200	200A	3	5	-
TA43250C250	TA43210C250	250A	3	5	-
TA43250C300	TA43210C300	300A	5	8	-
TA43250C400	TA43210C400	400A	8	10	-
TA43250C500	TA43210C500	500A	10	12	-
TA43250C600	TA43210C600	600A	12	15	-
TA43250C700	TA43210C700	700A	10	12	-
TA43250C750	TA43210C750	750A	10	12	-
TA43250C800	TA43210C800	800A	10	12	-
TA43250D100	TA43210D100	1000A	12	15	-

Cat. Nos.

TA540

Passing cable window/bar Ø 40mm - 40,5x20,5mm - 50,5x12,5mm - 40,5x10,5mm

Isr 5A	Isr 1A	Primary current (A)	Accuracy class VA	
			cl. 0.5	cl. 1
TA54050C300	TA54010C300	300A	2	4
TA54050C400	TA54010C400	400A	4	6
TA54050C500	TA54010C500	500A	4	6
TA54050C600	TA54010C600	600A	6	8
TA54050C700	TA54010C700	700A	8	10
TA54050C750	TA54010C750	750A	8	10
TA54050C800	TA54010C800	800A	8	12
TA54050D100	TA54010D100	1000A	10	12
TA54050D120	TA54010D120	1200A	12	15

Cat. Nos.

Accessories

ATACOP13

Description
Accessory sealable terminal cover

Technical features

MODEL	TA432	TA540
TECHNICAL NOTES	NT814	NT815
SPECIFICATIONS		
Reference specification	EN/IEC 61869-1, 61869-2	
Rated primary current Ipr:	100...1000A	300...1200A
Rated frequency:	50Hz	
Working frequency:	47...63Hz	
Rated continuous thermal current Icth:	100% Ipr	
Rated short-time thermal current Ith:	< 60Ipr	
Rated dynamic current Idyn :	2,5Ith	
Instrument security factor (FS):	≤ 5	
Rated secondary current Isr :	5 - 1A	
Max. power dissipation	≤ 9W at Icth	≤ 10.5W at Icth
Allowed max cable or busbar temperature:	125°C	
INSULATION REQUIREMENTS		
Type	Dry transformer, air insulation	
Highest voltage for equipment Um:	0.72kV r.m.s.	
Rated insulation level:	3kV r.m.s. 50Hz/1min	
Class of insulation (EN/IEC 61869-1, 61869-2):	B	
ENVIRONMENTAL CONDITIONS		
Nominal temperature range:	-25...50°C	
Limit temperature range for storage:	-40...85°C	
Relative humidity:	≤ 85%	
Suitable for tropical climates	yes	
CONNECTION		
Primary winding:	Passing cable/bus bar primary	
Secondary winding	4 screw terminals (max. cable section 6mm ²) + 2 fast-ons (4,8x0,8mm)	
MECHANICAL FEATURES		
Housing material:	self extinguishing polycarbonate	
Protection degree (EN/IEC 60529):	IP40 housing - IP20 terminals	
Mounting:	snap-on 35mm rail, screw type for wall mounting	
Weight:	420 gr	320 gr

Wiring diagrams

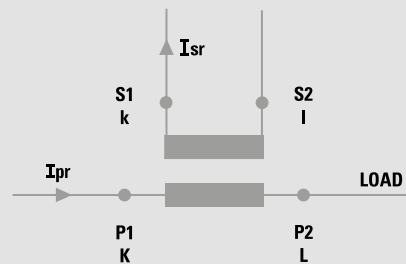

Dimensions

TA432

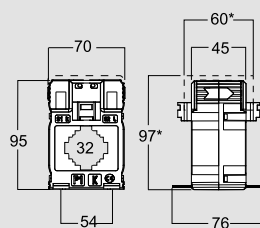

*Option

TA540

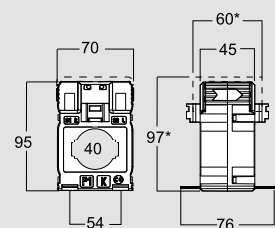

*Option

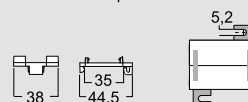

Current transformers - MEASURE

Cable/passing bar single-phase current transformer



TAC80



TAC110

Cat. Nos.		TAC80	
Passing cable window/bar Ø 80mm			
Isr 5A	Primary current (A)	Accuracy class VA	
		cl. 0.5	cl. 1
TA0850C200	200A	1.5	3
TA0850C250	250A	2	4
TA0850C300	300A	2.5	5
TA0850C400	400A	3	5
TA0850C500	500A	3	5
TA0850C600	600A	4	6
TA0850C800	800A	4	6
TA0850D100	1000A	6	8

Cat. Nos.		TAC110	
Passing cable window/bar Ø 110mm			
Isr 5A	Primary current (A)	Accuracy class VA	
		cl. 0.5	cl. 1
TA1150C400	400A	3	5
TA1150C500	500A	3	5
TA1150C600	600A	4	6
TA1150C800	800A	4	6
TA1150D100	1000A	8	10
TA1150D120	1200A	8	10
TA1150D150	1500A	10	12

Technical features

MODEL	TAC80	TAC110
TECHNICAL NOTES	NT712	NT713
SPECIFICATIONS		
Reference specification	EN/IEC 61869-1, 61869-2	
Rated primary current Ipr:	200...1000A	400...1500A
Rated frequency:	50Hz	
Working frequency:	47...63Hz	
Rated continuous thermal current Icth:	100% Ipr	
Rated short-time thermal current Ith:	< 60Ipr	
Rated dynamic current Idyn :	2,5Ith	
Instrument security factor (FS):	≤ 5	
Rated secondary current Isr :	5A	
Max. power dissipation	≤ 7.5W at Icth	≤ 10.5W at Icth
Allowed max cable or busbar temperature:	125°C	
INSULATION REQUIREMENTS		
Type	Dry transformer, air insulation	
Highest voltage for equipment Um:	0.72kV r.m.s.	
Rated insulation level:	3kV r.m.s. 50Hz/1min	
Class of insulation (EN/IEC 61869-1, 61869-2):	B	
ENVIRONMENTAL CONDITIONS		
Nominal temperature range:	-25...50°C	
Limit temperature range for storage:	-40...85°C	
Relative humidity:	≤ 85%	
Suitable for tropical climates	yes	
CONNECTION		
Primary winding:	Passing cable	
Secondary winding	2 screw terminals (2x2.5mm ²)	
MECHANICAL FEATURES		
Housing material:	self extinguishing polycarbonate	
Protection degree (EN/IEC 60529):	IP40 housing - IP20 terminals	
Mounting:	screw type for wall mounting	
Weight:	500 gr	650 gr

Wiring diagrams

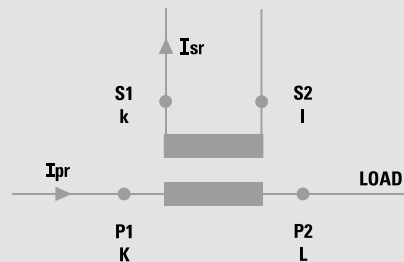

Dimensions

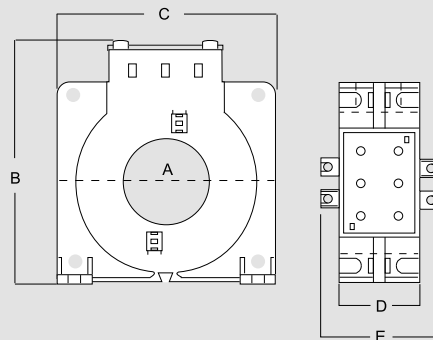

Dim. (mm)	A	B	C	D	E
TAC80	80	132	125	36	56
TAC110	110	170	165	36	56

Current transformers - MEASURE

Cable/passing bar single-phase current transformer



TAS64

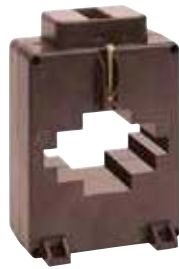

TAS81

Cat. Nos.

TAS64

Passing cable window/bar 51x31mm - 64x11mm

Isr 5A	Isr 1A	Primary current (A)	Accuracy class VA	
			cl. 0.5	cl. 1
TASI50C250	TASI10C250	250A	-	2.5
TASI50C300	TASI10C300	300A	-	3
TASI50C400	TASI10C400	400A	-	4
TASI50C500	TASI10C500	500A	2	4
TASI50C600	TASI10C600	600A	4	6
TASI50C700	TASI10C700	700A	6	8
TASI50C750	TASI10C750	750A	6	8
TASI50C800	TASI10C800	800A	6	8
TASI50D100	TASI10D100	1000A	5	10
TASI50D120	TASI10D120	1200A	10	12
TASI50D125	TASI10D125	1250A	10	12
TASI50D150	TASI10D150	1500A	10	12
TASI50D160	TASI10D160	1600A	10	12

Cat. Nos.

TAS81

Passing cable window/bar 64x31mm - 81x11mm

Isr 5A	Isr 1A	Primary current (A)	Accuracy class VA	
			cl. 0.5	cl. 1
TASN50C400	TASN10C400	400A	-	2
TASN50C500	TASN10C500	500A	2	4
TASN50C600	TASN10C600	600A	3	5
TASN50C700	TASN10C700	700A	4	6
TASN50C750	TASN10C750	750A	4	6
TASN50C800	TASN10C800	800A	4	6
TASN50D100	TASN10D100	1000A	6	8
TASN50D120	TASN10D120	1200A	8	10
TASN50D125	TASN10D125	1250A	8	10
TASN50D150	TASN10D150	1500A	10	12
TASN50D160	TASN10D160	1600A	10	12
TASN50D200	TASN10D200	2000A	10	12
TASN50D250	TASN10D250	2500A	10	12

Cat. Nos.

Accessories

Description
ATACOP03 Accessory sealable terminal cover

Technical features

MODEL	TAS64	TAS81
TECHNICAL NOTES	NT569	NT573
SPECIFICATIONS		
Reference specification	EN/IEC 61869-1, 61869-2	
Rated primary current I _{pr} :	250...1600A	400...2500A
Rated frequency:	50Hz	
Working frequency:	47...63Hz	
Rated continuous thermal current I _{cth} :	100% I _{pr}	
Rated short-time thermal current I _{th} :	< 60I _{pr}	
Rated dynamic current I _{dyn} :	2,5I _{th}	
Instrument security factor (FS):	≤ 5	
Rated secondary current I _{sr} :	5 - 1A	
Max. power dissipation	≤ 16W at I _{cth}	≤ 14.5W at I _{cth}
Allowed max cable or busbar temperature:	125°C	
INSULATION REQUIREMENTS		
Type	Dry transformer, air insulation	
Highest voltage for equipment U _m :	0.72kV r.m.s.	
Rated insulation level:	3kV r.m.s. 50Hz/1min	
Class of insulation (EN/IEC 61869-1, 61869-2):	B	
ENVIRONMENTAL CONDITIONS		
Nominal temperature range:	-25...50°C	
Limit temperature range for storage:	-40...85°C	
Relative humidity:	≤ 85%	
Suitable for tropical climates	yes	
CONNECTION		
Primary winding:	Passing bus bar	
Secondary winding	tightening by nut M4	
MECHANICAL FEATURES		
Housing material:	self extinguishing polycarbonate	
Protection degree (EN/IEC 60529):	P40 housing - IP00 terminals (IP20 with sealable terminal cover)	
Weight:	500 gr	470 gr

Wiring diagrams

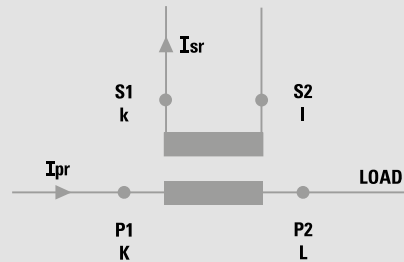

Dimensions

TAS64

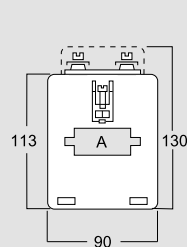

TAS81

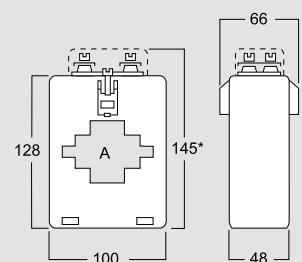

Current transformers - MEASURE

Cable/passing bar single-phase current transformers



TAS65

TAS84

Cat. Nos.				TAS65		
Bars in VERTICAL		Bars in HORIZONTAL		Primary current (A)	Accuracy class VA	
Isr 5A	Isr 1A	Isr 5A	Isr 1A		cl. 0.5	cl. 1
TASL50C250	TASL10C250	TASL50C2503	TASL10C2503	250A	1	4
TASL50C300	TASL10C300	TASL50C3003	TASL10C3003	300A	1.5	6
TASL50C400	TASL10C400	TASL50C4003	TASL10C4003	400A	4	8
TASL50C500	TASL10C500	TASL50C5003	TASL10C5003	500A	8	10
TASL50C600	TASL10C600	TASL50C6003	TASL10C6003	600A	8	12
TASL50C700	TASL10C700	TASL50C7003	TASL10C7003	700A	10	12
TASL50C750	TASL10C750	TASL50C7503	TASL10C7503	750A	10	15
TASL50C800	TASL10C800	TASL50C8003	TASL10C8003	800A	12	15
TASL50D100	TASL10D100	TASL50D1003	TASL10D1003	1000A	15	20
TASL50D120	TASL10D120	TASL50D1203	TASL10D1203	1200A	15	20
TASL50D125	TASL10D125	TASL50D1253	TASL10D1253	1250A	15	20
TASL50D150	TASL10D150	TASL50D1503	TASL10D1503	1500A	20	25
TASL50D160	TASL10D160	TASL50D1603	TASL10D1603	1600A	20	25
TASL50D200	TASL10D200	TASL50D2003	TASL10D2003	2000A	20	25

Passing cable window/bar 32x65mm and 65x32mm - long side terminals

Cat. Nos.				TAS84		
Bars in VERTICAL		Bars in HORIZONTAL		Primary current (A)	Accuracy class VA	
Isr 5A	Isr 1A	Isr 5A	Isr 1A		cl. 0.5	cl. 1
TASO50C300	TASO10C300	TASO50C3003	TASO10C3003	300A	-	2
TASO50C400	TASO10C400	TASO50C4003	TASO10C4003	400A	3	5
TASO50C500	TASO10C500	TASO50C5003	TASO10C5003	500A	5	7
TASO50C600	TASO10C600	TASO50C6003	TASO10C6003	600A	6	10
TASO50C700	TASO10C700	TASO50C7003	TASO10C7003	700A	6	10
TASO50C750	TASO10C750	TASO50C7503	TASO10C7503	750A	8	12
TASO50C800	TASO10C800	TASO50C8003	TASO10C8003	800A	8	12
TASO50D100	TASO10D100	TASO50D1003	TASO10D1003	1000A	10	15
TASO50D120	TASO10D120	TASO50D1203	TASO10D1203	1200A	12	15
TASO50D125	TASO10D125	TASO50D1253	TASO10D1253	1250A	12	15
TASO50D150	TASO10D150	TASO50D1503	TASO10D1503	1500A	15	20
TASO50D160	TASO10D160	TASO50D1603	TASO10D1603	1600A	15	20
TASO50D200	TASO10D200	TASO50D2003	TASO10D2003	2000A	20	25
TASO50D250	TASO10D250	TASO50D2503	TASO10D2503	2500A	25	30

Passing cable window/bar 34x84mm and 84x34mm - long side terminals

Cat. Nos.	Accessories
	Description
ATACOP04	Accessory sealable terminal cover
ATADIS03	profile for 50mm bars (for TAS65)
ATADIS01	profile for 60mm bars (for TAS84)
ATAFIS01	2 metallic feet for wall mounting (for TAS65)

Technical features

MODEL	TAS65	TAS84
TECHNICAL NOTES	NT518	NT574
SPECIFICATIONS		
Reference specification	EN/IEC 61869-1, 61869-2	
Rated primary current Ipr:	250...2000A	300...2500A
Rated frequency:	50Hz	
Working frequency:	47...63Hz	
Rated continuous thermal current Icth:	100% Ipr	
Rated short-time thermal current Ith:	< 60Ipr	
Rated dynamic current Idyn :	2,5Ith	
Instrument security factor (FS):	≤ 5	
Rated secondary current Isr :	5 - 1A	
Max. power dissipation	≤ 20W	≤ 19W
Allowed max cable or busbar temperature:	125°C	
INSULATION REQUIREMENTS		
Type	Dry transformer, air insulation	
Highest voltage for equipment Um:	0.72kV r.m.s.	
Rated insulation level:	3kV r.m.s. 50Hz/1min	
Class of insulation (EN/IEC 61869-1, 61869-2):	B	
ENVIRONMENTAL CONDITIONS		
Nominal temperature range:	-25...50°C	
Limit temperature range for storage:	-40...85°C	
Relative humidity:	≤ 85%	
Suitable for tropical climates	yes	
CONNECTION		
Primary winding:	Passing bus bar	
Secondary winding:	tightening by nut M4	
MECHANICAL FEATURES		
Housing material:	self extinguishing polycarbonate	
Protection degree (EN/IEC 60529):	P40 housing - IP00 terminals (IP20 with sealable terminal cover)	
Mounting:	screw type on bar	
Weight:	750 gr	750 gr

Wiring diagrams

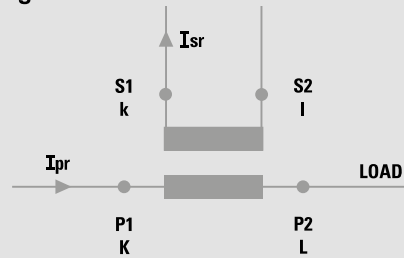

Dimensions

TAS127

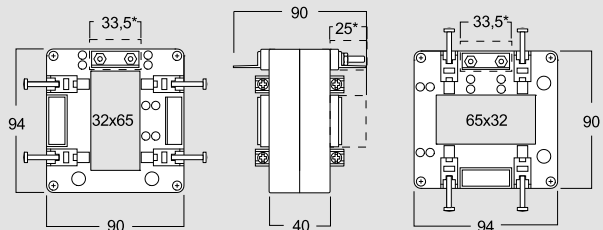

TAS127B

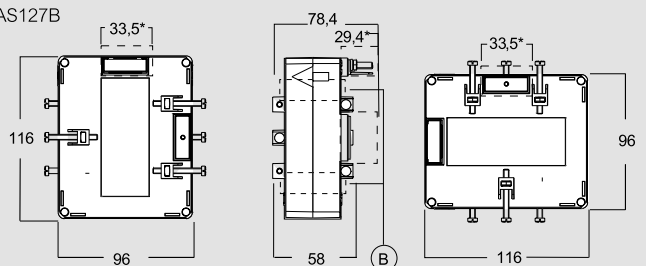

*OptionB = Spacing device

Current transformers - MEASURE

Cable/passing bar single-phase current transformer



TAS102

TAS102B

Cat. Nos.				Primary current (A)	Accuracy class VA	
Bars in VERTICAL		Bars in HORIZONTAL			cl. 0.5	cl. 1
Isr 5A	Isr 1A	Isr 5A	Isr 1A			
TAMP50C800	TAMP10C800	TAMP50C8003	TAMP10C8003	800A	8	10
TAMP50D100	TAMP10D100	TAMP50D1003	TAMP10D1003	1000A	10	12
TAMP50D120	TAMP10D120	TAMP50D1203	TAMP10D1203	1200A	12	15
TAMP50D125	TAMP10D125	TAMP50D1253	TAMP10D1253	1250A	12	15
TAMP50D150	TAMP10D150	TAMP50D1503	TAMP10D1503	1500A	12	15
TAMP50D160	TAMP10D160	TAMP50D1603	TAMP10D1603	1600A	12	15
TAMP50D200	TAMP10D200	TAMP50D2003	TAMP10D2003	2000A	20	25
TAMP50D250	TAMP10D250	TAMP50D2503	TAMP10D2503	2500A	20	25
TAMP50D300	TAMP10D300	TAMP50D3003	TAMP10D3003	3000A	20	25

TAS102
 Passing cable window/bar
 38x102mm and 102x38mm -
 long side terminals

Cat. Nos.				Primary current (A)	Accuracy class VA	
Bars in VERTICAL		Bars in HORIZONTAL			cl. 0.5	cl. 1
Isr 5A	Isr 1A	Isr 5A	Isr 1A			
TAMQ50C800	TAMQ10C800	TAMQ50C8003	TAMQ10C8003	800A	10	12
TAMQ50D100	TAMQ10D100	TAMQ50D1003	TAMQ10D1003	1000A	12	15
TAMQ50D120	TAMQ10D120	TAMQ50D1203	TAMQ10D1203	1200A	15	20
TAMQ50D125	TAMQ10D125	TAMQ50D1253	TAMQ10D1253	1250A	15	20
TAMQ50D150	TAMQ10D150	TAMQ50D1503	TAMQ10D1503	1500A	20	25
TAMQ50D160	TAMQ10D160	TAMQ50D1603	TAMQ10D1603	1600A	20	25
TAMQ50D200	TAMQ10D200	TAMQ50D2003	TAMQ10D2003	2000A	20	25
TAMQ50D250	TAMQ10D250	TAMQ50D2503	TAMQ10D2503	2500A	25	30
TAMQ50D300	TAMQ10D300	TAMQ50D3003	TAMQ10D3003	3000A	25	30
TAMQ50D320	TAMQ10D320	TAMQ50D3203	TAMQ10D3203	3200A	25	30
TAMQ50D400	TAMQ10D400	TAMQ50D4003	TAMQ10D4003	4000A	30	40

TAS102B
 Passing cable window/bar
 54x102mm and 102x54mm -
 long side terminals

Cat. Nos.	Accessories
	Description
ATACOP04	Accessory sealable terminal cover
ATAFIS01	Screw type for wall mounting

Technical features

MODEL	TAS102	TAS102B
TECHNICAL NOTES	NT766	NT767
SPECIFICATIONS		
Reference specification	EN/IEC 61869-1, 61869-2	
Rated primary current I _{pr} :	800...3000A	800...4000A
Rated frequency:	50Hz	
Working frequency:	47...63Hz	
Rated continuous thermal current I _{cth} :	100% I _{pr}	
Rated short-time thermal current I _{th} :	< 60I _{pr}	
Rated dynamic current I _{dyn} :	2,5I _{th}	
Instrument security factor (FS):	≤ 5	
Rated secondary current I _s :	5 - 1A	
Max. power dissipation	≤ 25W	≤ 25W
Allowed max cable or busbar temperature:	125°C	
INSULATION REQUIREMENTS		
Type	Dry transformer, air insulation	
Highest voltage for equipment U _m :	0.72kV r.m.s.	
Rated insulation level:	3kV r.m.s. 50Hz/1min	
Class of insulation (EN/IEC 61869-1, 61869-2):	B	
ENVIRONMENTAL CONDITIONS		
Nominal temperature range:	-25...50°C	
Limit temperature range for storage:	-40...85°C	
Relative humidity:	≤ 85%	
Suitable for tropical climates	yes	
CONNECTION		
Primary winding:	Passing bus bar	
Secondary winding:	tightening by nut M4	
MECHANICAL FEATURES		
Housing material:	self extinguishing polycarbonate	
Protection degree (EN/IEC 60529):	P40 housing - IP00 terminals (IP20 with sealable terminal cover)	
Mounting:	screw type on bar	
Weight:	1000 gr	1200 gr

Wiring diagrams

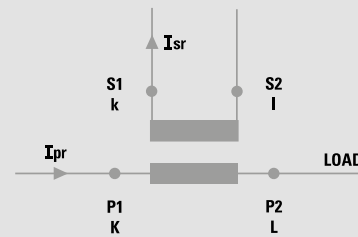

Dimensions

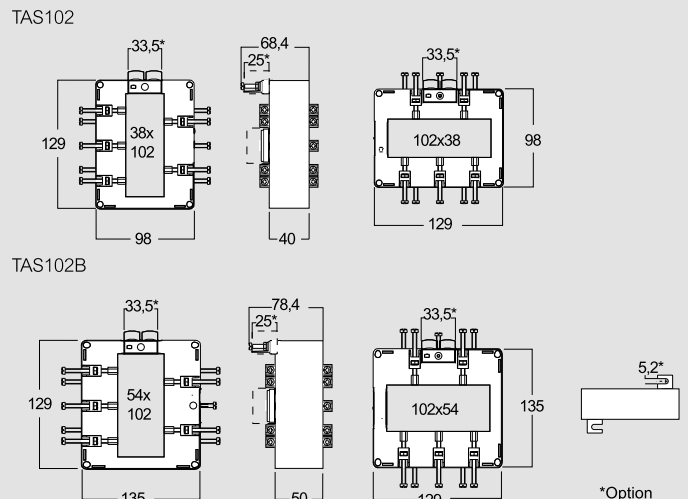

Current transformers - MEASURE

Cable/passing bar single-phase current transformer

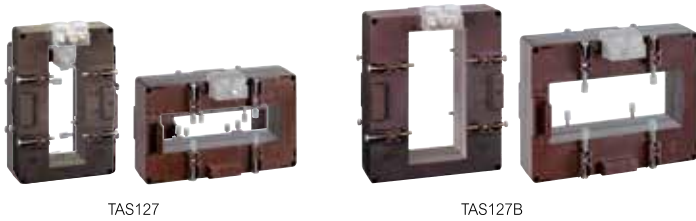

TAS127

TAS127B

Cat. Nos.				TAS127		
Bars in VERTICAL		Bars in HORIZONTAL		Primary current (A)	Accuracy class VA	
Isr 5A	Isr 1A	Isr 5A	Isr 1A		cl. 0.5	cl. 1
TASR50C400	TASR10C400	TASR50C4003	TASR10C4003	400A	-	3
TASR50C500	TASR10C500	TASR50C5003	TASR10C5003	500A	2	4
TASR50C600	TASR10C600	TASR50C6003	TASR10C6003	600A	4	6
TASR50C700	TASR10C700	TASR50C7003	TASR10C7003	700A	4	8
TASR50C750	TASR10C750	TASR50C7503	TASR10C7503	750A	4	8
TASR50C800	TASR10C800	TASR50C8003	TASR10C8003	800A	4	8
TASR50D100	TASR10D100	TASR50D1003	TASR10D1003	1000A	6	10
TASR50D120	TASR10D120	TASR50D1203	TASR10D1203	1200A	8	12
TASR50D125	TASR10D125	TASR50D1253	TASR10D1253	1250A	8	12
TASR50D150	TASR10D150	TASR50D1503	TASR10D1503	1500A	10	15
TASR50D160	TASR10D160	TASR50D1603	TASR10D1603	1600A	10	15
TASR50D200	TASR10D200	TASR50D2003	TASR10D2003	2000A	15	20
TASR50D250	TASR10D250	TASR50D2503	TASR10D2503	2500A	20	25
TASR50D300	TASR10D300	TASR50D3003	TASR10D3003	3000A	25	30
TASR50D320	TASR10D320	TASR50D3203	TASR10D3203	3200A	25	30
TASR50D400	TASR10D400	TASR50D4003	TASR10D4003	4000A	25	30

Passing cable window/bar 38x127mm and 127x38mm - long side terminals

Cat. Nos.				TAS127B		
Bars in VERTICAL		Bars in HORIZONTAL		Primary current (A)	Accuracy class VA	
Isr 5A	Isr 1A	Isr 5A	Isr 1A		cl. 0.5	cl. 1
TASS50C4003	TASS10C4003	TASS50C4003	TASS10C4003	400A	1	7
TASS50C5003	TASS10C5003	TASS50C5003	TASS10C5003	500A	3	10
TASS50C6003	TASS10C6003	TASS50C6003	TASS10C6003	600A	5	12
TASS50C7003	TASS10C7003	TASS50C7003	TASS10C7003	700A	8	15
TASS50C7503	TASS10C7503	TASS50C7503	TASS10C7503	750A	10	15
TASS50C8003	TASS10C8003	TASS50C8003	TASS10C8003	800A	10	15
TASS50D1003	TASS10D1003	TASS50D1003	TASS10D1003	1000A	12	20
TASS50D1203	TASS10D1203	TASS50D1203	TASS10D1203	1200A	15	25
TASS50D1253	TASS10D1253	TASS50D1253	TASS10D1253	1250A	15	25
TASS50D1503	TASS10D1503	TASS50D1503	TASS10D1503	1500A	20	30
TASS50D1603	TASS10D1603	TASS50D1603	TASS10D1603	1600A	20	30
TASS50D2003	TASS10D2003	TASS50D2003	TASS10D2003	2000A	25	30
TASS50D2503	TASS10D2503	TASS50D2503	TASS10D2503	2500A	30	50
TASS50D3003	TASS10D3003	TASS50D3003	TASS10D3003	3000A	30	50
TASS50D3203	TASS10D3203	TASS50D3203	TASS10D3203	3200A	30	50
TASS50D4003	TASS10D4003	TASS50D4003	TASS10D4003	4000A	30	50

Passing cable window/bar 54x127mm and 127x54mm - long side terminals

Cat. Nos.	Accessories
ATACOP04	Accessory sealable terminal cover
ATADIS02	Spacing device for bars of 100 mm
ATAFIS01	Screw type for wall mounting

Technical features

MODEL	TAS127	TAS127B
TECHNICAL NOTES	NT522	NT523
SPECIFICATIONS		
Reference specification	EN/IEC 61869-1, 61869-2	
Rated primary current I _{pr} :	400...4000A	800...4000A
Rated frequency:	50Hz	
Working frequency:	47...63Hz	
Rated continuous thermal current I _{cth} :	100% I _{pr}	
Rated short-time thermal current I _{th} :	< 60I _{pr}	
Rated dynamic current I _{dyn} :	2,5I _{th}	
Instrument security factor (FS):	≤ 5	
Rated secondary current I _s :	5 - 1A	
Max. power dissipation	≤ 23W	≤ 23W
Allowed max cable or busbar temperature:	125°C	
INSULATION REQUIREMENTS		
Type	Dry transformer, air insulation	
Highest voltage for equipment U _m :	0.72kV r.m.s.	
Rated insulation level:	3kV r.m.s. 50Hz/1min	
Class of insulation (EN/IEC 61869-1, 61869-2):	B	
ENVIRONMENTAL CONDITIONS		
Nominal temperature range:	-25...50°C	
Limit temperature range for storage:	-40...85°C	
Relative humidity:	≤ 85%	
Suitable for tropical climates	yes	
CONNECTION		
Primary winding:	Passing bus bar	
Secondary winding:	tightening by nut M4	
MECHANICAL FEATURES		
Housing material:	self extinguishing polycarbonate	
Protection degree (EN/IEC 60529):	P40 housing - IP00 terminals (IP20 with sealable terminal cover)	
Mounting:	screw type on bar	
Weight:	1500 gr	1300 gr

Wiring diagrams

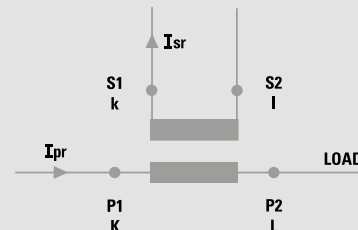

Dimensions

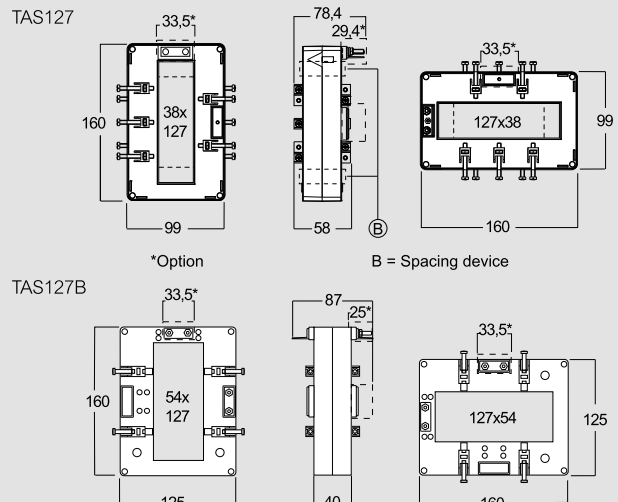

Current transformers - MEASURE

Cable/passing bar single-phase current transformer



TAU9



TAU10



TAU11



TAU12



TAU13

Cat. Nos.	
Isr 5A	Isr 1A
TAUB50D150	TAUB10D150
TAUB50D200	TAUB10D200
TAUB50D250	TAUB10D250
TAUB50D300	TAUB10D300
TAUB50D400	TAUB10D400
TAUB50D500	TAUB10D500

TAU9

Cat. Nos.		Primary current (A)	Accuracy class VA cl. 0.5
Passing cable window/bar 55x165mm			
Isr 5A	Isr 1A	1500A	20
Isr 5A	Isr 1A	2000A	30
Isr 5A	Isr 1A	2500A	40
Isr 5A	Isr 1A	3000A	40
Isr 5A	Isr 1A	4000A	50
Isr 5A	Isr 1A	5000A	60

Cat. Nos.	
Isr 5A	Isr 1A
TAUE50D250	TAUE10D250
TAUE50D300	TAUE10D300
TAUE50D400	TAUE10D400
TAUE50D500	TAUE10D500
TAUE50D600	TAUE10D600
TAUE50D800	TAUE10D800

TAU12

Cat. Nos.		Primary current (A)	Accuracy class VA cl. 0.5
Passing cable window/bar 55x225mm			
Isr 5A	Isr 1A	2500A	40
Isr 5A	Isr 1A	3000A	40
Isr 5A	Isr 1A	4000A	50
Isr 5A	Isr 1A	5000A	60
Isr 5A	Isr 1A	6000A	70
Isr 5A	Isr 1A	8000A	70

Cat. Nos.	
Isr 5A	Isr 1A
TAUC50D150	TAUC10D150
TAUC50D200	TAUC10D200
TAUC50D250	TAUC10D250
TAUC50D300	TAUC10D300
TAUC50D400	TAUC10D400
TAUC50D500	TAUC10D500
TAUC50D600	TAUC10D600

TAU10

Cat. Nos.		Primary current (A)	Accuracy class VA cl. 0.5
Passing cable window/bar 120x125mm			
Isr 5A	Isr 1A	1500A	20
Isr 5A	Isr 1A	2000A	30
Isr 5A	Isr 1A	2500A	40
Isr 5A	Isr 1A	3000A	40
Isr 5A	Isr 1A	4000A	50
Isr 5A	Isr 1A	5000A	60
Isr 5A	Isr 1A	6000A	70

Cat. Nos.	
Isr 5A	Isr 1A
TAUF50D250	TAUF10D250
TAUF50D300	TAUF10D300
TAUF50D400	TAUF10D400
TAUF50D500	TAUF10D500
TAUF50D600	TAUF10D600
TAUF50D800	TAUF10D800

TAU13

Cat. Nos.		Primary current (A)	Accuracy class VA cl. 0.5
Passing cable window/bar 120x225mm			
Isr 5A	Isr 1A	2500A	40
Isr 5A	Isr 1A	3000A	40
Isr 5A	Isr 1A	4000A	50
Isr 5A	Isr 1A	5000A	60
Isr 5A	Isr 1A	6000A	70
Isr 5A	Isr 1A	8000A	70

Cat. Nos.	
Isr 5A	Isr 1A
TAUD50D150	TAUD10D150
TAUD50D200	TAUD10D200
TAUD50D250	TAUD10D250
TAUD50D300	TAUD10D300
TAUD50D400	TAUD10D400
TAUD50D500	TAUD10D500
TAUD50D600	TAUD10D600
TAUD50D800	TAUD10D800

TAU11

Cat. Nos.		Primary current (A)	Accuracy class VA cl. 0.5
Passing cable window/bar 120x165mm			
Isr 5A	Isr 1A	1500A	20
Isr 5A	Isr 1A	2000A	30
Isr 5A	Isr 1A	2500A	40
Isr 5A	Isr 1A	3000A	40
Isr 5A	Isr 1A	4000A	50
Isr 5A	Isr 1A	5000A	60
Isr 5A	Isr 1A	6000A	70
Isr 5A	Isr 1A	8000A	70

Cat. Nos.
ATACOP05

Accessories

Description
Accessory sealable terminal cover

Current transformers - MEASURE

Cable/passing bar single-phase current transformer

Technical features

MODEL	TAU9	TAU10	TAU11	TAU12	TAU13
TECHNICAL NOTES	NT520	NT717	NT719	NT819	NT820
SPECIFICATIONS					
Reference specification	EN/IEC 61869-1, 61869-2				
Rated primary current I _{pr} :	1500...5000A	1500...6000A	1500...8000A	2500...8000A	2500...8000A
Rated frequency:	50Hz				
Working frequency:	47...63Hz				
Rated continuous thermal current I _{cth} :	100% I _{pr}				
Rated short-time thermal current I _{th} :	< 60I _{pr}				
Rated dynamic current I _{dyn} :	2,5I _{th}				
Instrument security factor (FS):	≤ 5				
Rated secondary current I _{sr} :	5 - 1A				
Max. power dissipation	≤ 43W	≤ 43W	≤ 81W	≤ 75W	≤ 70W
Allowed max cable or busbar temperature:	125°C				
INSULATION REQUIREMENTS					
Type	Dry transformer, air insulation				
Highest voltage for equipment U _m :	0.72kV r.m.s.				
Rated insulation level:	3kV r.m.s. 50Hz/1min				
Class of insulation (EN/IEC 61869-1, 61869-2):	B				
ENVIRONMENTAL CONDITIONS					
Nominal temperature range:	-25...50°C				
Limit temperature range for storage:	-40...85°C				
Relative humidity:	≤ 85%				
Suitable for tropical climates	yes				
CONNECTION					
Primary winding:	Passing bus bar				
Secondary winding	tightening by nut M5				
MECHANICAL FEATURES					
Housing material:	self extinguishing polycarbonate				
Protection degree (EN/IEC 60529):	IP20 housing, IP00 terminals (IP20 with sealable terminal cover)				
Mounting:	screw type on bar				
Weight:	5000 gr	5700 gr	6700 gr	5000 gr	5000 gr

Wiring diagrams

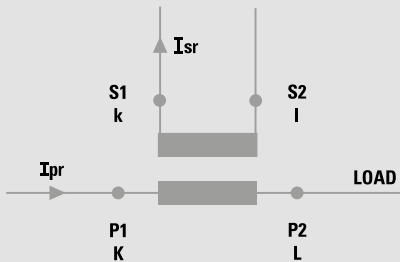

Dimensions

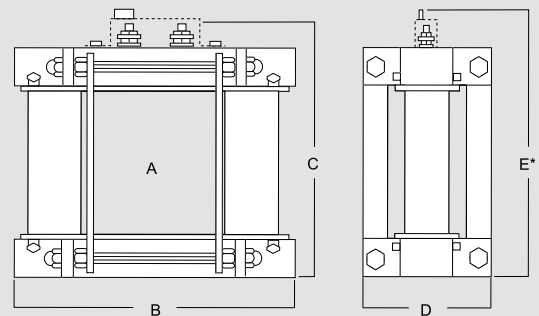

* option

Dim. (mm)	A	B	C	D	E
TAU9	55x165	177	261	110	273.5
TAU10	120x125	257	221	110	233.5
TAU11	120x165	257	261	110	273.5
TAU12	55x225	177	321	110	333.5
TAU13	120x225	257	321	110	333.5

Current transformers - MEASURE

Current summation transformer



BAS02



BAS03

Cat. Nos.		BSA02			
2 single-phase input current summation transformer It effects the vectorial sum of the currents of many lines in just one voltage system. It is essential when the main C.T. ratios are not the same Primary winding					
Isr 5A	Isr 1A	Primary current (A)	Accuracy class VA cl. 0.5	Accuracy class VA cl. 1	
TAEA5025		5+5A	10	15	
	TAEA1021	1+1A	10	15	

Cat. Nos.		BSA03			
3 single-phase input current summation transformer					
Isr 5A	Isr 1A	Primary current (A)	Accuracy class VA cl. 0.5	Accuracy class VA cl. 1	
TAEA5035		5+5+5A	10	15	
	TAEA1031	1+1+1A	10	15	

Cat. Nos.		Accessories	
Description			
ATACOP11	Accessory sealable terminal cover		



BTA2

Cat. Nos.		BTA2	
From 2 to 6 single-phase input current summation transformer It effects the vectorial sum of the currents of many lines in just one voltage system. It is essential when the main C.T. ratios are not the same Primary currents 1...5A Accuracy: class 0,5 Rated burden: 40VA (2...4 input) - 15VA (5...6 input)			
Isr 5A	Isr 1A	Primary current (A)	Accuracy class VA cl. 0.5
TAEB5025		5+5A	40
TAEB5035		5+5+5A	40
TAEB5045		5+5+5+5A	40
TAEB5055		5+5+5+5+5A	15
TAEB5065		5+5+5+5+5+5A	15
	TAEB1021	1+1A	40
	TAEB1031	1+1+1A	40
	TAEB1041	1+1+1+1A	40
	TAEB1051	1+1+1+1+1A	15
	TAEB1061	1+1+1+1+1+1A	15

Technical features

MODEL	BSA02 - BSA03	BTA2
TECHNICAL NOTES	NT731	NT732
SPECIFICATIONS		
Reference specification	EN/IEC 61869-1, 61869-2	
Rated primary current I _{pr} :	1...5A	1...5A
Rated frequency:	50Hz	
Working frequency:	47...63Hz	
Input number:	2 (BSA02) or 3 (BS03)	2-3
Rated continuous thermal current I _{cth} :	100% I _{pr}	
Rated short-time thermal current I _{th} :	< 60I _{pr} (max.90kA/1s)	
Rated dynamic current I _{dyn} :	2,5I _{th}	
Instrument security factor (FS):	≤ 15	
Rated secondary current I _{sr} :	1-5A	
Allowed max cable or busbar temperature:	125°C	
INSULATION REQUIREMENTS		
Type	Dry transformer, air insulation	
Highest voltage for equipment U _m :	0.72kV r.m.s.	
Rated insulation level:	3kV r.m.s. 50Hz/1min between primary and secondary terminals, 500V r.m.s. 50Hz/1min between primary sections	
Class of insulation (EN/IEC 61869-1, 61869-2):	B	
ENVIRONMENTAL CONDITIONS		
Nominal temperature range:	-25...50°C	
Limit temperature range for storage:	-40...85°C	
Relative humidity:	≤ 85%	
Suitable for tropical climates	yes	
CONNECTION		
Primary winding:	tightening by nut M4	
Secondary winding	tightening by nut M4	
MECHANICAL FEATURES		
Housing material:	self extinguishing polycarbonate	metal
Protection degree (EN/IEC 60529):	P40 housing - IP00 terminals (IP20 with sealable terminal cover)	self extinguishing polycarbonate
Mounting:	top hat TH35-15 (EN/IEC 60715)	screw type for wall mounting
Weight:	320 gr	4000 gr

Wiring diagrams

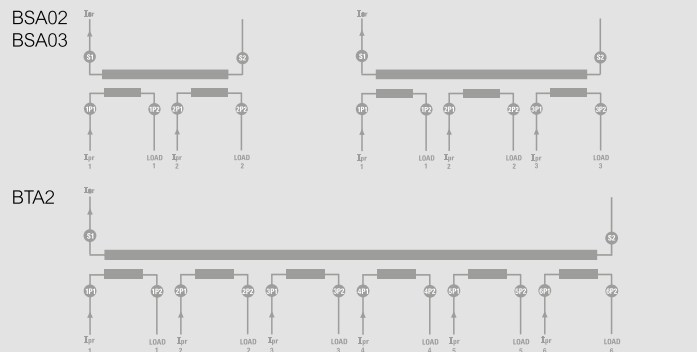

Dimensions

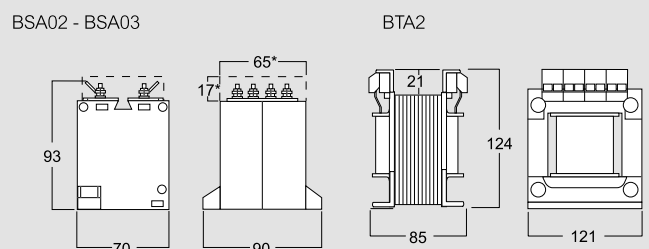

Current transformers - ACCURACY

Winding primary single-phase current transformer



TAQ6L



TAQ6M



TAQ10

Cat. Nos.		TAQ6M	
Isr 5A	Isr 1A	Primary current (A)	Accuracy class VA
			cl. 0.2 cl. 0.5s
TAQ6M50A500S	TAQ6M10A500S	5A	3 5
TAQ6M50B100S	TAQ6M10B100S	10A	3 5
TAQ6M50B150S	TAQ6M10B150S	15A	3 5
TAQ6M50B200S	TAQ6M10B200S	20A	3 5
TAQ6M50B250S	TAQ6M10B250S	25A	3 5
TAQ6M50B300S	TAQ6M10B300S	30A	3 5
TAQ6M50B400S	TAQ6M10B400S	40A	3 5

Cat. Nos.		TAQ6L	
Isr 5A	Isr 1A	Primary current (A)	Accuracy class VA
			cl. 0.2 cl. 0.5s
TAQ6L50B500S	TAQ6L10B500S	50A	3 5
TAQ6L50B600S	TAQ6L10B600S	60A	3 5
TAQ6L50B750S	TAQ6L10B750S	75A	3 5
TAQ6L50B800S	TAQ6L10B800S	80A	3 5

Cat. Nos.		TAQ10	
Isr 5A	Isr 1A	Primary current (A)	Accuracy class VA
			cl. 0.2 cl. 0.5s
TAQC50A500S	TAQC10A500S	5A	5 10
TAQC50B100S	TAQC10B100S	10A	5 10
TAQC50B150S	TAQC10B150S	15A	5 10
TAQC50B200S	TAQC10B200S	20A	5 10
TAQC50B250S	TAQC10B250S	25A	5 10
TAQC50B300S	TAQC10B300S	30A	5 10
TAQC50B400S	TAQC10B400S	40A	5 10
TAQC50B500S	TAQC10B500S	50A	5 10
TAQC50B600S	TAQC10B600S	60A	5 10
TAQC50B700S	TAQC10B700S	70A	5 10
TAQC50B750S	TAQC10B750S	75A	5 10
TAQC50B800S	TAQC10B800S	80A	5 10
TAQC50C100S	TAQC10C100S	100A	5 10
TAQC50C120S	TAQC10C120S	120A	5 10
TAQC50C150S	TAQC10C150S	150A	5 10

Cat. Nos.	Accessories
ATACOP03	Description Accessory sealable terminal cover for TAQ10

Wiring diagrams

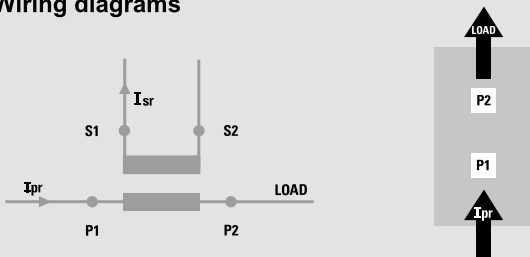

Technical features

MODEL	TAQ6M	TAQ6L	TAQ10
TECHNICAL NOTES	NT885	NT886	NT826
SPECIFICATIONS			
Reference specification		EN/IEC 61869-1, 61869-2	
Rated primary current I _{pr} :	5...40A	50...80A	5...300A
Rated frequency:	50Hz		
Working frequency:	47...63Hz		
Rated continuous thermal current I _{cth} :	100% I _{pr}		
Rated short-time thermal current I _{th} :	< 60I _{pr}		
Rated dynamic current I _{dyn} :	2,5I _{th}		
Instrument security factor (FS):	≤ 5		
Rated secondary current I _{sr} :	5 - 1A		
Max. power dissipation	≤ 4.3W	≤ 4.3W	≤ 2.5W
Allowed max cable or busbar temp.:	125°C		

INSULATION REQUIREMENTS	
Type	Dry transformer, air insulation
Highest voltage for equipment U _m :	0.72kV r.m.s.
Rated insulation level:	3kV r.m.s. 50Hz/1min
Class of insulation (EN/IEC 61869-1, 61869-2):	B
ENVIRONMENTAL CONDITIONS	
Nominal temperature range:	-25...50°C
Limit temperature range for storage:	-40...85°C
Relative humidity:	≤ 85%
Suitable for tropical climates	yes

CONNECTION			
Primary winding:	2 screw terminals (max. cable section 6mm ² , 10mm ² cable with lag)	Tightening by nut M6	built-in central bar (25x4mm)
Secondary winding	2 screw terminals (max. cable section 6mm ² , 10mm ² cable with lag)	4 screw terminals (max. cable section 6mm ²) + 2 fast-ons (4,8x0,8mm)	double screw M4

MECHANICAL FEATURES			
Housing material:	self extinguishing polycarbonate		
Protection degree (EN/IEC 60529):	IP40 housing - IP20 terminals	IP20 housing, IP00 terminals	
Mounting:	snap-on 35mm rail, screw type for wall mounting		
Weight:	250 gr	300 gr	700 gr

Dimensions

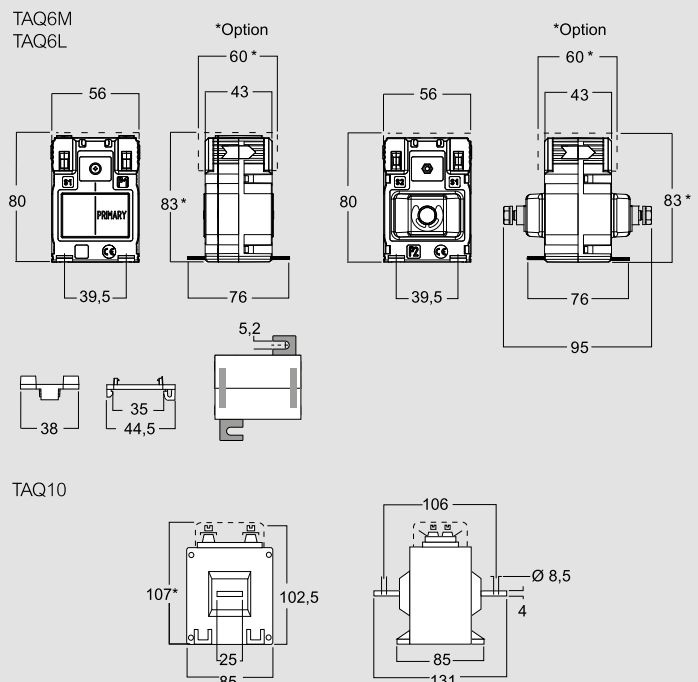

Current transformers - ACCURACY

Cable/passing bar single-phase current transformer



TA327



TA432

Cat. Nos.

TA327

Passing cable window/bar Ø 27mm - 25,5x15,5mm - 32,5x10,5mm

Isr 5A	Isr 1A	Primary current (A)	Accuracy class VA		
			cl. 0.2s	cl. 0.2	cl. 0.5s
TA32750C150S	TA32710C150S	150	1	1.5	2
TA32750C160S	TA32710C160S	160	1	1.5	2
TA32750C200S	TA32710C200S	200	2	2.5	3
TA32750C250S	TA32710C250S	250	2	2.5	3
TA32750C300S	TA32710C300S	300	2.5	4	5
TA32750C400S	TA32710C400S	400	4	5	8
TA32750C500S	TA32710C500S	500	6	7	10
TA32750C600S	TA32710C600S	600	8	10	15

Cat. Nos.

TA432

Passing cable window/bar Ø 32mm - 25,5x25,5mm - 32,5x20,5mm - 40,5x10,5mm

Isr 5A	Isr 1A	Primary current (A)	Accuracy class VA		
			cl. 0.2s	cl. 0.2	cl. 0.5s
TA43250C200S	TA43210C200S	200A	1	1.5	2.5
TA43250C250S	TA43210C250S	250A	1	1.5	2.5
TA43250C300S	TA43210C300S	300A	1.5	2	3
TA43250C400S	TA43210C400S	400A	1.5	3	4
TA43250C500S	TA43210C500S	500A	2.5	5	5
TA43250C600S	TA43210C600S	600A	3	6	7
TA43250C700S	TA43210C700S	700A	4	7	7
TA43250C750S	TA43210C750S	750A	4	7	8
TA43250C800S	TA43210C800S	800A	5	8	10
TA43250D100S	TA43210D100S	1000A	6	10	12

Cat. Nos.

Accessories

Cat. Nos.	Description
ATACOP13	Accessory sealable terminal cover

Wiring diagrams

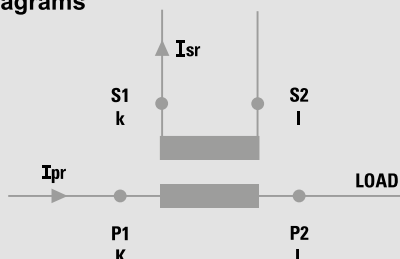

Technical features

MODEL	TA327	TA432
TECHNICAL NOTES	NT812	NT830
SPECIFICATIONS		
Reference specification	EN/IEC 61869-1, 61869-2	
Rated primary current Ipr:	150...600A	200...1000A
Rated frequency:	50Hz	
Working frequency:	47...63Hz	
Rated continuous thermal current Icth:	100% Ipr	
Rated short-time thermal current Ith:	< 60Ipr	
Rated dynamic current Idyn :	2,5Ith	
Instrument security factor (FS):	≤ 5	
Rated secondary current Isr :	5 - 1A	
Max. power dissipation	≤ 7W at Icth	≤ 9W at Icth
Allowed max cable or busbar temperature:	125°C	
INSULATION REQUIREMENTS		
Type	Dry transformer, air insulation	
Highest voltage for equipment Um:	0.72kV r.m.s.	
Rated insulation level:	3kV r.m.s. 50Hz/1min	
Class of insulation (EN/IEC 61869-1, 61869-2):	B	
ENVIRONMENTAL CONDITIONS		
Nominal temperature range:	-25...50°C	
Limit temperature range for storage:	-40...85°C	
Relative humidity:	≤ 85%	
Suitable for tropical climates	yes	
CONNECTION		
Primary winding:	passing cable/bus bar primary	
Secondary winding	4 screw terminals (max. cable section 6mm ²)+ 2 fast-ons (4,8x0,8mm)	
MECHANICAL FEATURES		
Housing material:	self extinguishing polycarbonate	
Protection degree (EN/IEC 60529):	IP40 housing - IP20 terminals	
Mounting:	snap-on 35mm rail, screw type for wall mounting	
Weight:	260 gr	420 gr

Dimensions

TA327

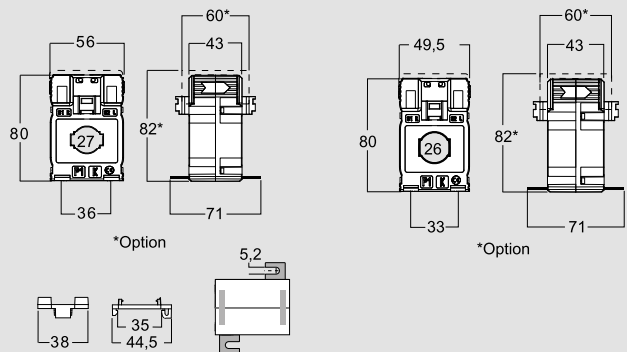

TA432

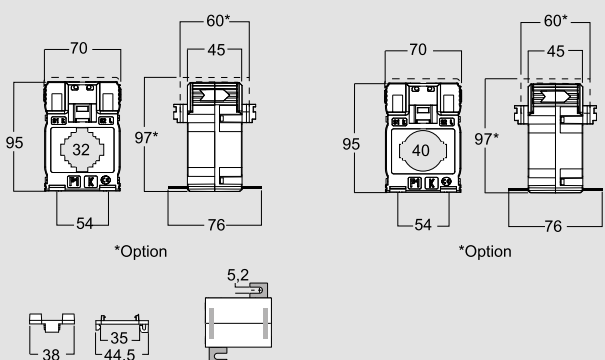

Current transformers - ACCURACY

Cable/passing bar single-phase current transformer



TAS65

TAS84

Cat. Nos.				TAS65			
Bars in VERTICAL		Bars in HORIZONTAL		Primary current (A)	Accuracy class VA		
Isr 5A	Isr 1A	Isr 5A	Isr 1A		cl. 0.2s	cl. 0.2	cl. 0.5s
TASL50C600S	TASL10C600S	TASL50C6003S	TASL10C6003S	600A	1	3	5
TASL50C700S	TASL10C700S	TASL50C7003S	TASL10C7003S	700A	1.5	4	7.5
TASL50C750S	TASL10C750S	TASL50C7503S	TASL10C7503S	750A	2	5	7.5
TASL50C800S	TASL10C800S	TASL50C8003S	TASL10C8003S	800A	2.5	7.5	10
TASL50D100S	TASL10D100S	TASL50D1003S	TASL10D1003S	1000A	10	12	15
TASL50D120S	TASL10D120S	TASL50D1203S	TASL10D1203S	1200A	12	15	20
TASL50D125S	TASL10D125S	TASL50D1253S	TASL10D1253S	1250A	12	15	20
TASL50D150S	TASL10D150S	TASL50D1503S	TASL10D1503S	1500A	12	15	20
TASL50D160S	TASL10D160S	TASL50D1603S	TASL10D1603S	1600A	12	15	20
TASL50D200S	TASL10D200S	TASL50D2003S	TASL10D2003S	2000A	12	15	20

Passing cable window/bar 32x65mm and 65x32mm - long side terminals

Cat. Nos.				TAS84			
Bars in VERTICAL		Bars in HORIZONTAL		Primary current (A)	Accuracy class VA		
Isr 5A	Isr 1A	Isr 5A	Isr 1A		cl. 0.2s	cl. 0.2	cl. 0.5s
TASO50C800S	TASO10C800S	TASO50C8003S	TASO10C8003S	800A	4	6	7
TASO50D100S	TASO10D100S	TASO50D1003S	TASO10D1003S	1000A	6	7	8
TASO50D120S	TASO10D120S	TASO50D1203S	TASO10D1203S	1200A	10	12	14
TASO50D125S	TASO10D125S	TASO50D1253S	TASO10D1253S	1250A	10	12	14
TASO50D150S	TASO10D150S	TASO50D1503S	TASO10D1503S	1500A	15	17.5	20
TASO50D160S	TASO10D160S	TASO50D1603S	TASO10D1603S	1600A	15	17.5	20
TASO50D200S	TASO10D200S	TASO50D2003S	TASO10D2003S	2000A	15	20	25
TASO50D250S	TASO10D250S	TASO50D2503S	TASO10D2503S	2500A	20	25	30

Passing cable window/bar 34x84mm and 84x34mm - long side terminals

Cat. Nos.	Accessories
	Description
ATACOP04	Accessory sealable terminal cover
ATADIS01	Spacing device for bars of 60 mm (for TAS84)
ATADIS03	Spacing device for bars of 50 mm (for TAS65)
ATAFIS01	2 metallic feet for wall mounting (for TAS65)

Technical features

MODEL	TAS65	TAS84
TECHNICAL NOTES	NT831	NT832
SPECIFICATIONS		
Reference specification	EN/IEC 61869-1, 61869-2	
Rated primary current I _{pr} :	600...2000A	800...2500A
Rated frequency:	50Hz	
Working frequency:	47...63Hz	
Rated continuous thermal current I _{cth} :	100% I _{pr}	
Rated short-time thermal current I _{th} :	< 60I _{pr}	
Rated dynamic current I _{dyn} :	2,5I _{th}	
Instrument security factor (FS):	≤ 5	
Rated secondary current I _s :	5 - 1A	
Max. power dissipation	≤ 20W	≤ 19W
Allowed max cable or busbar temperature:	125°C	
INSULATION REQUIREMENTS		
Type	Dry transformer, air insulation	
Highest voltage for equipment U _m :	0.72kV r.m.s.	
Rated insulation level:	3kV r.m.s. 50Hz/1min	
Class of insulation (EN/IEC 61869-1, 61869-2):	B	
ENVIRONMENTAL CONDITIONS		
Nominal temperature range:	-25...50°C	
Limit temperature range for storage:	-40...85°C	
Relative humidity:	≤ 85%	
Suitable for tropical climates	yes	
CONNECTION		
Primary winding:	Passing bus bar	
Secondary winding	tightening by nut M4	
MECHANICAL FEATURES		
Housing material:	self extinguishing polycarbonate	
Protection degree (EN/IEC 60529):	P40 housing - IP00 terminals (IP20 with sealable terminal cover)	
Mounting:	screw type on bar	
Weight:	750 gr	750 gr

Dimensions

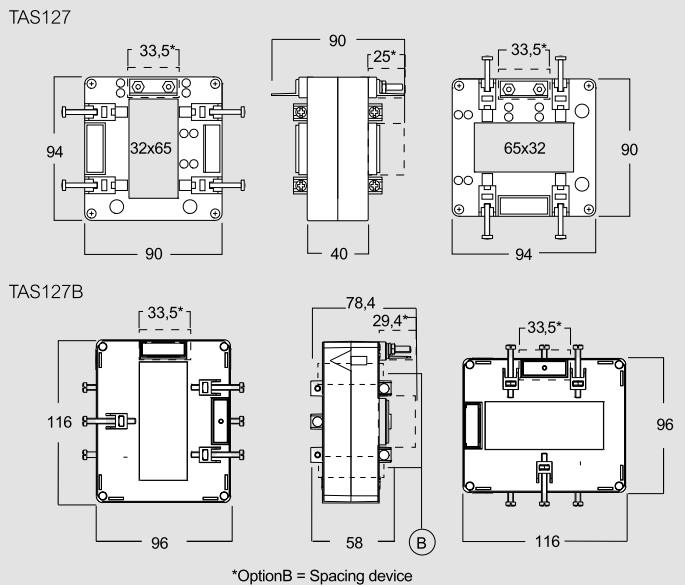

Wiring diagrams

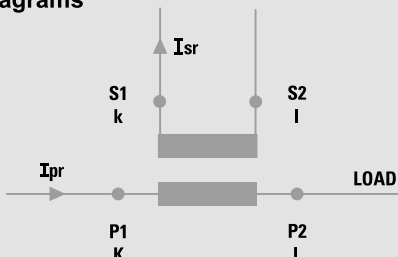

Current transformers - ACCURACY

Cable/passing bar single-phase current transformer



TAS102

Cat. Nos.

TAS102

FIXING ON VERTICAL BARS
Single-phase current transformer
Passing cable window/bar 38x102mm and
102x38mm - long side terminals

Isr 5A	Isr 1A	Primary current (A)	Accuracy class VA		
			cl. 0.2s	cl. 0.2	cl. 0.5s
TAMP50D100S	TAMP10D100S	1000A	5	7.5	10
TAMP50D120S	TAMP10D120S	1200A	5	7.5	10
TAMP50D125S	TAMP10D125S	1250A	5	7.5	10
TAMP50D150S	TAMP10D150S	1500A	7.5	10	15
TAMP50D160S	TAMP10D160S	1600A	7.5	10	15
TAMP50D200S	TAMP10D200S	2000A	10	15	20
TAMP50D250S	TAMP10D250S	2500A	15	20	25
TAMP50D300S	TAMP10D300S	3000A	20	25	30

Cat. Nos.

TAS102

FIXING ON HORIZONTAL BARS
(terminals on long side)
Single-phase current transformer
Passing cable window/bar 38x102mm and
102x38mm - long side terminals

Isr 5A	Isr 1A	Primary current (A)	Accuracy class VA		
			cl. 0.2s	cl. 0.2	cl. 0.5s
TAMP50D1003S	TAMP10D1003S	1000A	5	7.5	10
TAMP50D1203S	TAMP10D1203S	1200A	5	7.5	10
TAMP50D1253S	TAMP10D1253S	1250A	5	7.5	10
TAMP50D1503S	TAMP10D1503S	1500A	7.5	10	15
TAMP50D1603S	TAMP10D1603S	1600A	7.5	10	15
TAMP50D2003S	TAMP10D2003S	2000A	10	15	20
TAMP50D2503S	TAMP10D2503S	2500A	15	20	25
TAMP50D3003S	TAMP10D3003S	3000A	20	25	30

Cat. Nos.

Accessories

Cat. Nos.	Description
ATACOP04	Accessory sealable terminal cover
ATAFIS01	Screw type for wall mounting

Technical features

MODEL	TAS102
TECHNICAL NOTES	NT833
SPECIFICATIONS	
Reference specification	EN/IEC 61869-1, 61869-2
Rated primary current I _{pr} :	1000...3000A
Rated frequency:	50Hz
Working frequency:	47...63Hz
Rated continuous thermal current I _{cth} :	100% I _{pr}
Rated short-time thermal current I _{th} :	< 60I _{pr}
Rated dynamic current I _{dyn} :	2,5I _{th}
Instrument security factor (FS):	≤ 5
Rated secondary current I _s :	1 - 5A
Max. power dissipation	≤ 25W
The allowed max cable or busbar temp is:	125°C
INSULATION REQUIREMENTS	
Type	Dry transformer, air insulation
Highest voltage for equipment U _m :	0.72kV r.m.s.
Rated insulation level:	3kV r.m.s. 50Hz/1min
Class of insulation (EN/IEC 61869-1, 61869-2):	B
ENVIRONMENTAL CONDITIONS	
Nominal temperature range:	-25...50°C
Limit temperature range for storage:	-40...85°C
Relative humidity:	≤ 85%
Suitable for tropical climates	yes
CONNECTION	
Primary winding:	Passing bus bar
Secondary winding	tightening by nut M4
MECHANICAL FEATURES	
Housing material:	self extinguishing polycarbonate
Protection degree (EN/IEC 60529):	P40 housing - IP00 terminals (IP20 with sealable terminal cover)
Mounting:	screw type on bar
Weight:	1000 gr

Wiring diagrams

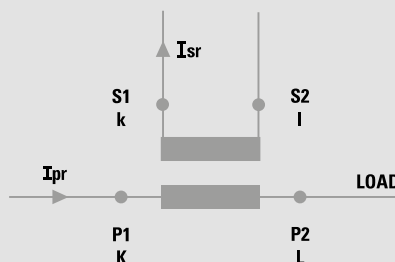

Dimensions

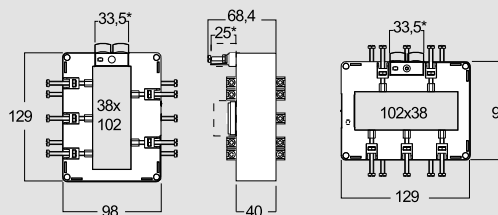

Current transformers - ACCURACY

Cable/passing bar single-phase current transformer

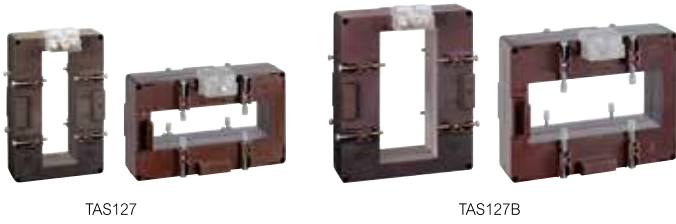

TAS127

TAS127B

Cat. Nos.			
Bars in VERTICAL		Bars in HORIZONTAL	
I _{sr} 5A	I _{sr} 1A	I _{sr} 5A	I _{sr} 1A
TASR50D100S	TASR10D100S	TASR50D1003S	TASR10D1003S
TASR50D120S	TASR10D120S	TASR50D1203S	TASR10D1203S
TASR50D125S	TASR10D125S	TASR50D1253S	TASR10D1253S
TASR50D150S	TASR10D150S	TASR50D1503S	TASR10D1503S
TASR50D160S	TASR10D160S	TASR50D1603S	TASR10D1603S
TASR50D200S	TASR10D200S	TASR50D2003S	TASR10D2003S
TASR50D250S	TASR10D250S	TASR50D2503S	TASR10D2503S
TASR50D300S	TASR10D300S	TASR50D3003S	TASR10D3003S

TAS127

Passing cable window/bar 38x127mm and 127x38mm - long side terminals

Primary current (A)	Accuracy class VA		
	cl. 0.2s	cl. 0.2	cl. 0.5s
	1000A	4	6
1200A	5	7.5	10
1250A	5	7.5	10
1500A	7.5	10	12.5
1600A	7.5	10	12.5
2000A	10	15	20
2500A	15	20	25
3000A	20	25	30

Cat. Nos.			
Bars in VERTICAL		Bars in HORIZONTAL	
I _{sr} 5A	I _{sr} 1A	I _{sr} 5A	I _{sr} 1A
TASS50D150S	TASS10D150S	TASS50D1503S	TASS10D1503S
TASS50D160S	TASS10D160S	TASS50D1603S	TASS10D1603S
TASS50D200S	TASS10D200S	TASS50D2003S	TASS10D2003S
TASS50D250S	TASS10D250S	TASS50D2503S	TASS10D2503S
TASS50D300S	TASS10D300S	TASS50D3003S	TASS10D3003S
TASS50D320S	TASS10D320S	TASS50D3203S	TASS10D3203S
TASS50D400S	TASS10D400S	TASS50D4003S	TASS10D4003S

TAS127B

Passing cable window/bar 38x127mm and 127x38mm - long side terminals

Primary current (A)	Accuracy class VA		
	cl. 0.2s	cl. 0.2	cl. 0.5s
	1500A	7.5	10
1600A	7.5	10	12.5
2000A	10	12.5	15
2500A	12.5	15	20
3000A	15	20	25
3200A	15	20	25
4000A	20	25	30

Cat. Nos.	Accessories
	Description
ATACOP04	Accessory sealable terminal cover
ATADIS02	Spacing device for bars of 100 mm

Technical features

MODEL	TAS127	TAS127B
TECHNICAL NOTES	NT834	NT835
SPECIFICATIONS		
Reference specification	EN/IEC 61869-1, 61869-2	
Rated primary current I _{pr} :	1000...3000A	1500...4000A
Rated frequency:	50Hz	
Working frequency:	47...63Hz	
Rated continuous thermal current I _{cth} :	100% I _{pr}	
Rated short-time thermal current I _{th} :	< 60I _{pr}	
Rated dynamic current I _{dyn} :	2,5I _{th}	
Instrument security factor (FS):	≤ 5	
Rated secondary current I _{sr} :	5 - 1A	
Max. power dissipation	≤ 23W	≤ 23W
Allowed max cable or busbar temperature:	125°C	
INSULATION REQUIREMENTS		
Type	Dry transformer, air insulation	
Highest voltage for equipment U _m :	0.72kV r.m.s.	
Rated insulation level:	3kV r.m.s. 50Hz/1min	
Class of insulation (EN/IEC 61869-1, 61869-2):	B	
ENVIRONMENTAL CONDITIONS		
Nominal temperature range:	-25...50°C	
Limit temperature range for storage:	-40...85°C	
Relative humidity:	≤ 85%	
Suitable for tropical climates	yes	
CONNECTION		
Primary winding:	Passing bus bar	
Secondary winding	tightening by nut M4	
MECHANICAL FEATURES		
Housing material:	self extinguishing polycarbonate	
Protection degree (EN/IEC 60529):	P40 housing - IP00 terminals (IP20 with sealable terminal cover)	
Mounting:	screw type on bar	
Weight:	1500 gr	1300 gr

Wiring diagrams

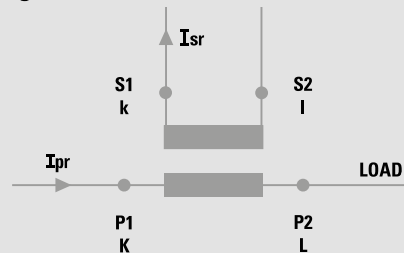

Dimensions

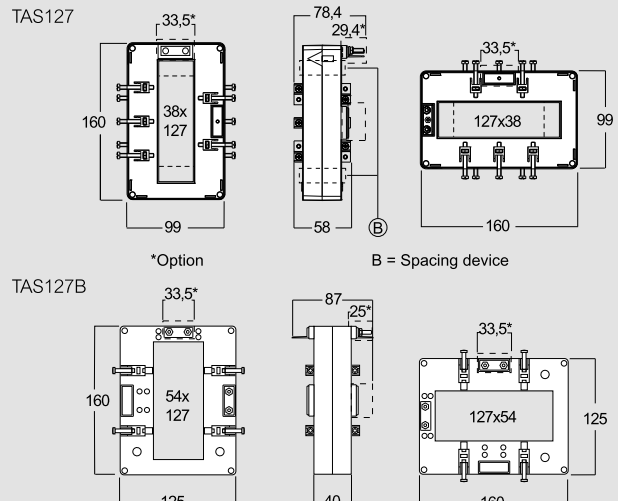

Current transformers - PROTECTION

Winding primary single-phase current transformer



TAQ10P



TAQ20P

Cat. Nos.

TAQ10P

Wound primary with built-in central bar 25x4mm

Isr 5A	Isr 1A	Primary current (A)	Accuracy class VA	
			cl. 5P5	cl. 5P10
TAVB50A500	TAVB10A500	5A	4	2
TAVB50B100	TAVB10B100	10A	4	2
TAVB50B150	TAVB10B150	15A	4	2
TAVB50B200	TAVB10B200	20A	4	2
TAVB50B250	TAVB10B250	25A	4	2
TAVB50B300	TAVB10B300	30A	4	2
TAVB50B400	TAVB10B400	40A	4	2
TAVB50B500	TAVB10B500	50A	4	2
TAVB50B600	TAVB10B600	60A	4	2
TAVB50B700	TAVB10B700	70A	4	2
TAVB50B750	TAVB10B750	75A	4	2
TAVB50B800	TAVB10B800	80A	4	2
TAVB50C100	TAVB10C100	100A	4	2
TAVB50C120	TAVB10C120	120A	4	2
TAVB50C150	TAVB10C150	150A	3	1.5
TAVB50C200	TAVB10C200	200A	4	2
TAVB50C250	TAVB10C250	250A	4	2
TAVB50C300	TAVB10C300	300A	4	2

Cat. Nos.

TAQ20P

Wound primary with built-in central bar 40x4mm

Isr 5A	Isr 1A	Primary current (A)	Accuracy class VA	
			cl. 5P5	cl. 5P10
TAVA50A500	TAVA10A500	5A	8	4
TAVA50B100	TAVA10B100	10A	8	4
TAVA50B150	TAVA10B150	15A	8	4
TAVA50B200	TAVA10B200	20A	8	4
TAVA50B250	TAVA10B250	25A	8	4
TAVA50B300	TAVA10B300	30A	8	4
TAVA50B400	TAVA10B400	40A	8	4
TAVA50B500	TAVA10B500	50A	8	4
TAVA50B600	TAVA10B600	60A	8	4
TAVA50B700	TAVA10B700	70A	8	4
TAVA50B750	TAVA10B750	75A	8	4
TAVA50B800	TAVA10B800	80A	8	4
TAVA50C100	TAVA10C100	100A	8	4
TAVA50C120	TAVA10C120	120A	8	4
TAVA50C150	TAVA10C150	150A	8	4
TAVA50C200	TAVA10C200	200A	8	4
TAVA50C250	TAVA10C250	250A	8	4
TAVA50C300	TAVA10C300	300A	8	4
TAVA50C400	TAVA10C400	400A	8	4
TAVA50C500	TAVA10C500	500A	8	4
TAVA50C600	TAVA10C600	600A	8	4

Cat. Nos.

Accessories

Cat. Nos.	Description
ATACOP03	Accessory sealable terminal cover (for TAQ10P)
ATACOP07	Accessory sealable terminal cover (for TAQ20P)

Technical features

MODEL	TAQ10P	TAQ20P
TECHNICAL NOTES	NT823	NT730
SPECIFICATIONS		
Reference specification	EN 60044-1	
Rated primary current I _{pr} :	5...300A	5...600A
Rated frequency:	50Hz	
Working frequency:	47...63Hz	
Rated continuous thermal current I _{cth} :	100% I _{pr}	
Rated short-time thermal current I _{th} :	< 60I _{pr}	
Rated dynamic current I _{dyn} :	2,5I _{th}	
Rated secondary current I _{sr} :	1 - 5A	
Max. power dissipation	≤ 2.5W	≤ 1.5W
The allowed max cable or busbar temperature is:	125°C	
INSULATION REQUIREMENTS		
Type	Dry transformer, air insulation	
Highest voltage for equipment U _m :	0.72kV r.m.s.	
Rated insulation level:	3kV r.m.s. 50Hz/1min	
Class of insulation (EN 60044-1):	B	
ENVIRONMENTAL CONDITIONS		
Nominal temperature range:	-25...50°C	
Limit temperature range for storage:	-40...85°C	
Relative humidity:	≤ 85%	
Suitable for tropical climates	yes	
CONNECTION		
Primary winding:	built-in central bar (25x4mm)	built-in central bar (40x4mm)
Secondary winding	double screw M4	
MECHANICAL FEATURES		
Housing material:	self extinguishing polycarbonate	
Protection degree (EN/IEC 60529):	P40 housing - IP00 terminals (IP20 with sealable terminal cover)	
Mounting:	screw type on bar	
Weight:	700 gr	2000 gr

Wiring diagrams

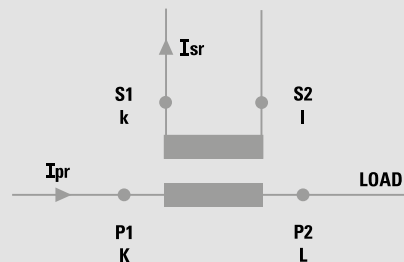

Dimensions

TAQ10P

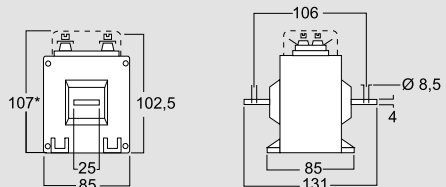

TAQ20P

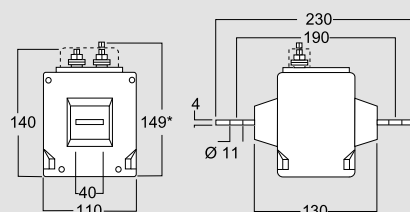

Current transformers - PROTECTION

Cable/passing bar single-phase current transformer

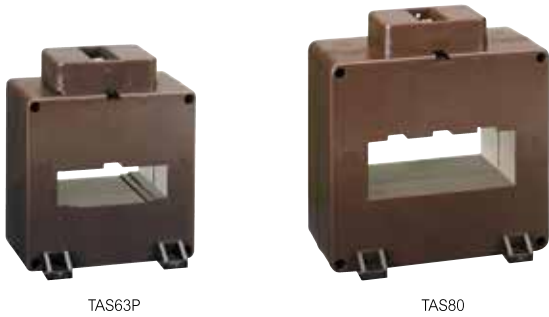

TAS63P

TAS80

Cat. Nos.

TAS63P

Passing cable window/bar 41x21mm - 51x20mm - 64x19mm

Isr 5A	Isr 1A	Primary current (A)	Accuracy class VA	
			cl. 5P5	cl. 5P10
TAWA50C250	TAWA10C250	250A	2.5	1
TAWA50C300	TAWA10C300	300A	3.5	1.2
TAWA50C320	TAWA10C320	320A	4	1.5
TAWA50C400	TAWA10C400	400A	5	1.5
TAWA50C600	TAWA10C600	600A	6	2
TAWA50C700	TAWA10C700	700A	7	2
TAWA50C750	TAWA10C750	750A	7	2
TAWA50C800	TAWA10C800	800A	7	1.5
TAWA50D100	TAWA10D100	1000A	7	1.5
TAWA50D120	TAWA10D120	1200A	10	1.5
TAWA50D125	TAWA10D125	1250A	10	2
TAWA50D150	TAWA10D150	1500A	10	1.5
TAWA50D160	TAWA10D160	1600A	10	1.5

Cat. Nos.

TAS80

Passing cable window/bar 41x21mm - 51x20mm - 64x19mm

Isr 5A	Isr 1A	Primary current (A)	Accuracy class VA			
			cl. 0.5	cl. 1	cl. 5P5	cl. 5P10
TASM50C250	TASM10C250	250A	-	6	-	-
TASM50C300	TASM10C300	300A	4	8	6	2.5
TASM50C320	TASM10C320	320A	8	16	7	2.5
TASM50C400	TASM10C400	400A	10	20	10	3
TASM50C600	TASM10C600	600A	15	30	10	4
TASM50C700	TASM10C700	700A	20	40	10	4
TASM50C750	TASM10C750	750A	20	40	10	4
TASM50C800	TASM10C800	800A	20	40	10	4
TASM50D100	TASM10D100	1000A	20	40	15	4
TASM50D120	TASM10D120	1200A	25	50	20	5
TASM50D125	TASM10D125	1250A	25	50	20	5
TASM50D150	TASM10D150	1500A	40	80	25	5
TASM50D160	TASM10D160	1600A	40	80	25	5
TASM50D200	TASM10D250	2000A	50	100	30	6
TASM50D250	TASM10D250	2500A	60	120	35	6

Cat. Nos.

Accessories

Description
ATACOP03

Accessory sealable terminal cover

Technical features

MODEL	TAS63P	TAS80
TECHNICAL NOTES	NT645	NT571
SPECIFICATIONS		
Reference specification	EN/IEC 61869-1, 61869-2	
Rated primary current I _{pr} :	250...1600A	300...2500A
Rated frequency:	50Hz	
Working frequency:	47...63Hz	
Rated continuous thermal current I _{cth} :	100% I _{pr}	
Rated short-time thermal current I _{th} :	< 60I _{pr}	
Rated dynamic current I _{dyn} :	2,5I _{th}	
Rated secondary current I _{sr} :	5 - 1A	
Max. power dissipation	≤ 8W	≤ 36W
Allowed max cable or busbar temperature:	125°C	
INSULATION REQUIREMENTS		
Type	Dry transformer, air insulation	
Highest voltage for equipment U _m :	0.72kV r.m.s.	
Rated insulation level:	3kV r.m.s. 50Hz/1min	
Class of insulation (EN/IEC 61869-1, 61869-2):	B	
ENVIRONMENTAL CONDITIONS		
Nominal temperature range:	-25...50°C	
Limit temperature range for storage:	-40...85°C	
Relative humidity:	≤ 85%	
Suitable for tropical climates	yes	
CONNECTION		
Primary winding:	passing bus bar	
Secondary winding	tightening by nut M4	
MECHANICAL FEATURES		
Housing material:	self extinguishing polycarbonate	
Protection degree (EN/IEC 60529):	P40 housing - IP00 terminals (IP20 with sealable terminal cover)	
Weight:	900 gr	1200 gr

Wiring diagrams

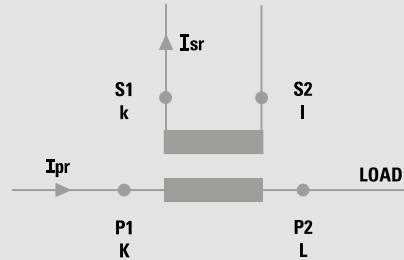

Dimensions

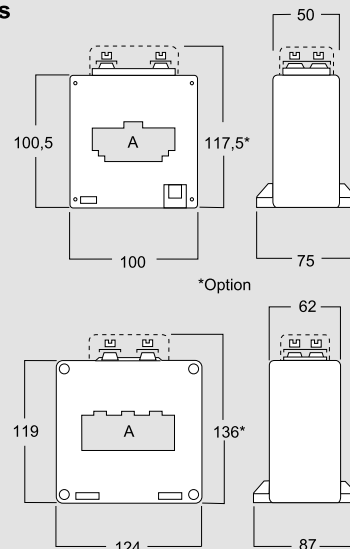

Current transformers - PROTECTION

Cable/passing bar single-phase current transformer



TAS80P

TAS120BP

Cat. Nos.

TAS80P

Passing cable window/bar 82x32mm

Isr 5A	Isr 1A	Primary current (A)	Accuracy class VA			
			cl. 5P5	cl. 5P10	cl. 5P15	cl. 5P20
TAWB50C300	TAWB10C300	300A	8	4	2.5	1.5
TAWB50C320	TAWB10C320	320A	1	5	3	2
TAWB50C400	TAWB10C400	400A	12	6	4	2.5
TAWB50C600	TAWB10C600	600A	15	7	4.5	3
TAWB50C700	TAWB10C700	700A	16	8	4.5	3
TAWB50C750	TAWB10C750	750A	20	9	5	3
TAWB50C800	TAWB10C800	800A	20	8	4.5	2.5
TAWB50D100	TAWB10D100	1000A	25	10	6	3
TAWB50D120	TAWB10D120	1200A	30	12	6	3
TAWB50D125	TAWB10D125	1250A	30	12	6	3
TAWB50D150	TAWB10D150	1500A	35	12	5	-
TAWB50D160	TAWB10D160	1600A	35	12	5	-
TAWB50D200	TAWB10D200	2000A	40	12	3	-
TAWB50D250	TAWB10D250	2500A	45	10	-	-

Cat. Nos.

TAS102BP

Passing cable window/bar 54x102mm

Bars in VERTICAL		Bars in HORIZONTAL		Primary current (A)	Accuracy class VA	
Isr 5A	Isr 1A	Isr 5A	Isr 1A		cl. 5P5	cl. 5P10
TAPQ50C800	TAPQ10C800	TAPQ50C8003	TAPQ10C8003	800A	10	4
TAPQ50D100	TAPQ10D100	TAPQ50D1003	TAPQ10D1003	1000A	12	5
TAPQ50D120	TAPQ10D120	TAPQ50D1203	TAPQ10D1203	1200A	12	5
TAPQ50D125	TAPQ10D125	TAPQ50D1253	TAPQ10D1253	1250A	12	5
TAPQ50D150	TAPQ10D150	TAPQ50D1503	TAPQ10D1503	1500A	15	6
TAPQ50D160	TAPQ10D160	TAPQ50D1603	TAPQ10D1603	1600A	15	6
TAPQ50D200	TAPQ10D200	TAPQ50D2003	TAPQ10D2003	2000A	20	6
TAPQ50D250	TAPQ10D250	TAPQ50D2503	TAPQ10D2503	2500A	20	6
TAPQ50D300	TAPQ10D300	TAPQ50D3003	TAPQ10D3003	3000A	20	4

Cat. Nos.

Accessories

Description
ATACOP03 Accessory sealable terminal cover (for TAS80P)
ATACOP04 Accessory sealable terminal cover (for TAS102BP)
ATAFISO1 Screw type for wall mounting

Wiring diagrams

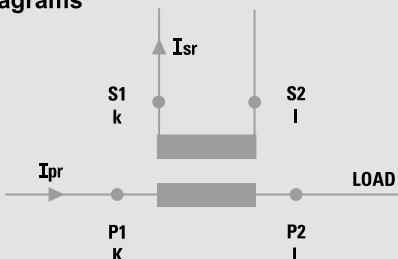

Technical features

MODEL	TAS80P	TAS120BP
TECHNICAL NOTES	NT572	NT768
SPECIFICATIONS		
Reference specification	EN/IEC 61869-1, 61869-2	
Rated primary current Ipr:	300...2500A	800...3000A
Rated frequency:	50Hz	
Working frequency:	47...63Hz	
Rated continuous thermal current Icth:	100% Ipr	
Rated short-time thermal current Ith:	< 60Ipr	
Rated dynamic current Idyn :	2,5Ith	
Rated secondary current Isr :	5 - 1A	
Max. power dissipation	≤ 25.5W	≤ 30W
Allowed max cable or busbar temperature:	125°C	
INSULATION REQUIREMENTS		
Type	Dry transformer, air insulation	
Highest voltage for equipment Um:	0.72kV r.m.s.	
Rated insulation level:	3kV r.m.s. 50Hz/1min	
Class of insulation (EN/IEC 61869-2):	B	
ENVIRONMENTAL CONDITIONS		
Nominal temperature range:	-25...50°C	
Limit temperature range for storage:	-40...85°C	
Relative humidity:	≤ 85%	
Suitable for tropical climates	yes	
CONNECTION		
Primary winding:	passing bus bar	
Secondary winding	tightening by nut M4	
MECHANICAL FEATURES		
Housing material:	self extinguishing polycarbonate	
Protection degree (EN/IEC 60529):	P40 housing - IP00 terminals (IP20 with sealable terminal cover)	
Weight:	2000 gr	2000 gr

Dimensions

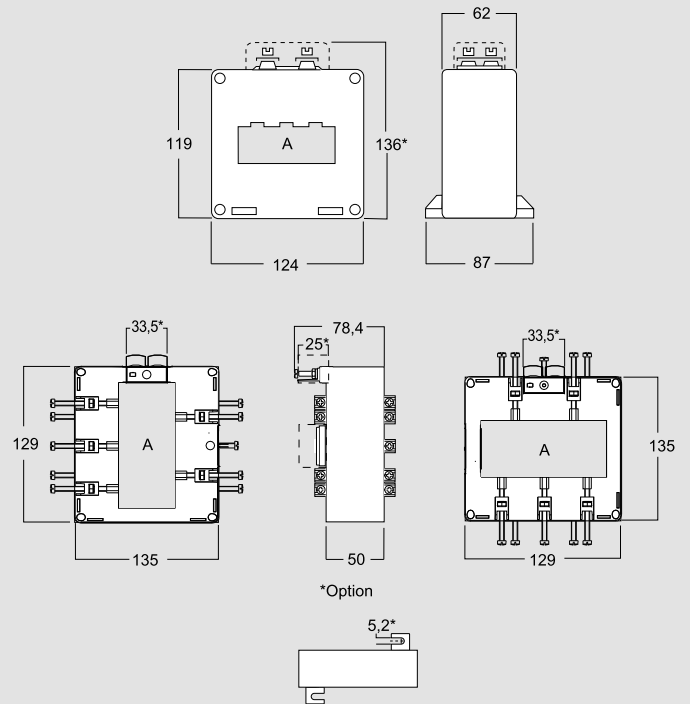

Current transformers - PROTECTION

Cable/passing bar single-phase current transformer



TAS125



TAS125P

Cat. Nos.

TAS125

Passing cable window/bar 127x54mm

Isr 5A	Isr 1A	Primary current (A)	Accuracy class VA	
			cl. 5P5	cl. 5P10
TASQ50C400	TASQ10C400	400A	6	3
TASQ50C500	TASQ10C500	500A	10	3
TASQ50C600	TASQ10C600	600A	10	5
TASQ50C700	TASQ10C700	700A	10	5
TASQ50C750	TASQ10C750	750A	10	5
TASQ50C800	TASQ10C800	800A	15	5
TASQ50D100	TASQ10D100	1000A	15	5
TASQ50D120	TASQ10D120	1200A	20	5
TASQ50D125	TASQ10D125	1250A	20	5
TASQ50D150	TASQ10D150	1500A	20	5
TASQ50D160	TASQ10D160	1600A	20	5
TASQ50D200	TASQ10D200	2000A	25	5
TASQ50D250	TASQ10D250	2500A	30	5
TASQ50D300	TASQ10D300	3000A	40	5
TASQ50D400	TASQ10D400	4000A	50	5

Cat. Nos.

TAS125P

Passing cable window/bar 127x54mm

Isr 5A	Isr 1A	Primary current (A)	Accuracy class VA			
			cl. 5P5	cl. 5P10	cl. 5P15	cl. 5P20
TAWC50C400	TAWC10C400	400A	12	6	3.5	2.5
TAWC50C500	TAWC10C500	500A	15	7	4	3
TAWC50C600	TAWC10C600	600A	20	10	5	4
TAWC50C700	TAWC10C700	700A	20	10	6	4
TAWC50C750	TAWC10C750	750A	25	10	7	5
TAWC50C800	TAWC10C800	800A	25	10	7	5
TAWC50D100	TAWC10D100	1000A	30	15	8	6
TAWC50D120	TAWC10D120	1200A	35	15	8	6
TAWC50D125	TAWC10D125	1250A	35	15	8	6
TAWC50D150	TAWC10D150	1500A	40	20	10	6
TAWC50D160	TAWC10D160	1600A	40	20	10	6
TAWC50D200	TAWC10D200	2000A	50	20	10	4
TAWC50D250	TAWC10D250	2500A	60	20	10	3
TAWC50D300	TAWC10D300	3000A	80	25	10	3
TAWC50D400	TAWC10D400	4000A	100	30	15	3

Cat. Nos.

Accessories

Description
ATACOP03

Accessory sealable terminal cover

Technical features

MODEL	TAS125	TAS125P
TECHNICAL NOTES	NT575	NT576
SPECIFICATIONS		
Reference specification	EN/IEC 61869-1, 61869-2	
Rated primary current I _{pr} :	400...4000A	400...4000A
Rated frequency:	50Hz	
Working frequency:	47...63Hz	
Rated continuous thermal current I _{cth} :	100% I _{pr}	
Rated short-time thermal current I _{th} :	< 60I _{pr}	
Rated dynamic current I _{dyn} :	2,5I _{th}	
Rated secondary current I _{sr} :	5 - 1A	
Max. power dissipation	≤ 44W	≤ 30W
Allowed max cable or busbar temperature:	125°C	
INSULATION REQUIREMENTS		
Type	Dry transformer, air insulation	
Highest max cable for equipment U _m :	0.72kV r.m.s.	
Rated insulation level:	3kV r.m.s. 50Hz/1min	
Class of insulation (EN/IEC 61869-1, 61869-2):	B	
ENVIRONMENTAL CONDITIONS		
Nominal temperature range:	-25...50°C	
Limit temperature range for storage:	-40...85°C	
Relative humidity:	≤ 85%	
Suitable for tropical climates	yes	
CONNECTION		
Primary winding:	passing bus bar	
Secondary winding	tightening by nut M4	
MECHANICAL FEATURES		
Housing material:	self extinguishing polycarbonate	
Protection degree (EN/IEC 60529):	P40 housing - IP00 terminals (IP20 with sealable terminal cover)	
Weight:	1500 gr	3600 gr

Wiring diagrams

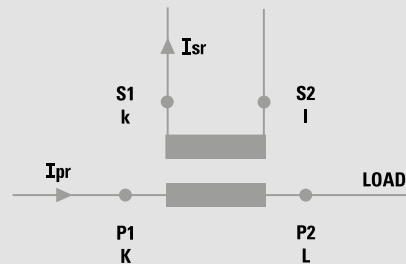

Dimensions

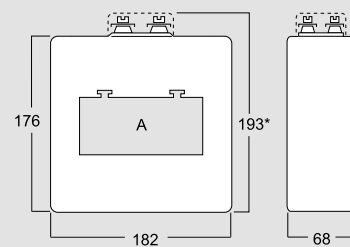

Current transformers - PROTECTION

Cable/passing bar single-phase current transformer



Cat. Nos.		TAU81P					
		Passing cable window/bar 55x125mm					
Isr 5A	Isr 1A	Primary current (A)	Accuracy class VA				
			cl. 5P5	cl. 5P10	cl. 5P15	cl. 5P20	
TAXA50D150	TAXA10D150	1500A	50	15	6	1.5	
TAXA50D200	TAXA10D200	2000A	50	15	6	1.5	
TAXA50D250	TAXA10D250	2500A	80	25	10	1.5	
TAXA50D300	TAXA10D300	3000A	80	35	15	4	
TAXA50D400	TAXA10D400	4000A	100	35	10	-	

Cat. Nos.		TAU91P					
		Passing cable window/bar 55x165mm					
Isr 5A	Isr 1A	Primary current (A)	Accuracy class VA				
			cl. 5P5	cl. 5P10	cl. 5P15	cl. 5P20	
TAXB50D150	TAXB10D150	1500A	50	15	6	2	
TAXB50D200	TAXB10D200	2000A	50	20	10	3	
TAXB50D250	TAXB10D250	2500A	80	25	10	3	
TAXB50D300	TAXB10D300	3000A	80	35	15	4	
TAXB50D400	TAXB10D400	4000A	100	40	15	5	
TAXB50D500	TAXB10D500	5000A	100	40	20	5	

Cat. Nos.		TAU101P					
		Passing cable window/bar 120x125mm					
Isr 5A	Isr 1A	Primary current (A)	Accuracy class VA				
			cl. 5P5	cl. 5P10	cl. 5P15	cl. 5P20	
TAXC50D150	TAXC10D150	1500A	50	15	6	1.5	
TAXC50D200	TAXC10D200	2000A	50	15	6	1.5	
TAXC50D250	TAXC10D250	2500A	80	25	10	1.5	
TAXC50D300	TAXC10D300	3000A	100	35	10	-	
TAXC50D400	TAXC10D400	4000A	100	40	15	-	
TAXC50D500	TAXC10D500	5000A	160	40	8	-	
TAXC50D600	TAXC10D600	6000A	180	50	10	-	

Cat. Nos.		TAU111P					
		Passing cable window/bar 120x165mm					
Isr 5A	Isr 1A	Primary current (A)	Accuracy class VA				
			cl. 5P5	cl. 5P10	cl. 5P15	cl. 5P20	
TAXD50D150	TAXD10D150	1500A	50	15	6	2	
TAXD50D200	TAXD10D200	2000A	50	20	10	3	
TAXD50D250	TAXD10D250	2500A	80	25	10	3	
TAXD50D300	TAXD10D300	3000A	80	35	15	4	
TAXD50D400	TAXD10D400	4000A	100	40	15	5	
TAXD50D500	TAXD10D500	5000A	100	40	20	5	
TAXD50D600	TAXD10D600	6000A	100	40	20	3	
TAXD50D800	TAXD10D800	8000A	100	40	20	-	

Cat. Nos.		TAU121P					
		Passing cable window/bar 55x225mm					
Isr 5A	Isr 1A	Primary current (A)	Accuracy class VA				
			cl. 5P5	cl. 5P10	cl. 5P15	cl. 5P20	
TAXE50D250	TAXE10D250	2500A	25	20	10	5	
TAXE50D300	TAXE10D300	3000A	30	25	15	7.5	
TAXE50D400	TAXE10D400	4000A	40	35	20	10	
TAXE50D500	TAXE10D500	5000A	50	40	25	10	
TAXE50D600	TAXE10D600	6000A	60	50	30	12.5	

Cat. Nos.		TAU131P					
		Passing cable window/bar 120x225mm					
Isr 5A	Isr 1A	Primary current (A)	Accuracy class VA				
			cl. 5P5	cl. 5P10	cl. 5P15	cl. 5P20	
TAXF50D250	TAXF10D250	2500A	25	20	10	5	
TAXF50D300	TAXF10D300	3000A	30	25	15	7.5	
TAXF50D400	TAXF10D400	4000A	40	35	20	10	
TAXF50D500	TAXF10D500	5000A	50	40	25	10	
TAXF50D600	TAXF10D600	6000A	60	50	30	12.5	
TAXF50D800	TAXF10D800	8000A	70	70	40	15	

Cat. Nos.		Accessories
	Description	
ATACOP05	Accessory sealable terminal cover	

Current transformers - PROTECTION

Cable/passing bar single-phase current transformer

Technical features

MODEL	TAU81P	TAU91P	TAU101P	TAU111P	TAU121P	TAU131P
TECHNICAL NOTES	NT715	NT716	NT718	NT720	NT821	NT822
SPECIFICATIONS						
Reference specification	EN/IEC 61869-1, 61869-2					
Rated primary current I _{pr} :	1500...4000A	1500...5000A	1500...6000A	1500...8000A	2500...6000A	2500...8000A
Rated frequency:	50Hz					
Working frequency:	47...63Hz					
Rated continuous thermal current I _{cth} :	100% I _{pr}					
Rated short-time thermal current I _{th} :	< 60I _{pr}					
Rated dynamic current I _{dyn} :	2,5I _{th}					
Rated secondary current I _{sr} :	5 - 1A					
Max. power dissipation	≤ 43W	≤ 66W	≤ 69W	≤ 124W	≤ 75W (1A) - ≤ 65W (5A)	≤ 70W
Allowed max cable or busbar temperature:	125°C					
INSULATION REQUIREMENTS						
Type	Dry transformer, air insulation					
Highest voltage for equipment U _m :	0.72kV r.m.s.					
Rated insulation level:	3kV r.m.s. 50Hz/1min					
Class of insulation (EN/IEC 61869-1, 61869-2):	B					
ENVIRONMENTAL CONDITIONS						
Nominal temperature range:	-25...50°C					
Limit temperature range for storage:	-40...85°C					
Relative humidity:	≤ 85%					
Suitable for tropical climates	yes					
CONNECTION						
Primary winding:	Passing bus bar					
Secondary winding	tightening by nut M5					
MECHANICAL FEATURES						
Housing material:	self extinguishing polycarbonate					
Protection degree (EN/IEC 60529):	IP20 housing, IP00 terminals (IP20 with sealable terminal cover)					
Weight:	4700 gr	5000 gr	5700 gr	6700 gr	7000 gr	8000 gr

Wiring diagrams

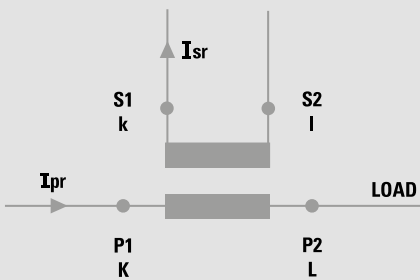

Dimensions

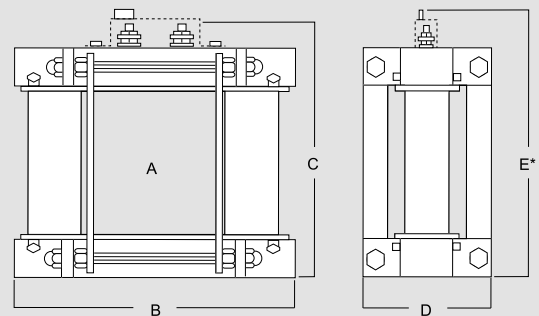

* option

Dim. (mm)	A	B	C	D	E
TAU81P	55x125	177	221	110	233.5
TAU91P	55x165	177	261	110	273.5
TAU101P	120x125	257	221	110	233.5
TAU111P	120x165	257	261	110	273.5
TAU121P	55x225	177	321	110	333.5
TAU131P	120x225	257	321	110	333.5

Voltage transformers - PROTECTION & MEASURE

Single-phase voltage transformer



BTV3



BTV6

Cat. Nos.		BTV3		Cat. Nos.		BTV6		Accuracy class VA		
100V	100V - $\sqrt{3}$	Primary voltage (V)	Accuracy class VA cl. 1	100V	100V - $\sqrt{3}$	Primary voltage (V)	Accuracy class VA cl. 0.5	Accuracy class VA cl. 1	Accuracy class VA cl. 3	
TVVAC100C100		100V	6	TVVBC100C100		100V	6	9	20	
TVVAC110C100		110V	6	TVVBC110C100		110V	6	9	20	
TVVAC115C100		115V	6	TVVBC115C100		115V	6	9	20	
TVVAC230C100		230V	6	TVVBC230C100		230V	6	9	20	
TVVAC240C100		240V	6	TVVBC240C100		240V	6	9	20	
TVVAC400C100		400V	6	TVVBC400C100		400V	6	9	20	
TVVAC440C100		440V	6	TVVBC440C100		440V	6	9	20	
TVVAC450C100		450V	6	TVVBC450C100		450V	6	9	20	
TVVAC500C100		500V	6	TVVBC500C100		500V	6	9	20	
TVVAC600C100		600V	6	TVVBC600C100		600V	6	9	20	
TVVAC660C100		660V	6	TVVBC660C100		660V	6	9	20	
TVVAC690C100		690V	6	TVVBC690C100		690V	6	9	20	
	TVVAG100G100	100V - $\sqrt{3}$	3		TVVBG100G100	100V - $\sqrt{3}$	3	4	10	
	TVVAG110G100	110V - $\sqrt{3}$	3		TVVBG110G100	110V - $\sqrt{3}$	3	4	10	
	TVVAG115G100	115V - $\sqrt{3}$	3		TVVBG115G100	115V - $\sqrt{3}$	3	4	10	
	TVVAG230G100	230V - $\sqrt{3}$	3		TVVBG230G100	230V - $\sqrt{3}$	3	4	10	
	TVVAG240G100	240V - $\sqrt{3}$	3		TVVBG240G100	240V - $\sqrt{3}$	3	4	10	
	TVVAG400G100	400V - $\sqrt{3}$	3		TVVBG400G100	400V - $\sqrt{3}$	3	4	10	
	TVVAG440G100	440V - $\sqrt{3}$	3		TVVBG440G100	440V - $\sqrt{3}$	3	4	10	
	TVVAG450G100	450V - $\sqrt{3}$	3		TVVBG450G100	450V - $\sqrt{3}$	3	4	10	
	TVVAG500G100	500V - $\sqrt{3}$	3		TVVBG500G100	500V - $\sqrt{3}$	3	4	10	
	TVVAG600G100	600V - $\sqrt{3}$	3		TVVBG600G100	600V - $\sqrt{3}$	3	4	10	
	TVVAG660G100	660V - $\sqrt{3}$	3		TVVBG660G100	660V - $\sqrt{3}$	3	4	10	
	TVVAG690G100	690V - $\sqrt{3}$	3		TVVBG690G100	690V - $\sqrt{3}$	3	4	10	

Voltage transformers - PROTECTION & MEASURE

Single-phase voltage transformer



BTV10



BTV20

Cat. Nos.		Primary voltage (V)	Accuracy class VA		
100V	100V - $\sqrt{3}$		cl. 0.5	cl. 1	cl. 3
TVVCC100C100		100V	10	15	30
TVVCC110C100		110V	10	15	30
TVVCC115C100		115V	10	15	30
TVVCC230C100		230V	10	15	30
TVVCC240C100		240V	10	15	30
TVVCC400C100		400V	10	15	30
TVVCC440C100		440V	10	15	30
TVVCC450C100		450V	10	15	30
TVVCC500C100		500V	10	15	30
TVVCC600C100		600V	10	15	30
TVVCC660C100		660V	10	15	30
TVVCC690C100		690V	10	15	30
TVVCG100G100	100V - $\sqrt{3}$	100V - $\sqrt{3}$	5	7	15
TVVCG110G100	110V - $\sqrt{3}$	110V - $\sqrt{3}$	5	7	15
TVVCG115G100	115V - $\sqrt{3}$	115V - $\sqrt{3}$	5	7	15
TVVCG230G100	230V - $\sqrt{3}$	230V - $\sqrt{3}$	5	7	15
TVVCG240G100	240V - $\sqrt{3}$	240V - $\sqrt{3}$	5	7	15
TVVCG400G100	400V - $\sqrt{3}$	400V - $\sqrt{3}$	5	7	15
TVVCG440G100	440V - $\sqrt{3}$	440V - $\sqrt{3}$	5	7	15
TVVCG450G100	450V - $\sqrt{3}$	450V - $\sqrt{3}$	5	7	15
TVVCG500G100	500V - $\sqrt{3}$	500V - $\sqrt{3}$	5	7	15
TVVCG600G100	600V - $\sqrt{3}$	600V - $\sqrt{3}$	5	7	15
TVVCG660G100	660V - $\sqrt{3}$	660V - $\sqrt{3}$	5	7	15
TVVCG690G100	690V - $\sqrt{3}$	690V - $\sqrt{3}$	5	7	15

Cat. Nos.		Primary voltage (V)	Accuracy class VA		
100V	100V - $\sqrt{3}$		cl. 0.5	cl. 1	cl. 3
TVVDC100C100		100V	20	30	50
TVVDC110C100		110V	20	30	50
TVVDC115C100		115V	20	30	50
TVVDC230C100		230V	20	30	50
TVVDC240C100		240V	20	30	50
TVVDC400C100		400V	20	30	50
TVVDC440C100		440V	20	30	50
TVVDC450C100		450V	20	30	50
TVVDC500C100		500V	20	30	50
TVVDC600C100		600V	20	30	50
TVVDC660C100		660V	20	30	50
TVVDC690C100		690V	20	30	50
TVVDC700C100		700V	20	30	50
TVVDC800C100		800V	20	30	50
TVVDD100C100		1000V	20	30	50
TVVDG100G100	100V - $\sqrt{3}$	100V - $\sqrt{3}$	8	10	25
TVVDG110G100	110V - $\sqrt{3}$	110V - $\sqrt{3}$	8	10	25
TVVDG115G100	115V - $\sqrt{3}$	115V - $\sqrt{3}$	8	10	25
TVVDG230G100	230V - $\sqrt{3}$	230V - $\sqrt{3}$	8	10	25
TVVDG240G100	240V - $\sqrt{3}$	240V - $\sqrt{3}$	8	10	25
TVVDG400G100	400V - $\sqrt{3}$	400V - $\sqrt{3}$	8	10	25
TVVDG440G100	440V - $\sqrt{3}$	440V - $\sqrt{3}$	8	10	25
TVVDG450G100	450V - $\sqrt{3}$	450V - $\sqrt{3}$	8	10	25
TVVDG500G100	500V - $\sqrt{3}$	500V - $\sqrt{3}$	8	10	25
TVVDG600G100	600V - $\sqrt{3}$	600V - $\sqrt{3}$	8	10	25
TVVDG660G100	660V - $\sqrt{3}$	660V - $\sqrt{3}$	8	10	25
TVVDG690G100	690V - $\sqrt{3}$	690V - $\sqrt{3}$	8	10	25
TVVDG700G100	700V - $\sqrt{3}$	700V - $\sqrt{3}$	8	10	25
TVVDG800G100	800V - $\sqrt{3}$	800V - $\sqrt{3}$	8	10	25
TVVDH100G100	1000V - $\sqrt{3}$	1000V - $\sqrt{3}$	8	10	25

Cat. Nos.	Accessories
ATVCOF01	Description Primary / secondary sealable terminal cover

Voltage transformers - PROTECTION & MEASURE

Single-phase voltage transformer



BTV50



BTV100

Cat. Nos.		BTV50				Cat. Nos.		BTV100			
100V	100V - √3	Primary voltage (V)	Accuracy class VA			100V	100V - √3	Primary voltage (V)	Accuracy class VA		
			cl. 0.5	cl. 1	cl. 3				cl. 0.5	cl. 1	cl. 3
TVVEC100C100		100V	50	75	100	TVVFC100C100		100V	100	150	200
TVVEC110C100		110V	50	75	100	TVVFC110C100		110V	100	150	200
TVVEC115C100		115V	50	75	100	TVVFC115C100		115V	100	150	200
TVVEC230C100		230V	50	75	100	TVVFC230C100		230V	100	150	200
TVVEC240C100		240V	50	75	100	TVVFC240C100		240V	100	150	200
TVVEC400C100		400V	50	75	100	TVVFC400C100		400V	100	150	200
TVVEC440C100		440V	50	75	100	TVVFC440C100		440V	100	150	200
TVVEC450C100		450V	50	75	100	TVVFC450C100		450V	100	150	200
TVVEC500C100		500V	50	75	100	TVVFC500C100		500V	100	150	200
TVVEC600C100		600V	50	75	100	TVVFC600C100		600V	100	150	200
TVVEC660C100		660V	50	75	100	TVVFC660C100		660V	100	150	200
TVVEC690C100		690V	50	75	100	TVVFC690C100		690V	100	150	200
TVVEC700C100		700V	50	75	100	TVVFC700C100		700V	100	150	200
TVVEC800C100		800V	50	75	100	TVVFC800C100		800V	100	150	200
TVVED100C100		1000V	50	75	100	TVVFD100C100		1000V	100	150	200
	TVVEG100G100	100V - √3	25	30	50		TVVFG100G100	100V - √3	50	75	100
	TVVEG110G100	110V - √3	25	30	50		TVVFG110G100	110V - √3	50	75	100
	TVVEG115G100	115V - √3	25	30	50		TVVFG115G100	115V - √3	50	75	100
	TVVEG230G100	230V - √3	25	30	50		TVVFG230G100	230V - √3	50	75	100
	TVVEG240G100	240V - √3	25	30	50		TVVFG240G100	240V - √3	50	75	100
	TVVEG400G100	400V - √3	25	30	50		TVVFG400G100	400V - √3	50	75	100
	TVVEG440G100	440V - √3	25	30	50		TVVFG440G100	440V - √3	50	75	100
	TVVEG450G100	450V - √3	25	30	50		TVVFG450G100	450V - √3	50	75	100
	TVVEG500G100	500V - √3	25	30	50		TVVFG500G100	500V - √3	50	75	100
	TVVEG600G100	600V - √3	25	30	50		TVVFG600G100	600V - √3	50	75	100
	TVVEG660G100	660V - √3	25	30	50		TVVFG660G100	660V - √3	50	75	100
	TVVEG690G100	690V - √3	25	30	50		TVVFG690G100	690V - √3	50	75	100
	TVVEG700G100	700V - √3	25	30	50		TVVFG700G100	700V - √3	50	75	100
	TVVEG800G100	800V - √3	25	30	50		TVVFG800G100	800V - √3	50	75	100
	TVVEH100G100	1000V - √3	25	30	50		TVVFH100G100	1000V - √3	50	75	100

Cat. Nos.	Accessories
	Description
ATVCOP01	Primary / secondary sealable terminal cover

Voltage transformers - PROTECTION & MEASURE

Single-phase voltage transformer

Technical features

MODEL	BTV3	BTV6	BTV10	BTV20	BTV50	BTV100
TECHNICAL NOTES	NT733	NT734	NT735	NT736	NT737	NT738
SPECIFICATIONS						
Reference specification	EN/IEC61869-1, EN/IEC61869-3					
Rated primary voltage U _{pr} :	100...690V (phase-phase) - 100...690V - √3 (phase-neutral)					
Rated secondary voltage U _{sr} :	100V (phase-phase) - 100V - √3 (phase-neutral)					
Rated frequency:	50Hz					
Working frequency:	47...63Hz					
Continuous rated time:	1.2 U _{pr}					
8 hours rated time:	1,9U _{pr} (phase-neutral and primary U _{pr} :√3 connection)					
Max. power dissipation	≤ 9W	≤ 8.5W	≤ 7W	≤ 8.5W	≤ 11W	≤ 32W
The allowed max cable or busbar temperature is:	125°C					
INSULATION REQUIREMENTS						
Type	Dry transformer, air insulation					
Highest voltage for equipment U _m :	0.72kV r.m.s. (≤ 600V) - 1.2kV (>600V)					
Rated insulation level:	3kV (≤ 600V) - 6kV (>600V) r.m.s. 50Hz/1min					
Class of insulation (EN/IEC61869-1):	B					
ENVIRONMENTAL CONDITIONS						
Nominal temperature range:	-25...50°C					
Limit temperature range for storage:	-40...85°C					
Relative humidity:	≤ 85%					
Suitable for tropical climates	yes					
CONNECTION						
Primary and secondary winding:	M4 and fast-ons 6,3x0,8mm					
MECHANICAL FEATURES						
Housing material:	metal					
Protection degree (EN/IEC 60529):	IP00 terminals	IP00 terminals (IP20 with terminal cover)				
Mounting:	Fixing screw facility for wall mounting					
Weight:	2350 gr	2700 gr	3100 gr	2700 gr	6100 gr	7500 gr

Wiring diagrams

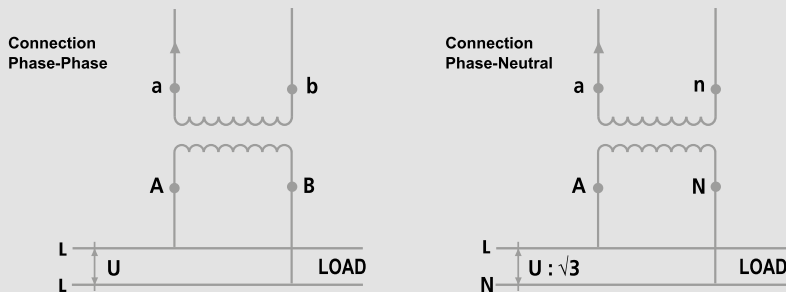

Dimensions

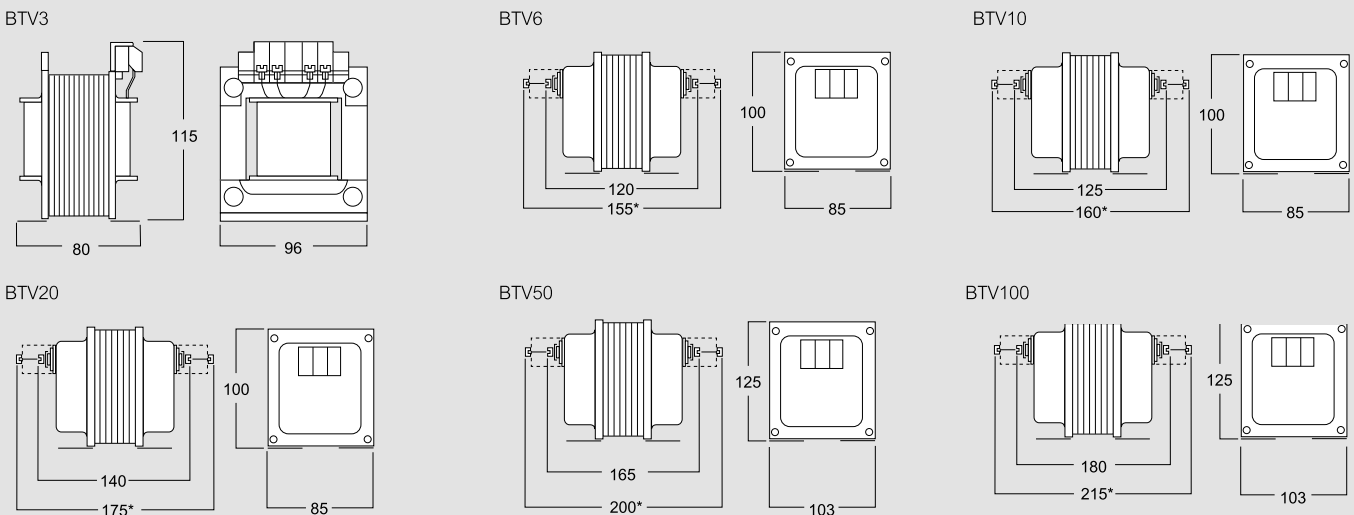

* with sealable terminal cover

Voltage transformers - ACCURACY

Single-phase voltage transformer



BTV6 -BTV10



BTV20

Cat. Nos.		BTV6	
100V	100V - √3	Primary voltage (V)	
TVVBC230C100S		230V	2.5
TVVBC240C100S		240V	2.5
TVVBC400C100S		400V	2.5
TVVBC440C100S		440V	2.5
TVVBC450C100S		450V	2.5
TVVBC500C100S		500V	2.5
TVVBC600C100S		600V	2.5
TVVBC660C100S		660V	2.5
TVVBC690C100S		690V	2.5
	TVVBG230G100S	230V - √3	1
	TVVBG240G100S	240V - √3	1
	TVVBG400G100S	400V - √3	1
	TVVBG440G100S	440V - √3	1
	TVVBG450G100S	450V - √3	1
	TVVBG500G100S	500V - √3	1
	TVVBG600G100S	600V - √3	1
	TVVBG660G100S	660V - √3	1
	TVVBG690G100S	690V - √3	1

Cat. Nos.		BTV20		Accuracy class VA cl. 0.2	
100V	100V - √3	Primary voltage (V)			
TVVDC230C100S		230V			8
TVVDC240C100S		240V			8
TVVDC400C100S		400V			8
TVVDC440C100S		440V			8
TVVDC450C100S		450V			8
TVVDC500C100S		500V			8
TVVDC600C100S		600V			8
TVVDC660C100S		660V			8
TVVDC690C100S		690V			8
TVVDC700C100S		700V			8
TVVDC800C100S		800V			8
TVVDD100C100S		1000V			8
	TVVDG230G100S	230V - √3			3
	TVVDG240G100S	240V - √3			3
	TVVDG400G100S	400V - √3			3
	TVVDG440G100S	440V - √3			3
	TVVDG450G100S	450V - √3			3
	TVVDG500G100S	500V - √3			3
	TVVDG600G100S	600V - √3			3
	TVVDG660G100S	660V - √3			3
	TVVDG690G100S	690V - √3			3
	TVVDG700G100S	700V - √3			3
	TVVDG800G100S	800V - √3			3
	TVVHG100G100S	1000V - √3			3

Cat. Nos.		BTV10	
100V	100V - √3	Primary voltage (V)	
TVVCC230C100S		230V	4
TVVCC240C100S		240V	4
TVVCC400C100S		400V	4
TVVCC440C100S		440V	4
TVVCC450C100S		450V	4
TVVCC500C100S		500V	4
TVVCC600C100S		600V	4
TVVCC660C100S		660V	4
TVVCC690C100S		690V	4
	TVVCG230G100S	230V - √3	2
	TVVCG240G100S	240V - √3	2
	TVVCG400G100S	400V - √3	2
	TVVCG440G100S	440V - √3	2
	TVVCG450G100S	450V - √3	2
	TVVCG500G100S	500V - √3	2
	TVVCG600G100S	600V - √3	2
	TVVCG660G100S	660V - √3	2
	TVVCG690G100S	690V - √3	2

Cat. Nos.		Accessories	
		Description	
ATVCOP01		Primary / secondary sealable terminal cover	

Voltage transformers - ACCURACY

Single-phase voltage transformer



BTV50



BTV100

Cat. Nos.		BTV50		Cat. Nos.		BTV100	
100V	100V - $\sqrt{3}$	Primary voltage (V)	Accuracy class VA cl. 0.2	100V	100V - $\sqrt{3}$	Primary voltage (V)	Accuracy class VA cl. 0.2
TVVEC230C100S		230V	20	TVVFC230C100S		230V	40
TVVEC240C100S		240V	20	TVVFC240C100S		240V	40
TVVEC400C100S		400V	20	TVVFC400C100S		400V	40
TVVEC440C100S		440V	20	TVVFC440C100S		440V	40
TVVEC450C100S		450V	20	TVVFC450C100S		450V	40
TVVEC500C100S		500V	20	TVVFC500C100S		500V	40
TVVEC600C100S		600V	20	TVVFC600C100S		600V	40
TVVEC660C100S		660V	20	TVVFC660C100S		660V	40
TVVEC690C100S		690V	20	TVVFC690C100S		690V	40
TVVEC700C100S		700V	20	TVVFC700C100S		700V	40
TVVEC800C100S		800V	20	TVVFC800C100S		800V	40
TVVED100C100S		1000V	20	TVVFD100C100S		1000V	40
	TVVEG230G100S	230V - $\sqrt{3}$	8		TVVFG230G100S	230V - $\sqrt{3}$	14
	TVVEG240G100S	240V - $\sqrt{3}$	8		TVVFG240G100S	240V - $\sqrt{3}$	14
	TVVEG400G100S	400V - $\sqrt{3}$	8		TVVFG400G100S	400V - $\sqrt{3}$	14
	TVVEG440G100S	440V - $\sqrt{3}$	8		TVVFG440G100S	440V - $\sqrt{3}$	14
	TVVEG450G100S	450V - $\sqrt{3}$	8		TVVFG450G100S	450V - $\sqrt{3}$	14
	TVVEG500G100S	500V - $\sqrt{3}$	8		TVVFG500G100S	500V - $\sqrt{3}$	14
	TVVEG600G100S	600V - $\sqrt{3}$	8		TVVFG600G100S	600V - $\sqrt{3}$	14
	TVVEG660G100S	660V - $\sqrt{3}$	8		TVVFG660G100S	660V - $\sqrt{3}$	14
	TVVEG690G100S	690V - $\sqrt{3}$	8		TVVFG690G100S	690V - $\sqrt{3}$	14
	TVVEG700G100S	700V - $\sqrt{3}$	8		TVVFG700G100S	700V - $\sqrt{3}$	14
	TVVEG800G100S	800V - $\sqrt{3}$	8		TVVFG800G100S	800V - $\sqrt{3}$	14
	TVVEH100G100S	1000V - $\sqrt{3}$	8		TVVFH100G100S	1000V - $\sqrt{3}$	14

Cat. Nos.	Accessories
ATVCOP01	Description Primary / secondary sealable terminal cover

Voltage transformers - ACCURACY

Single-phase voltage transformer

Technical features

MODEL	BTV6	BTV10	BTV20	BTV50	BTV100
TECHNICAL NOTES	NT836	NT837	NT837	NT839	NT840
SPECIFICATIONS					
Reference specification	EN/IEC61869-1, EN/IEC61869-3				
Rated primary voltage U _{pr} :	230...690V (phase-phase) - 230...690V - √3 (phase-neutral)				
Rated secondary voltage U _{sr} :	100V (phase-phase) - 100V - √3 (phase-neutral)				
Rated frequency:	50Hz				
Working frequency:	47...63Hz				
Continuous rated time:	1.2 U _{pr}				
8 hours rated time:	1.9U _{pr} (phase-neutral and primary U _{pr} :√3 connection)				
Max. power dissipation	≤ 7W	≤ 8.5W	≤ 8.5W	≤ 11W	≤ 32W
The allowed max cable or busbar temperature is:	125°C				
INSULATION REQUIREMENTS					
Type	Dry transformer, air insulation				
Highest voltage for equipment U _m :	0.72kV r.m.s. (≤ 600V) - 1.2kV (>600V)				
Rated insulation level:	3kV (≤ 600V) - 6kV (>600V) r.m.s. 50Hz/1min				
Class of insulation (EN/IEC61869-1):	B				
ENVIRONMENTAL CONDITIONS					
Reference temperature:	23°C ± 1°C				
Nominal temperature range:	-25...50°C				
Daily mean temperature:	≤ 30°C				
Limit temperature range for storage:	-40...85°C				
Relative humidity:	≤ 85%				
Suitable for tropical climates	yes				
CONNECTION					
Primary and secondary winding:	M4 and fast-ons 6,3x0,8mm				
MECHANICAL FEATURES					
Housing material:	metal				
Protection degree (EN/IEC 60529):	IP00 terminals (IP20 with terminal cover)				
Mounting:	Fixing screw facility for wall mounting				
Weight:	2700 gr	3100 gr	2700 gr	6100 gr	7500 gr

Wiring diagrams

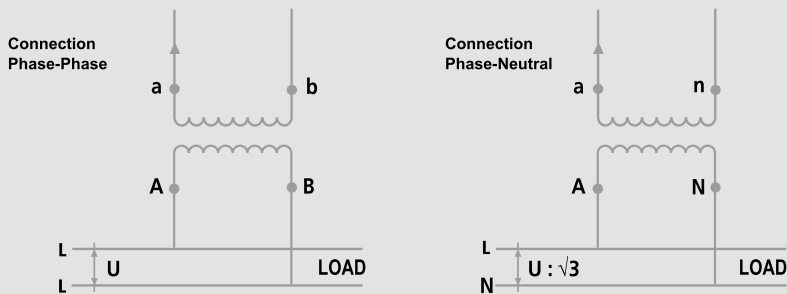

Dimensions

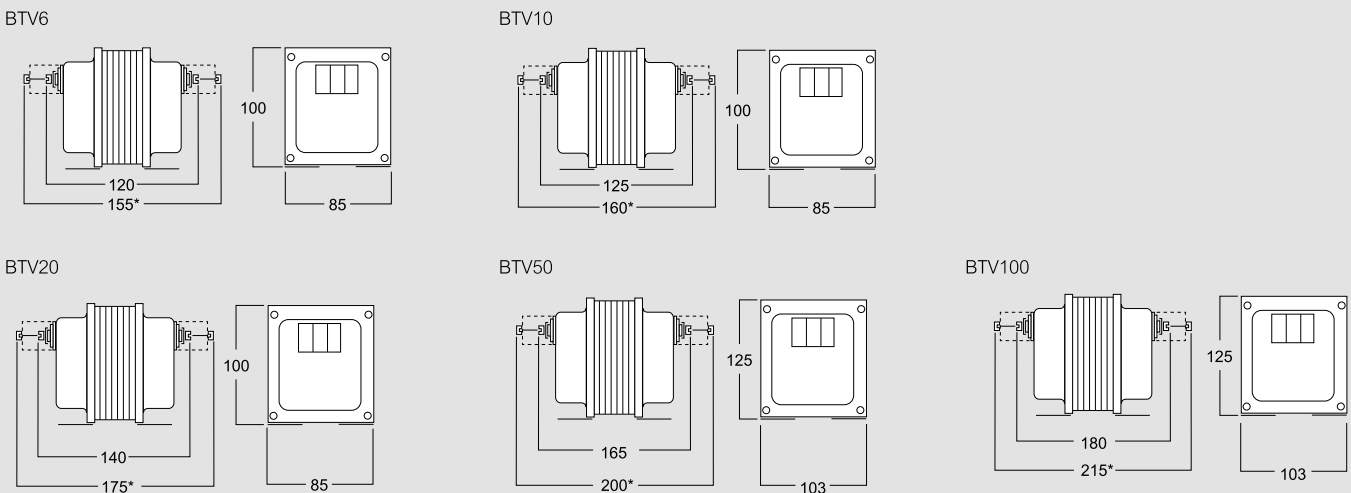

* with sealable terminal cover

Transformers

Accessories



DER60...

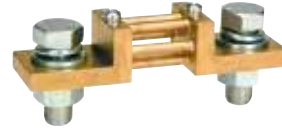

ATAP015

Cat. Nos.

DER Shunts for direct current measure

It gives a mV signal directly proportional to the measured current
 Primary current 1...25A
 Voltage drop 60 – 100 – 150mV
 Accuracy cl. 0,5
 Dimensions according to DIN43703

60mV	100mV	150mV	Range
DER060A100	DER100A100	DER150A100	1A
DER060A150	DER100A150	DER150A150	1.5A
DER060A200	DER100A200	DER150A200	2A
DER060A250	DER100A250	DER150A250	2.5A
DER060A300	DER100A300	DER150A300	3A
DER060A400	DER100A400	DER150A400	4A
DER060A500	DER100A500	DER150A500	5A
DER060A600	DER100A600	DER150A600	6A
DER060A800	DER100A800	DER150A800	8A
DER060B100	DER100B100	DER150B100	10A
DER060B150	DER100B150	DER150B150	15A
DER060B200	DER100B200	DER150B200	20A
DER060B250	DER100B250	DER150B250	25A

Cat. Nos.

DER Shunts for direct current measure

It gives a mV signal directly proportional to the measured current
 Primary current 30...6000A
 Voltage drop 60 – 100 – 150mV
 Accuracy cl. 0,5
 Dimensions according to DIN43703

60mV	100mV	150mV	Range
DER060B300	DER100B300	DER150B300	30A
DER060B400	DER100B400	DER150B400	40A
DER060B500	DER100B500	DER150B500	50A
DER060B600	DER100B600	DER150B600	60A
DER060B800	DER100B800	DER150B800	80A
DER060C100	DER100C100	DER150C100	100A
DER060C120	DER100C120	DER150C120	120A
DER060C150	DER100C150	DER150C150	150A
DER060C200	DER100C200	DER150C200	200A
DER060C250	DER100C250	DER150C250	250A
DER060C300	DER100C300	DER150C300	300A
DER060C400	DER100C400	DER150C400	400A
DER060C500	DER100C500	DER150C500	500A
DER060C600	DER100C600	DER150C600	600A
DER060C800	DER100C800	DER150C800	800A
DER060D100	DER100D100	DER150D100	1000A
DER060D120	DER100D120	DER150D120	1200A
DER060D150	DER100D150	DER150D150	1500A
DER060D200	DER100D200	DER150D200	2000A
DER060D250	DER100D250	DER150D250	2500A
DER060D300	DER100D300	DER150D300	3000A
DER060D400	DER100D400	DER150D400	4000A
DER060D500	DER100D500	DER150D500	5000A
DER060D600	DER100D600	DER150D600	6000A



ATAP015

Cat. Nos. CT accessory

Description
ATAP015

CT /1A or /5A*secondary opening protection .
 Fully static accessory which can instantly reclose the CT secondary circuit opened due to connection breakdown or to the removal of connected devices, to avoid dangerous overvoltages generated by the opening, and automatic instantaneous reset when normal conditions are restored.

RESIDUAL CURRENT RELAIS

DELTA



The range of Delta relais are the ideal for use in the industrial and service sectors, in public lighting and in building automatic machines, they comply with standards of protection CEI EN standard 60947-2 appendices B and M class A, anyway compatible with pulsing currents.

- ▶ The range of **Delta** modular, flush mounting and residual current relay in combination with current transformers Del and Del A (open core type), has the aim of protecting people and property while assuring system continuity of service.



Permanent connection control

An important feature of the Delta series is the permanent connection control of circuit between residual current relay and C.T.: by detecting of any anomaly in the connection between C.T. and E.L.R., the protection automatically intervenes, without waiting for the periodic check to carry out by test push button.

Δt intervention time adjustment







The Δt tripping time adjustment makes this series ideal for the creation of selective protection systems; adjustment in $I\Delta n$ current makes it possible to protect people and property against undesired or dangerous dispersions.

Version with harmonic filter

With the evolution of system requirements and the introduction into the systems of devices fitted with power electronics, the F models have been created with harmonic filter for systems that are subject to considerable disruption.







Residual current relay

Table of choice

									
Model		D2-I	D2-s	D4-s	D4-f	D4h	D4-l	48-s	
Cat. nos.		RD1AF...	RD3AF...	RD4B2...	RD3B2...	RDD4...	RD2B213B	RD1DF...	
Technical notes		NT544	NT597	NT871	NT865	NT897	NT748	NT556	
Ranges	19: 0,03...30A	*	*	*	*		*	*	
	18: 0,5...30A					*			
Istantaneous	t=0s a/at IΔn 30mA	*	*	*	*	*	*	*	
Waveform	Sinusoidal (AC type)	*	*	*	*	*	*	*	
	Chopped pulsating with superimposed dc (A type)	*	*	*	*	*	*	*	
Filter for harmonics	Selectable				*	*	*		
	Fixed								
Reference standard	EN60947-2 IEC60947-2	*	*	*	*	*	*	*	
Alarm	1 Relay Output	*	*		(2)			*	
	2 Relays Output			(2)		*	*		
	1 Output + Pre-alarm			(2)	(2)		(2)		
IΔn display	LED Bargraph		*	*	*		*		
	Display					*			
Output relay	SPDT	*	*					*	
	SPDT + SPST								
	2 SPDT			*	*	*	*		
Positive/negative safety	Selectable	*	*	*	*	*	*	*	
Test	Local	*	*	*	*	*	*	*	
	Remote	(1)	(1)	*	(1)	*		(1)	
	Automatic	*	*	*	*	*	*	*	
Reset	Local	*	*	*	*	*	*	*	
	Remote	*	*	*	*	*	*	*	
	Automatic	*	*	*		*		*	
Auxiliary power supply	230Vac	*	*	*	*	*	*	*	
	24-48-115-240-400Vac	*	*	*	*	*		*	
	20...150Vdc	*	*	*	*	*		*	
	10...36Vdc	*	*		*	*			
Dimensions	2 Module	*	*						
	4 Module			*	*	*	*		
	48 x 48 mm							*	
	72 x 72 mm								
	96 x 96 mm								
Communication	RS485					*			
	RS232					*			
	Ethernet					*			

(1) Not available with aux. supply 20...150Vdc-48Vac

(2) On choice

						
48-s	72-s	72-s	72-h	72-f	96-s	96-f
RD1D2...	RD1EP...	RD1E2...	RD3E2...	RD2E2...	RD1G2...	RD2G2...
NT711	NT552	NT692	NT649	NT745	NT691	NT746
*	*	*	*		*	
				*		*
*	*	*	*		*	
*	*	*	*	*	*	*
*	*	*	*	*	*	*
						*
*	*	*	*	*	*	*
*		(2)	(2)	(2)	(2)	(2)
	*	(2)	(2)	(2)	(2)	(2)
	*	*	*	*	*	*
			*			
			*			
*	*	*	*	*	*	*
*	*	*	*	*	*	*
*	*	*	*	*	*	*
*	*	*	*	*	*	*
(1)	(1)	(1)	*	(1)	(1)	(1)
*	*	*	*	*	*	*
*	*	*	*	*	*	*
*	*	*	*	*	*	*
*	*	*	*	*	*	*
*	*	*	*	*	*	*
*	*	*	*	*	*	*
*	*	*	*	*	*	*
*	*	*	*	*	*	*
*	*	*	*	*	*	*
*	*	*	*	*	*	*
*	*	*	*	*	*	*
*	*	*	*	*	*	*
*						
	*	*	*	*		*
					*	*

Residual current relay

Residual current relay A type 2 module



DELTA D2-I



DELTA D2-s

Cat. Nos. **DELTA D2-I**

Instantaneous ($t = 0$) at $I_{\Delta n}$ 30mA
 Selectable set point
 30mA...30A (19 ranges)
 Field-selectable negative or positive security (fail safe)
 Automatic permanent test
 Manual or automatic reset (3 restart attempts)

	$I_{\Delta n}$ (A)	V_n	t (s)
RD1AF11B	0.03...30A	24Vac	0-0.15-0.25-0.5-1-2.5-5
RD1AF12B		115Vac	
RD1AF13B		230Vac	
RD1AF15B		400Vac	
RD1AF1HB		20...150Vdc + 48Vac	

Cat. Nos. **DELTA D2-s with LED bar**

Instantaneous ($t = 0$) at $I_{\Delta n}$ 30mA
 Selectable set point
 30mA...30A (19 ranges)
 Instantaneous display as percentage of $I_{\Delta n}$
 Field-selectable negative or positive security (fail safe)
 Automatic permanent test
 Manual or automatic reset (3 restart attempts)

	$I_{\Delta n}$ (A)	V_n	t (s)
RD3AF11B	0.03...30A	24Vac	0-0.15-0.25-0.5-1-2.5-5
RD3AF12B		115Vac	
RD3AF13B		230Vac	
RD3AF15B		400Vac	
RD3AF1HB		20...150Vdc + 48Vac	

Technical features

MODEL	DELTA D2-L	DELTA D2-S
TECHNICAL NOTES	NT544	NT597
INPUT		
Reference specification:	EN60947-2 IEC60947-2	
Connection:	low voltage lines, with series TD transformer	
Waveform $I_{\Delta n}$:	sinusoidal (type AC) or chopped pulsating with superimposed dc (type A) according to EN60947-2 (annex B and M) IEC60947-2	
Rated frequency f_n :	50Hz	
Working frequency:	47...63Hz	
SET UP		
Current set point $I_{\Delta n}$:	selectable by 7-position potentiometer, 3 ranges x1 - x10 - x100	
Ranges $I_{\Delta n}$:	0.03 - 0.05 - 0.075 - 0.1 - 0.15 - 0.2 - 0.3 (x1 - x10 - x100)	
Non-operating residual current:	0.5 $I_{\Delta n}$	
Adjustable Intervention time t :	0 - 0.15 - 0.25 - 0.5 - 1 - 2.5 - 5 sec	
SIGNALING AND ALARM		
Power ON:	green LED "ON"	
Instantaneous value $I_{\Delta n}$:	-	3 LED's, 20 - 40 - 60% of set $I_{\Delta n}$ value (DELTA D2-S only)
Alarm intervention:	red LED "TRIP" + relay switching	
Ring current transformer-relay connection failure:	red LED "TRIP" blinking + relay switching	
TRIP state memorization:	1 red LED "TRIP" + relay self-retaining 1 excluded with automatic reset	
Reset:	manual or automatic, selectable by dip switch	
Local manual:	front key	
Remote manual:	external contact closing	
Automatic:	3 restart attempts (1 each 60 seconds)	
Inhibited reset with persistent residual current:	> 50% $I_{\Delta n}$	
OUTPUT		
Relay:	1 SPDT contact	
Contact range:	5A 250Vac $\cos\phi$ 1 - 3A 250Vac $\cos\phi$ 0.4 - 5A 30Vdc	
Negative security (normally de-energised relay) or positive security fail safe (normally energised relay): selectable by dip switch		
AUXILIARY SUPPLY		
Rated value U_{aux} :	24V - 48V - 115V - 230V - 240V - 400V	
Tolerance:	0,85...1,1 U_{aux} - 40...60V (U_{aux} 48V)	
Rated frequency:	50Hz (47...63Hz)	
Rated burden:	\leq 2.5VA	
Rated value U_{aux} :	20...150Vdc	
Protected against incorrect polarity	yes	
Rated burden:	\leq 2.5W	
Immunity to short interruption of supply voltage up to 300ms (Rated U_{aux})		
TESTS FOR ELECTROMAGNETIC COMPATIBILITY		
Emission/Immunity tests according to	EN / IEC 60947-2	
ENVIRONMENTAL CONDITIONS		
Nominal temperature range:	-5...50°C	
Limit temperature range for storage:	-40...70°C	
Suitable for tropical climates:	yes	
Max. power dissipation:	\leq 2W *	
MECHANICAL FEATURES		
Housing:	2 module DIN 43880 (35mm)	
Front frame:	sealable to avoid improper opening	
Connections:	screw terminals for cable up to 4 mm ²	
Housing material:	self-extinguishing polycarbon ate	
Protection degree (EN / IEC 60529):	IP50 front frame, IP20 terminals	

* for switchboard thermal calculation

Wiring diagrams

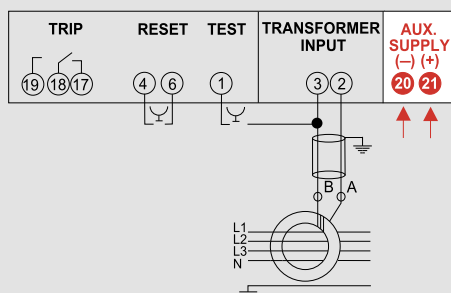

Residual current relay

Residual current relay A type 4 module



Cat. Nos.

DELTA D4-s

Instantaneous ($t = 0$) at $I_{\Delta n}$ 30mA
 Selectable set point 30mA...30A (19 ranges)
 Instantaneous display as percentage of $I_{\Delta n}$
 Alarm + pre-alarm or alarm function with 2 SPDT contact
 Field-selectable negative or positive security (fail safe)
 Automatic permanent test
 Automatic restart (up to 10 attempts) in case of transient earth fault
 "No trip" TEST (local, without output relay tripping)
 Sealable front frame

	$I_{\Delta n}$ (A)	V_n	t (s)
RD4B211B	0.03...30A	24Vac	0-0.06-0.15-0.31- 0.5-1-4.5
RD4B212B		115Vac	
RD4B213B		230Vac	
RD4B215B		400Vac	
RD4B21HB		20...150Vdc + 48Vac	

Technical features

TECHNICAL NOTES	NT871
INPUT	
Reference specification:	EN60947-2 IEC60947-2
Connection:	low voltage lines, with series TD transformer
Waveform $I_{\Delta n}$:	sinusoidal (type AC) or chopped pulsating with superimposed dc (type A) according to EN60947-2 (annex B and M) IEC60947-2
Rated frequency fn:	50Hz
Working frequency:	47...63Hz
SET UP	
Current set point $I_{\Delta n}$:	selectable by 7-position potentiometer, 3 ranges x1 - x10 - x100
Ranges $I_{\Delta n}$:	0.03 - 0.05 - 0.075 - 0.1 - 0.15 - 0.2 - 0.3 (x1 - x10 - x100)
Non-operating residual current:	0.5 $I_{\Delta n}$
Adjustable Intervention time t:	0-0,06-0,15-0,31-0,5-1-4,5s
SIGNALING AND ALARM	
Power ON:	green LED "ON"
Instantaneous value $I_{\Delta n}$:	4 LED's, 20 - 30 - 40 - 50% of set $I_{\Delta n}$ value
Alarm intervention:	red LED "TRIP" + relay switching
Ring current transformer-relay connection failure:	red LED "TRIP" blinking + relay switching
TRIP state memorization:	1 red LED "TRIP" + relay self-retaining
Reset:	manual or automatic, selectable by dip switch
Local manual:	front key
Remote manual:	external contact closing
Automatic:	10 restart attempts (30s...256 min)
Inhibited reset with persistent residual current:	> 50% $I_{\Delta n}$
OUTPUT	
Relay:	1 SPDT contact
Contact range:	5A 250Vac $\cos\phi$ 1 - 3A 250Vac $\cos\phi$ 0.4 - 5A 30Vdc
AUXILIARY SUPPLY	
Rated value U_{aux} :	24V - 48V - 115V - 230V - 240V - 400V
Tolerance:	0,85...1,1 U_{aux} - 40...60V (U_{aux} 48V)
Rated frequency:	50Hz (47...63Hz)
Rated burden:	\leq 2,5VA
Rated value U_{aux} :	20...150Vdc
Protected against incorrect polarity:	yes
Rated burden:	\leq 2,5W
Immunity to short interruption of supply voltage up to 300ms (Rated U_{aux})	
TESTS FOR ELECTROMAGNETIC COMPATIBILITY	
Emission/Immunity tests according to	EN / IEC 60947-2
ENVIRONMENTAL CONDITIONS	
Nominal temperature range:	-5...50°C
Limit temperature range for storage:	-40...70°C
Suitable for tropical climates:	yes
Max. power dissipation:	\leq 2W *
MECHANICAL FEATURES	
Housing:	4 module DIN 43880 (35mm)
Front frame:	sealable to avoid improper opening
Connections:	screw terminals for cable up to 4 mm ²
Housing material:	self-extinguishing polycarbonate
Protection degree (EN / IEC 60529):	IP40 front frame, IP20 terminals

* for switchboard thermal calculation

Wiring diagrams

DELTA D4-S

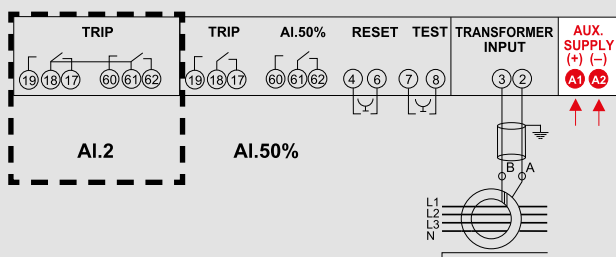

Residual current relay

Residual current relay A type 4 module with powered filter



Cat. Nos. **DELTA D4-f**

Instantaneous ($t = 0$) at I_{dn} 30mA
 Selectable set point 30mA...30A (19 ranges)
 Instantaneous display as percentage of I_{dn}
 Filter for harmonics, field-selectable
 Alarm function + pre-alarm or alarm + power fail signaling
 Field selectable negative or positive security
 Automatic permanent test

	I_{dn} (A)	V_n	t (s)
RD3B211B	0.03...30A	24Vac	0-0.15-0.25-0.5- 1-2.5-5
RD3B212B		115Vac	
RD3B213B		230Vac	
RD3B215B		400Vac	
RD3B21HB		20...150Vdc + 48Vac	

Technical features

TECHNICAL NOTES	NT865
INPUT	
Reference specification:	EN60947-2 IEC60947-2
Connection:	low voltage lines, with series TD transformer
Waveform $I_{\Delta n}$:	sinusoidal (type AC) or chopped pulsating with superimposed dc (type A) according to EN60947-2 (annex B and M) IEC60947-2
Rated frequency fn:	50Hz
Working frequency:	47...63Hz
SET UP	
Current set point $I_{\Delta n}$:	selectable by 7-position potentiometer, 3 ranges x1 - x10 - x100
Ranges $I_{\Delta n}$:	0.03 - 0.05 - 0.075 - 0.1 - 0.15 - 0.2 - 0.3 (x1 - x10 - x100)
Non-operating residual current:	0.5 $I_{\Delta n}$
Adjustable Intervention time t:	0-0,15-0,25-0,5-1-2,5-5s
SIGNALING AND ALARM	
Power ON:	green LED "ON"
Alarm intervention:	red LED "TRIP" + relay switching
Ring current transformer-relay connection failure:	red LED "TRIP" blinking + relay switching
TRIP state memorization:	1 red LED "TRIP" + relay self-retaining
Reset:	manual or automatic, selectable by dip switch
Local manual:	front key
Remote manual:	external contact closing
Automatic:	10 restart attempts (30s...256 min)
Inhibited reset with persistent residual current:	> 50% $I_{\Delta n}$
OUTPUT	
Relay:	1 SPDT contact
Contact range:	5A 250Vac $\cos\phi$ 1 - 3A 250Vac $\cos\phi$ 0.4 - 5A 30Vdc
AUXILIARY SUPPLY	
Rated value U_{aux} :	24V - 48V - 115V - 230V - 240V - 400V
Tolerance:	0,85...1,1 U_{aux} - 40...60V (U_{aux} 48V)
Rated frequency:	50Hz (47...63Hz)
Rated burden:	\leq 2.5VA
Rated value U_{aux} :	20...150Vdc
Protected against incorrect polarity:	yes
Rated burden:	\leq 2.5W
Immunity to short interruption of supply voltage up to 300ms (Rated U_{aux})	
TESTS FOR ELECTROMAGNETIC COMPATIBILITY	
Emission/Immunity tests according to	EN / IEC 60947-2
ENVIRONMENTAL CONDITIONS	
Nominal temperature range:	-5...50°C
Limit temperature range for storage:	-40...70°C
Suitable for tropical climates:	yes
Max. power dissipation:	\leq 2W *
MECHANICAL FEATURES	
Housing:	4 module DIN 43880 (35mm)
Front frame:	sealable to avoid improper opening
Connections:	screw terminals for cable up to 4 mm ²
Housing material:	self-extinguishing polycarbonate
Protection degree (EN / IEC 60529):	IP40 front frame, IP20 terminals

* for switchboard thermal calculation

Wiring diagrams

DELTA D4-F

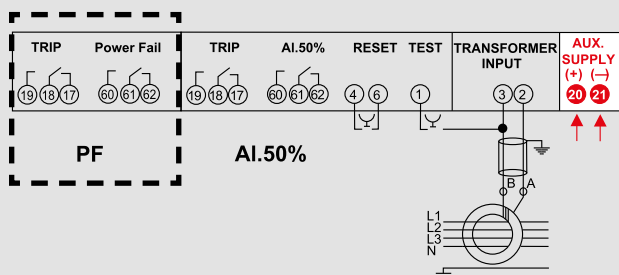

Residual current relay

Residual current relay A type 4 module LED display



- Type A (EN/IEC 60947-2 annex B and M)
- Selectable set point and delay
- Alarm + pre-alarm or alarm function with 2 SPDT contacts
- Selectable filter for harmonic components
- Instantaneous display $I_{\Delta n}$
- Automatic permanent test
- "No trip" TEST (without output relay tripping)
- Manual or automatic RESET
- RS485 communication

Cat. Nos.	DELTA D4-h		
	$I_{\Delta n}$ (A)	V_n	Pre alarm
RDD42130	0.03...30A	230Vac	20/30/40/50% $I_{\Delta n}$
RDD421H0		20...150Vdc+48Vac	
RDD42131		230Vac	
RDD421H1		20...150Vdc+48Vac	

Technical features

TECHNICAL NOTES	NT897
INPUT	
Reference specification:	EN60947-2 IEC60947-2
Connection:	low voltage lines, with series TD transformer
Waveform $I_{\Delta n}$:	sinusoidal (type AC) or chopped pulsating with superimposed d.c. (type A) according to EN60947-2 (annex B and M) IEC60947-2
Rated frequency f_n :	50Hz
Working frequency:	47...63Hz
SET UP	
Current set point $I_{\Delta n}$:	selectable by 7-position potentiometer, 3 ranges $\times 1 \times 10 \times 100$
Ranges $I_{\Delta n}$:	0.03-0.05-0.075-0.1-0.15-0.2-0.3 ($\times 1 \times 10 \times 100$)
Non-operating residual current :	0,5 $I_{\Delta n}$
Adjustable range t:	0 - 0,15 - 0,25 - 0,5 - 1 - 2,5 - 5 seconds
SIGNALING	
Display:	red LED, 1000 points (3 digits)
Display:	instantaneous value $I_{\Delta n}$ / threshold value $I_{\Delta n}$ / delay Δt
Alarm intervention:	message "ALL" + relay switching 1
Ring current transformer-relay connection failure:	message "Ct" + relay 1 switching
CONTROL	
Manual test:	it verifies the perfect working of the residual current relay
Local:	front key
Automatic continuous test:	it verifies the integrity of the connection between relay and ring core
ALARM	
TRIP state memorization	"ALL" message + relay self-retaining 1
Manual reset:	local or remote
Local manual reset:	Reset key
Remote manual reset:	external contact closing
Pre-alarm:	20 - 30 - 40 - 50% selected $I_{\Delta n}$
Inhibited reset with persistent residual current:	> 50% $I_{\Delta n}$
OUTPUT	
Relay:	2 SPDT contacts
Contact range:	5A 250Vac $\cos\phi$ 1 - 3A 250Vac $\cos\phi$ 0,4 - 5A 30Vdc
RS485 COMMUNICATION	
Standard:	RS485 - 3-wire
Protocol:	ModBus RTU / TCP
Baud rate	4800...38400 bit/s
AUXILIARY SUPPLY	
Rated value U_{aux} :	230V-48V
Tolerance:	0,85...1,1 U_{aux} 40...60V (U_{aux} 48V)
Rated frequency:	50Hz
Tolerance:	47...63Hz
Rated burden:	$\leq 2,5VA$
Immunity to short interruption of supply voltage up to 150ms (Rated U_{aux})	
ENVIRONMENTAL CONDITIONS	
Nominal temperature range:	-5...50°C
Limit temperature range for storage:	-40...70°C
Suitable for tropical climates	yes
Max. power dissipation :	$\leq 3W$ *
MECHANICAL FEATURES	
Housing:	4 module DIN 43880 (35mm)
Connections:	screw terminals for cable up to 4mm ²
Housing material:	self-extinguishing polycarbonate
Protection degree (EN/IEC 60529):	IP40 front frame, IP20 terminals

* for switchboard thermal calculation

Wiring diagrams

DELTA D4-H

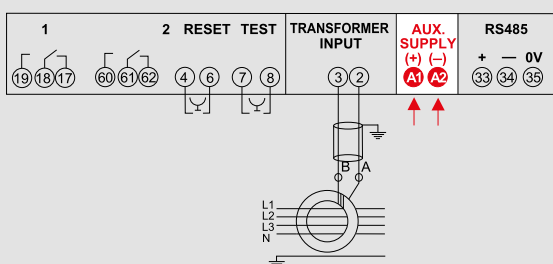

Residual current relay

Residual current relay for public lighting and traffic light plants



Use in unattended environments (public lighting, traffic lights plants)
 Automatic reset (max.3 attempts) in the event of transient ground fault
 Instantaneous ($t = 0$) at $I_{\Delta n}$ 30mA
 Selectable set point: 30mA...30A (19 ranges)
 Instantaneous display as percentage of $I_{\Delta n}$
 Filter for harmonics, field-selectable
 Field-selectable negative or positive security (fail safe)
 Automatic permanent test

Cat. Nos.	DELTA D4-I		
	$I_{\Delta n}$ (A)	V_n	t (s)
RD2B213B	0.03...30A	230Vac	0-0.06-0.15-0.31-0.5-1-4.5

Technical features

TECHNICAL NOTES	NT748
INPUT	
Reference specification:	EN60947-2 IEC60947-2
Connection:	low voltage lines, with series TD transformer
Waveform $I_{\Delta n}$:	sinusoidal (type AC) or chopped pulsating with superimposed d.c. (type A) according to EN60947-2 (annex B and M) IEC60947-2
Rated frequency f_n :	50Hz
Working frequency:	47...63Hz
SET UP	
Current set point $I_{\Delta n}$:	selectable by 7-position potentiometer, 3 ranges x1-x10-x00
Ranges $I_{\Delta n}$:	0.03-0.05-0.075-0.1-0.15-0.2-0.3 (x1-x10-x100)
Non-operating residual current :	0,5 $I_{\Delta n}$
Adjustable range t:	0 - 0,15 - 0,25 - 0,5 - 1 - 2,5 - 5 seconds
R2 relay (60-61-62) has a 0,4 second extra delay compared to the value of the selected intervention delay of the R1 relay (17-18-19). Selecting the intervention threshold on position 0,03 the intervention delay is automatically excluded, independently of position of range selector (x1/10/100).	
SIGNALING	
Power ON:	green LED "ON"
Instantaneous value $I_{\Delta n}$:	4 yellow LED's, 20-30-40-50% of set $I_{\Delta n}$ value
Alarm intervention:	red LED "TRIP" + relay switching
Ring current transformer-relay connection failure:	red LED "TRIP" blinking + relay switching
CONTROL	
Manual test:	it verifies the perfect working of the residual current relay
Local:	front key
Automatic continuous test:	it verifies the integrity of the connection between relay and ring core
ALARM	
The alarm reset can be manually or automatically made (selectable)	
Reset manual:	local or remote
Local:	front key
Remote:	external contact closing
Inhibited reset with persistent residual current:	> 50% $I_{\Delta n}$
OUTPUT	
Relay:	2 SPDT contacts
Contact range:	5A 250Vac $\cos\phi$ 1 - 3A 250Vac $\cos\phi$ 0,4 - 5A 30Vdc
Negative security (normally de-energised relay) or positive security fail safe (normally energised relay) selectable by dip switch R2 (60-61-62) is always normally de-energised relay	
AUXILIARY SUPPLY	
Rated value U_{aux} :	230V
Tolerance:	0,85...1,1 U_{aux}
Rated frequency:	50Hz
Tolerance:	47...63Hz
Rated burden:	\leq 2,5VA
Immunity to short interruption of supply voltage up to 150ms (Rated U_{aux})	
ENVIRONMENTAL CONDITIONS	
Nominal temperature range:	-5...50°C
Limit temperature range for storage:	-40...70°C
Suitable for tropical climates	yes
Max. power dissipation :	\leq 2W *
MECHANICAL FEATURES	
Housing:	4 module DIN 43880 (35mm)
Connections:	screw terminals for cable up to 4mm ²
Housing material:	self-extinguishing polycarbonate
Protection degree (EN/IEC 60529):	IP40 front frame, IP20 terminals

* for switchboard thermal calculation

Wiring diagrams

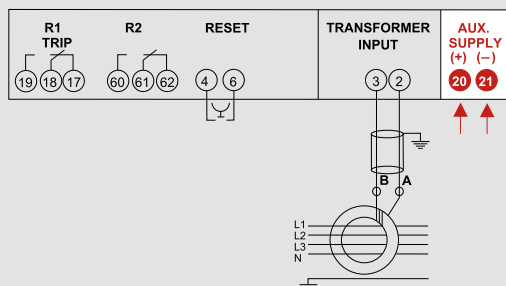

Residual current relay

Residual current relay A type flush mounting 48 x 48 cm



Istantaneous ($t = 0$) at $I_{\Delta n}$ 30mA
 Selectable set point: 30mA...30A (19 ranges)
 Field-selectable negative or positive security (fail safe)
 Automatic permanent test
 Manual or automatic reset (3 restart attempts)

Cat. Nos.		DELTA 48-s		$I_{\Delta n}$ (A)	V_n	t (s)
1 alarm contact	2 alarm contacts					
RD1DF11B	RD1D211B			0.03...30A	24Vac	0-0.15-
RD1DF12B	RD1D212B				115Vac	0.25-0.5-
RD1DF13B	RD1D213B				230Vac	1-2.5-5
RD1DF15B	RD1D215B				400Vac	
RD1DF1HB	RD1D21HB				20...150Vdc+ 48Vac	

Technical features

MODEL	(RD1DF...)	(RD1D2...)
TECHNICAL NOTES	NT556	NT711
INPUT		
Reference specification	EN60947-2 IEC60947-2	
Connection	low voltage lines, with series TD transformer	
Waveform $I_{\Delta n}$	sinusoidal (type AC) or chopped pulsating with superimposed dc (type A) according to EN60947-2 (annex B and M) IEC60947-2	
Rated frequency f_n	50Hz	
Working frequency	47...63Hz	
SET UP		
Current set point $I_{\Delta n}$	selectable by 7-position potentiometer, 3 ranges $\times 1 - \times 10 - \times 100$	
Ranges $I_{\Delta n}$	0.03 - 0.05 - 0.075 - 0.1 - 0.15 - 0.2 - 0.3 ($\times 1 - \times 10 - \times 100$)	
Non-operating residual current	0.5 $I_{\Delta n}$	
Adjustable intervention time t	0-0,15-0,25-0,5-1-2,5-5s	
SIGNALING AND ALARM		
Power ON	green LED "ON"	
Alarm intervention	red LED "TRIP" + relay switching	
Ring current transformer-relay connection failure	red LED "TRIP" blinking + relay switching	
TRIP state memorization	1 red LED "TRIP" + relay self-retaining	
Reset	manual or automatic, selectable by dip switch	
Local manual	front key	
Remote manual	external contact closing	
Automatic	3 restart attempts (1 each 60 seconds)	
Inhibited reset with persistent residual current	> 50% $I_{\Delta n}$	
OUTPUT		
Relay	1 SPDT contact or 1 SPDT contact + 1 SPST contact	
Contact range	5A 250Vac $\cos\phi$ 1 - 3A 250Vac $\cos\phi$ 0.4 - 5A 30Vdc	

AUXILIARY SUPPLY	
Rated value U_{aux}	24V - 48V - 115V - 230V - 240V - 400V
Tolerance	0,85...1,1 U_{aux} - 40...60V (U_{aux} 48V)
Rated frequency	50Hz (47...63Hz)
Rated burden	$\leq 2,5VA$
Rated value U_{aux}	20...150Vdc
Protected against incorrect polarity	yes
Rated burden	$\leq 2,5W$
Immunity to short interruption of supply voltage up to 300ms (Rated U_{aux})	

TESTS FOR ELECTROMAGNETIC COMPATIBILITY	
Emission/Immunity tests according to	EN / IEC 60947-2

ENVIRONMENTAL CONDITIONS	
Nominal temperature range	-5...50°C
Limit temperature range for storage	-40...70°C
Suitable for tropical climates	yes
Max. power dissipation	$\leq 2W$ *

MECHANICAL FEATURES	
Housing	flush mounting (panel cutout 45x45mm)
Depth	102mm
Front frame	48x48 mm (52x52 with IP54 option)
Connections	fast-ons 6,3 x 0,8 mm
Housing material	self-extinguishing polycarbonate
Protection degree (EN / IEC 60529)	IP40 front frame, IP20 terminals (option kit for IP54 front frame protection)

* for switchboard thermal calculation

Wiring diagrams

1 alarm contact

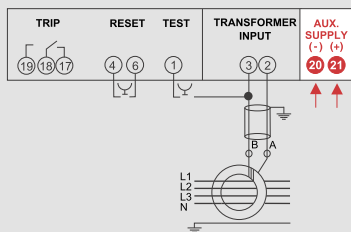

2 alarm contacts

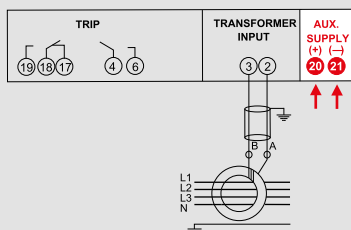

Residual current relay

Residual current relay A type flush mounting 72 x 72 cm



- Instantaneous ($t = 0$) at $I_{\Delta n}$ 30mA
- Selectable set point 30mA...30A (19 ranges)
- Instantaneous display as percentage of $I_{\Delta n}$
- Pre-alarm threshold
- Field-selectable negative or positive security (fail safe)
- Automatic permanent test
- Manual or automatic reset (3 restart attempts)

Cat. Nos.		DELTA 72-s		
2 contact (alarm + pre-alarm)	2 contact (alarm or alarm + pre-alarm)	$I_{\Delta n}$ (A)	V_n	t (s)
RD1EP11B	RD1E211B	0.03...30A	24Vac	0-0.15- 0.25-0.5- 1-2.5-5
RD1EP12B	RD1E212B		115Vac	
RD1EP13B	RD1E213B		230Vac	
RD1EP15B	RD1E215B		400Vac	
RD1EP1HB	RD1E21HB		20...150Vdc+ 48Vac	

Technical features

MODEL	(RD1EP...)	(RD1E2...)
TECHNICAL NOTES	NT552	NT692
INPUT		
Reference specification	EN60947-2 IEC60947-2	
Connection	low voltage lines, with series TD transformer	
Waveform $I_{\Delta n}$	sinusoidal (type AC) or chopped pulsating with superimposed dc (type A) according to EN60947-2 (annex B and M) IEC60947-2	
Rated frequency f_n	50Hz	
Working frequency	47...63Hz	
SET UP		
Current set point $I_{\Delta n}$	selectable by 7-position potentiometer, 3 ranges x1 - x10 - x100	
Ranges $I_{\Delta n}$	0.03 - 0.05 - 0.075 - 0.1 - 0.15 - 0.2 - 0.3 (x1 - x10 - x100)	
Non-operating residual current	0.5 $I_{\Delta n}$	
Adjustable Intervention time t	0-0,15-0,25-0,5-1-2,5-5s	
SIGNALING AND ALARM		
Power ON	green LED "ON"	
Instantaneous value $I_{\Delta n}$	4 yellow LED's, 20 - 30 - 40 - 50% of set $I_{\Delta n}$ value	
Alarm intervention	red LED "TRIP" + relay switching	
Ring current transformer-relay connection failure	red LED "TRIP" blinking + relay switching	
Pre-alarm	50% $I_{\Delta n}$ relay switching	
TRIP state memorization	1 red LED "TRIP" + relay self-retaining	
Reset	manual or automatic, selectable by dip switch	
Local manual	front key	
Remote manual	external contact closing	
Automatic	3 restart attempts (1 each 60 seconds)	
Inhibited reset with persistent residual current	> 50% $I_{\Delta n}$	
OUTPUT		
50% $I_{\Delta n}$ relay	1 SPDT contact (Negative security)	
Trip relay	1 SPDT contact	
Contact range	5A 250Vac $\cos\phi$ 1 - 3A 250Vac $\cos\phi$ 0.4 - 5A 30Vdc	
AUXILIARY SUPPLY		
Rated value U_{aux}	24V - 48V - 115V - 230V - 240V - 400V	
Tolerance	0,85...1,1 U_{aux} - 40...60V (U_{aux} 48V)	
Rated frequency	50Hz (47...63Hz)	
Rated burden	$\leq 2.5VA$	
Rated value U_{aux}	20...150Vdc	
Protected against incorrect polarity	yes	
Rated burden	$\leq 2.5W$	
Immunity to short interruption of supply voltage up to 300ms (Rated U_{aux})		
TESTS FOR ELECTROMAGNETIC COMPATIBILITY		
Emission/Immunity tests according to	EN / IEC 60947-2	
ENVIRONMENTAL CONDITIONS		
Nominal temperature range	-5...50°C	
Limit temperature range for storage	-40...70°C	
Suitable for tropical climates	yes	
Max. power dissipation	$\leq 2W$ *	
MECHANICAL FEATURES		
Housing	flush mounting (panel cutout 68x68mm)	
Depth	75mm	
Front frame	72x72 mm	
Connections	fast-ons 6,3 x 0,8 mm	
Housing material	self-extinguishing polycarbonate	
Protection degree (EN / IEC 60529)	IP40 front frame, IP20 terminals	

* for switchboard thermal calculation

Wiring diagrams

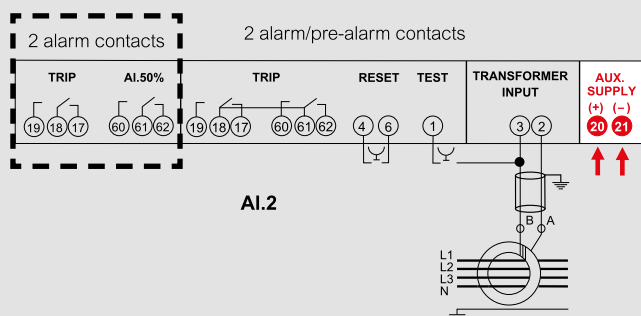

Residual current relay

Residual current relay A type flush mounting 72 x 72 cm LED display



- Instantaneous ($t = 0$) at $I_{\Delta n}$ 30mA
- Selectable set point 30mA...30A (19 ranges)
- Instantaneous display of $I_{\Delta n}$
- Alarm + pre-alarm or alarm with 2 contacts
- Field-selectable negative or positive security (fail safe)
- Automatic permanent test

Cat. Nos.	DELTA 72-h		
	$I_{\Delta n}$ (A)	V_n	t (s)
RD3E211B	0.03...30A	24Vac	0-0.15-0.25- 0.5-1-2.5-5
RD3E212B		115Vac	
RD3E217B		230Vac	
RD3E218B		400Vac	
RD3E21HB		20...150Vdc + 48Vac	

Technical features

TECHNICAL NOTES	NT649
INPUT	
Reference specification	EN60947-2 IEC60947-2
Connection	low voltage lines, with series TD transformer
Waveform $I_{\Delta n}$	sinusoidal (type AC) or chopped pulsating with superimposed dc (type A) according to EN60947-2 (annex B and M) IEC60947-2
Rated frequency f_n	50Hz
Working frequency	47...63Hz
SET UP	
Current set point $I_{\Delta n}$	selectable by 7-position potentiometer, 3 ranges $\times 1 - \times 10 - \times 100$
Ranges $I_{\Delta n}$	0.03 - 0.05 - 0.075 - 0.1 - 0.15 - 0.2 - 0.3 ($\times 1 - \times 10 - \times 100$)
Non-operating residual current	0.5 $I_{\Delta n}$
Adjustable Intervention time t	0-0,15-0,25-0,5-1-2,5-5s
SIGNALING AND ALARM	
Power ON	green LED "ON"
Instantaneous value $I_{\Delta n}$	4 yellow LED's, 20 - 30 - 40 - 50% of set $I_{\Delta n}$ value
Alarm intervention	"AL" message blinking + "FAULT" relay switching
Ring current transformer-relay connection failure	"CT" message blinking + "FAULT" relay switching
Pre-alarm	"ALARM" relay switching
Manual test	"AL" message fixed + "FAULT" relay switching
Instantaneous value $I_{\Delta n}$	1000 points display (3 digit)
Display type	red LED, 7 segments
Digit height	10mm
Accuracy	$\pm 5\% + 1$ digit (referred to measuring full scale)
ELR measuring range	10...100% selected $I_{\Delta n}$
OUTPUT	
Alarm relay (FAULT) + pre-alarm (ALARM)	FAULT relay 1 SPDT contact ALARM relay 1 SPST contact
Alarm relay with 2 contacts	1 SPDT contacts + 1 SPST contact
Contact range	5A 250Vac $\cos\phi$ 1 - 3A 250Vac $\cos\phi$ 0,4 - 5A 30Vdc
AUXILIARY SUPPLY	
Rated value U_{aux}	24V - 48V - 115V - 230V - 240V - 400V
Tolerance	0,85...1,1 U_{aux} - 40...60V (U_{aux} 48V)
Rated frequency	50Hz (47...63Hz)
Rated burden	$\leq 4VA$
Rated value U_{aux}	20...150Vdc
Protected against incorrect polarity	yes
Rated burden	$\leq 4W$
Immunity to short interruption of supply voltage up to 150ms (Rated U_{aux})	
TESTS FOR ELECTROMAGNETIC COMPATIBILITY	
Emission/Immunity tests according to	EN / IEC 60947-2
ENVIRONMENTAL CONDITIONS	
Nominal temperature range	-25...55°C
Limit temperature range for storage	-40...85°C
Suitable for tropical climates	yes
Max. power dissipation	$\leq 2.5W$ *
MECHANICAL FEATURES	
Housing	flush mounting (panel cutout 68x68mm)
Depth	81.8mm
Front frame	72x72 mm
Connections	extractable terminals, screw terminals for cable up to 4mm ²
Housing material	self-extinguishing polycarbonate
Protection degree (EN / IEC 60529)	IP40 front frame, IP20 terminals

* for switchboard thermal calculation

Wiring diagrams

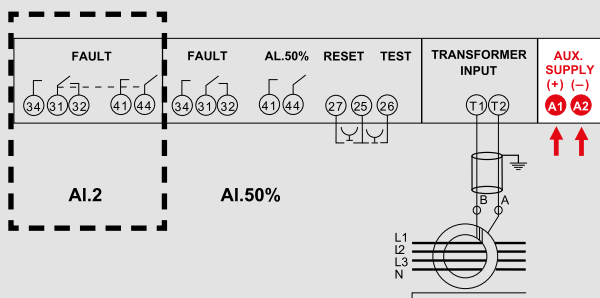

Residual current relay

Residual current relay A type flush mounting 72 x 72 cm with powered filter



Heavy industrial applications with distorted current waveforms:
inverters, variable speed drives, rectifiers, frequency regulators
Filter for harmonics

It cannot be used to protect people

Selectable set point 50mA...30A (18 ranges)

Instantaneous display as percentage of $I_{\Delta n}$

Field-selectable negative or positive security (fail safe)

Automatic permanent test

Alarm relay + pre-alarm or alarm relay with double exchange

Cat. Nos.	DELTA 72-f		
	$I_{\Delta n}$ (A)	V_n	t (s)
RD2E211B	0.05...30A	24Vac	0-0.15-0.25- 0.5-1-2.5-5
RD2E212B		115Vac	
RD2E213B		230Vac	
RD2E215B		400Vac	
RD2E21HB		20...150Vdc+ 48Vac	

Technical features

TECHNICAL NOTES	NT745
INPUT	
Reference specification	EN60947-2 IEC60947-2
Connection	low voltage lines, with series TD transformer
Waveform $I_{\Delta n}$	sinusoidal (type AC) or chopped pulsating with superimposed dc (type A) according to EN60947-2 (annex B and M) IEC60947-2
Rated frequency f_n	50Hz
Working frequency	47...63Hz
SET UP	
Current set point $I_{\Delta n}$	selectable by 6-position potentiometer, 3 ranges x1 - x10 - x100
Ranges $I_{\Delta n}$	0.05-0, 0.75-0.1-0.15-0.2-0.3 (x1-x10-x100)
Non-operating residual current	0.5 $I_{\Delta n}$
Adjustable Intervention time t	0-0,15-0,25-0,5-1-2,5-5s
SIGNALING AND ALARM	
Power ON	green LED "ON"
Instantaneous value $I_{\Delta n}$	4 yellow LED's, 20 - 30 - 40 - 50% of set $I_{\Delta n}$ value
Alarm intervention	red LED "TRIP" + "TRIP" relay switching
Ring current transformer-relay connection failure	red LED "TRIP" blinking + "TRIP" relay switching
Pre-alarm	50% $I_{\Delta n}$ relay switching
Manual test	it verifies the perfect working of the residual current relay
Local	front key
Remote	by external contact closing (Not available with dc supply and Uaux 48Vac)
Automatic continuous test	verifies the integrity of the connection between relay and ring core
OUTPUT	
Alarm relay with double exchange (AI.2)	2 SPDT contacts
Alarm + pre-alarm (AI.50%)	1 SPDT contact
50% $I_{\Delta n}$ relay	SPDT contact (negative security)
Contact range	5A 250Vac $\cos\phi$ 1 - 3A 250Vac $\cos\phi$ 0.4 - 5A 30Vdc
AUXILIARY SUPPLY	
Rated value U_{aux}	24V - 48V - 115V - 230V - 240V - 400V
Tolerance	0,85...1,1 U_{aux} - 40...60V (U_{aux} 48V)
Rated frequency	50Hz (47...63Hz)
Rated burden	\leq 2,5VA
Rated value U_{aux}	20...150Vdc
Protected against incorrect polarity	yes
Rated burden	\leq 2,5W
Immunity to short interruption of supply voltage up to 150ms (Rated U_{aux})	
TESTS FOR ELECTROMAGNETIC COMPATIBILITY	
Emission/Immunity tests according to	EN / IEC 60947-2
ENVIRONMENTAL CONDITIONS	
Nominal temperature range	-5...50°C
Limit temperature range for storage	-40...70°C
Suitable for tropical climates	yes
Max. power dissipation	\leq 2W *
MECHANICAL FEATURES	
Housing	flush mounting (panel cutout 68x68mm)
Depth	75mm
Front frame	72x72mm (75x75 mm with IP54 option)
Connections	extractable terminals, screw terminals for cable up to 4mm ²
Housing material	self-extinguishing polycarbonate
Protection degree (EN / IEC 60529)	IP40 front frame, IP20 terminals

* for switchboard thermal calculation

Wiring diagrams

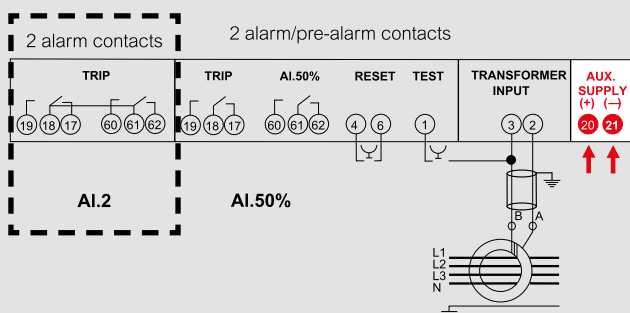

Residual current relay

Residual current relay A type flush mounting 96 x 96 cm



- Instantaneous ($t = 0$) at $I_{\Delta n}$ 30mA
- Selectable set point 30mA...30A (19 ranges)
- Instantaneous display as percentage of $I_{\Delta n}$
- Field-selectable negative or positive security (fail safe)
- Automatic permanent test
- Alarm relay + pre-alarm or alarm relay with double exchange

Cat. Nos.	DELTA 96-s		
	$I_{\Delta n}$ (A)	V_n	t (s)
RD1G211B	0.03...30A	24Vac	0-0.15-0.25- 0.5-1-2.5-5
RD1G212B		115Vac	
RD1G213B		230Vac	
RD1G215B		400Vac	
RD1G215B		400Vac	
RD1G21HB		20...150Vdc+ 48Vac	

Technical features

TECHNICAL NOTES	NT691
INPUT	
Reference specification	EN60947-2 IEC60947-2
Connection	low voltage lines, with series TD transformer
Waveform $I_{\Delta n}$	sinusoidal (type AC) or chopped pulsating with superimposed dc (type A) according to EN60947-2 (annex B and M) IEC60947-2
Rated frequency f_n	50Hz
Working frequency	47...63Hz
SET UP	
Current set point $I_{\Delta n}$	selectable by 7-position potentiometer, 3 ranges x1 - x10 - x100
Ranges $I_{\Delta n}$	0.03-0.05-0.075-0.1-0.15-0.2-0.3 (x1-x10-x100)
Non-operating residual current	0.5 $I_{\Delta n}$
Adjustable Intervention time t	0-0,15-0,25-0,5-1-2,5-5s
SIGNALING AND ALARM	
Power ON	green LED "ON"
Instantaneous value $I_{\Delta n}$	4 yellow LED's, 20 - 30 - 40 - 50% of set $I_{\Delta n}$ value
Alarm intervention	red LED "TRIP" + "TRIP" relay switching
Ring current transformer-relay connection failure	red LED "TRIP" blinking + "TRIP" relay switching
Pre-alarm	50% $I_{\Delta n}$ relay switching
Manual test	it verifies the perfect working of the residual current relay
Local	front key
Remote	by external contact closing (Not available with dc supply and Uaux 48Vac)
Automatic continuous test	verifies the integrity of the connection between relay and ring core
OUTPUT	
Alarm relay with double exchange (AI.2)	2 SPDT contacts
Alarm + pre-alarm (AI.50%)	1 SPDT contact
50% $I_{\Delta n}$ relay	SPDT contact (negative security)
Contact range	5A 250Vac $\cos\phi$ 1 - 3A 250Vac $\cos\phi$ 0.4 - 5A 30Vdc
AUXILIARY SUPPLY	
Rated value U_{aux}	24V - 48V - 115V - 230V - 240V - 400V
Tolerance	0,85...1,1 U_{aux} - 40...60V (U_{aux} 48V)
Rated frequency	50Hz (47...63Hz)
Rated burden	$\leq 2.5VA$
Rated value U_{aux}	20...150Vdc
Protected against incorrect polarity	yes
Rated burden	$\leq 2.5W$
Immunity to short interruption of supply voltage up to 150ms (Rated U_{aux})	
TESTS FOR ELECTROMAGNETIC COMPATIBILITY	
Emission/Immunity tests according to	EN / IEC 60947-2
ENVIRONMENTAL CONDITIONS	
Nominal temperature range	-5...50°C
Limit temperature range for storage	-40...70°C
Suitable for tropical climates	yes
Max. power dissipation	$\leq 2W$ *
MECHANICAL FEATURES	
Housing	flush mounting (panel cutout 92x92mm)
Depth	80mm
Front frame	96x96mm (75x75 mm with IP54 option)
Connections	fast-ons 6,3x0,8mm
Housing material	self-extinguishing polycarbonate
Protection degree (EN / IEC 60529)	IP40 front frame, IP20 terminals

* for switchboard thermal calculation

Wiring diagrams

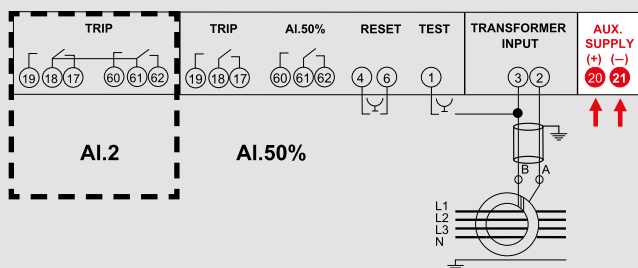

Residual current relay

Residual current relay A type flush mounting 96 x 96 cm with powered filter



Heavy industrial applications with distorted current waveforms:
inverters, variable speed drives, rectifiers, frequency regulators
Filter for harmonics

- It cannot be used to protect people
- Selectable set point 50mA...30A (18 ranges)
- Instantaneous display as percentage of $I_{\Delta n}$
- Field-selectable negative or positive security (fail safe)
- Automatic permanent test
- Alarm relay + pre-alarm or alarm relay with double exchange

Cat. Nos.	DELTA 96-f		
	$I_{\Delta n}$ (A)	V_n	t (s)
RD2G211B	0.05...30A	24Vac	0-0.15-0.25- 0.5-1-2.5-5
RD2G212B		115Vac	
RD2G213B		230Vac	
RD2G215B		400Vac	
RD2G215B		20...150Vdc+ 48Vac	
RD2G21HB			

Technical features

TECHNICAL NOTES	NT746
INPUT	
Reference specification	EN60947-2 IEC60947-2
Connection	low voltage lines, with series TD transformer
Waveform $I_{\Delta n}$	sinusoidal (type AC) or chopped pulsating with superimposed dc (type A) according to EN60947-2 (annex B and M) IEC60947-2
Rated frequency f_n	50Hz
Working frequency	47...63Hz
SET UP	
Current set point $I_{\Delta n}$	selectable by 6-position potentiometer, 3 ranges $\times 1 - \times 10 - \times 100$
Ranges $I_{\Delta n}$	0.05-0. 075-0.1-0.15-0.2-0.3 ($\times 1-\times 10-\times 100$)
Non-operating residual current	0.5 $I_{\Delta n}$
Adjustable Intervention time t	0-0,15-0,25-0,5-1-2,5-5s
SIGNALING AND ALARM	
Power ON	green LED "ON"
Instantaneous value $I_{\Delta n}$	4 yellow LED's, 20 - 30 - 40 - 50% of set $I_{\Delta n}$ value
Alarm intervention	red LED "TRIP" + "TRIP" relay switching
Ring current transformer-relay connection failure	red LED "TRIP" blinking + "TRIP" relay switching
Pre-alarm	50% $I_{\Delta n}$ relay switching
Manual test	it verifies the perfect working of the residual current relay
Local	front key
Remote	by external contact closing (Not available with dc supply and Uaux 48Vac)
Automatic continuous test	verifies the integrity of the connection between relay and ring core
OUTPUT	
Alarm relay with double exchange (AI.2)	2 SPDT contacts
Alarm + pre-alarm (AI.50%)	1 SPDT contact
50% $I_{\Delta n}$ relay	SPDT contact (negative security)
Contact range	5A 250Vac $\cos\phi$ 1 - 3A 250Vac $\cos\phi$ 0,4 - 5A 30Vdc
AUXILIARY SUPPLY	
Rated value U_{aux}	24V - 48V - 115V - 230V - 240V - 400V
Tolerance	0,85...1,1 U_{aux} - 40...60V (U_{aux} 48V)
Rated frequency	50Hz (47...63Hz)
Rated burden	$\leq 2.5VA$
Rated value U_{aux}	20...150Vdc
Protected against incorrect polarity	yes
Rated burden	$\leq 2.5W$
Immunity to short interruption of supply voltage up to 150ms (Rated U_{aux})	
TESTS FOR ELECTROMAGNETIC COMPATIBILITY	
Emission/Immunity tests according to	EN / IEC 60947-2
ENVIRONMENTAL CONDITIONS	
Nominal temperature range	-5...50°C
Limit temperature range for storage	-40...70°C
Suitable for tropical climates	yes
Max. power dissipation	$\leq 2W$ *
MECHANICAL FEATURES	
Housing	flush mounting (panel cutout 92x92mm)
Depth	80mm
Front frame	96x96mm (75x75 mm with IP54 option)
Connections	fast-ons 6,3x0,8mm
Housing material	self-extinguishing polycarbonate
Protection degree (EN / IEC 60529)	IP40 front frame, IP20 terminals

* for switchboard thermal calculation

Wiring diagrams

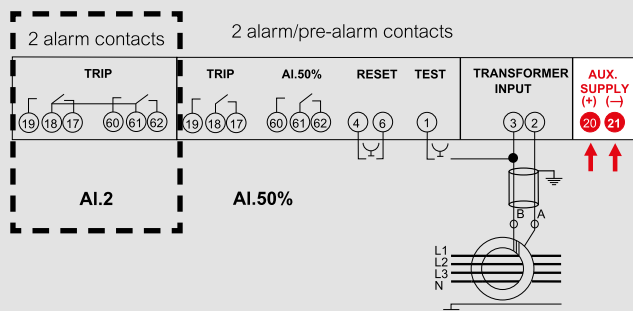

Residual current relay

Transformers for residual current relay open and close core



TDG...



TDA...

Cat. Nos.		DEL		
	I _{dn} (A)	Inside diameter (mm)	Core Type	
TDGA2	0.03	28	Closed	
TDGB2	0.03	35	Closed	
TDGH2	0.03	60	Closed	
TDGC2	0.03	80	Closed	
TDGD2	0.1	110	Closed	
TDGE2	0.3	140	Closed	
TDFG2	0.3	210	Closed	

ATADIN01 Accessory for transformers mounting on DIN35 rail

Cat. Nos.		DEL-A		
	I _{dn} (A)	Inside diameter (mm)	Core Type	
TDAA2	0.5	110	Open	
TDAB2	0.5	150	Open	
TDAC2	1	300	Open	

Technical features

TECHNICAL NOTES	NT641
SPECIFICATIONS	
Primary/secondary measuring ratio	1/700
Primary circuit	conductors of line to be protected that cross toroid hole
Test current corresponding to 6 In	I _{max} (shown values are valid only for conductors passing exactly in the middle of toroid).
I _{th} short circuit thermal current	90kA according to EN/IEC 61869-1, 61869-2
INSULATION	
Rated voltage of the monitored circuit U _n	720V (phase-neutral)
Rated power frequency withstand voltage	3kV (50Hz / 1min)
Rated impulse withstand voltage U _{imp}	8kV 1,2/50μs
ENVIRONMENTAL CONDITIONS	
Nominal range temperature(EN/IEC 60947-2)	-5÷40°C
Limit temperature range for storage	-40 ÷ 70°C
Suitable for tropical climates	yes
MECHANICAL FEATURES	
Connections	screw terminals with protection terminal cover (sealable)
Housing material	PC V0 self-extinguishing according to UL94
Mounting	screw type

Dimensions

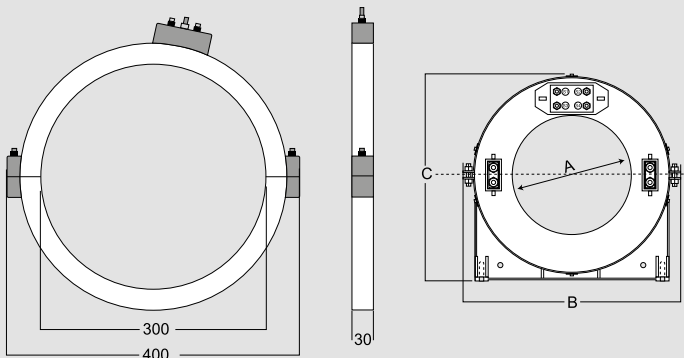

Model	A	B	C	Weight
TDAA2	110	235	219	250g
TDAB2	150	275	259	300g

Dimensions

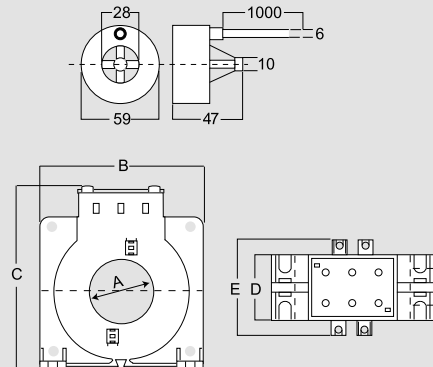

Dim. (mm)	A	B	C	D	E	Weight
TDGB2	35	92	113	36	56	250g
TDGH2	60	105	138	36	56	300g
TDGC2	80	125	160	36	56	350g
TDGD2	110	165	198	36	56	500g
TDGE2	140	200	234	36	56	700g
TDFG2	210	290	323	44	64	1200g
TDS5...	80	125	160	36	56	400g

Residual current relay

Summing ring current transformer for differential protection with measuring CT transformer



Cat. Nos.	DEL		
	I _{dn} (A)	Diameter (mm)	Core Type
TDS5C100	100/5	80	Closed
TDS5C150	150/5	80	Closed
TDS5C250	250/5	80	Closed
TDS5C400	400/5	80	Closed
TDS5C500	500/5	80	Closed
TDS5C600	600/5	80	Closed
TDS5C800	800/5	80	Closed
TDS5D100	1000/5	80	Closed
TDS5D120	1200/5	80	Closed
TDS5D125	1250/5	80	Closed
TDS5D150	1500/5	80	Closed
TDS5D160	1600/5	80	Closed
TDS5D200	2000/5	80	Closed
TDS5D250	2500/5	80	Closed
TDS5D300	3000/5	80	Closed
TDS5D320	3200/5	80	Closed
TDS5D400	4000/5	80	Closed
TDS5D500	5000/5	80	Closed

Technical features

APPLICATION

If problems with insulation or with cable or bar dimensions for the line to be protected don't allow to use ring current transformers (max. hole diameter 300mm) it is possible to use instrument current transformers with 5A secondary winding and same primary currents, accuracy class 0,5 or 1.

CHOICE OF TRANSFORMER

Transformer ratio according to the connected instrument current transformer ratio. In case of connection with instrument current transformer with ratio higher than 400/5A, the values of intervention current I_{Δn} selectable on the earth leakage relay are multiplied x10.

CONNECTION TDS5 - EARTH LEAKAGE RELAY

It should be preferably carried out with shielded cable; this precaution is of great importance when you mount high-sensitivity earth leakage relay (I_{Δn} ≤ 0,1A). Besides you have to pay particular attention to the distance between the ring current transformer and the relay (which must be as short as possible) and the closeness of power conductors or other devices which can cause noises on the system. If shielded cables cannot be used, it is advisable to twist the TDS5-relay connecting cables.

TECHNICAL NOTES	NT642
INSULATION	
Insulation voltage rating	0,72kV
A.C. voltage test 3	kV r.m.s. 50Hz / 1min
Considered circuits	measuring windings towards earth
ENVIRONMENTAL CONDITIONS	
Nominal range temperature (EN/IEC 60947-2)	-5...40°C
Limit temperature range for storage	-40...70°C
Suitable for tropical climates	yes
MECHANICAL FEATURES	
Connections	screw terminals
Housing material	self-extinguishing ABS
Mounting	screw type
Weight	400gr.

Dimensions

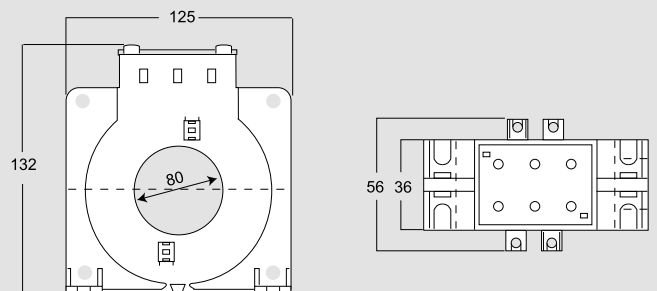

Residual current relay

Switch opening circuit monitoring unit with current launching coil



It guarantees the differential protection reliability by monitoring the release circuit working order of one or two switches with current launching coil. It reports the opening circuit breakdown by displaying the alarm (front LED) and intervention of output relay.

It can be used for all the applications which provide for the use of circuits with current launching coil to monitor its proper working order (for instance security circuits, sound or visual signalling of states of alarm, fire pumps, etc...)

Controlled circuits 1 or 2 (selectable)

Controlled circuit voltage 20...440V ac/dc

Alarm display

Alarm detection with output relay intervention

Cat. Nos.	Delta TCS		
	Vn auxiliary circuits	Vn circuits	Contacts
ARD003	230Vac	20...440Vac/dc	2
ARD00H	20...150Vdc+48Vac	20...440	2

Technical features

TECHNICAL NOTES	NT817
INPUT	
Controlled circuits	1 or 2 selectable
Controlled circuit voltage	20...440V ac/dc
Controlled circuit rated burden	≤ 1mA
SETTING	
Measurement	direct current (DC) or alternating current (AC) circuit
Controlled circuits	1 coil (F1) or 2 coils (F2)
SIGNALLING	
Monitoring (coil not broken down)	green LED "Ok"
Alarm (broken down coil)	red LED "Fault" + relay communication
CONTROL	
Manual test	it verifies the proper working order for monitoring unit and coil circuit
In the F2 function 2 Test keys which allow verifying each single circuit are available	
ALARM	
Delay	≥ 1s
Reset	automatic
Reset delay	≥ 1s
OUTPUT	
Funzione F1 Relay	2 SPDT contacts (R1+R2)
Funzione F2 Relay	1 SPDT contact (R1) + 1 SPDT contact (R2)
Contact range	5A 250Vac cosφ 1 – 3A 250Vac cosφ 0,4 – 5A 30Vdc
Positive security fail safe (normally energised relay)	
AUXILIARY SUPPLY	
Rated value Uaux ac	48 - 230V
Tolerance	0,8...1,1Uaux ac – 40...60V(Uaux ac 48V)
Rated frequency	50Hz
Tolerance	47...63Hz
Rated burden	2,5VA
Rated value Uaux dc	20...150Vdc
Protected against incorrect polarity	yes
Rated burden	2,5W
TESTS FOR ELECTROMAGNETIC COMPATIBILITY	
Emission/Immunity tests according to	EN/IEC 60947-2
ENVIRONMENTAL CONDITIONS	
Nominal temperature range	-10...50°C
Limit temperature range for storage	-40...70°C
Suitable for tropical climates	yes
Max. power dissipation *	≤ 2,5W
MECHANICAL FEATURES	
Housing	4 module DIN 43880 (35mm)
Connections	screw terminals for cable up to 4mm ²
Housing material	self-extinguishing polycarbonate
Protection degree (EN/IEC 60529)	IP40 front frame, IP20 terminals

* for switchboard thermal calculation

Wiring diagrams

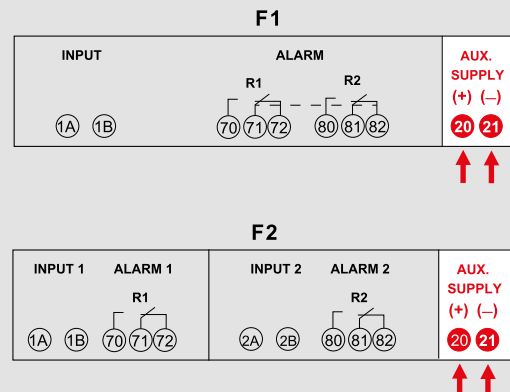

INSULATION RELAYS ISO





Insulation relays

Insulation relay for medical use in IT systems



RIH4001



ARIH001

Cat. Nos. **D4Z - Insulation relay for 230V ac circuit**

Insulation relays for medical use for 230V ac circuit, 1 input from Pt100 + 1 input from CT/5A, 2 contacts, selectable insulation alarm selectable in resistance (R) or impedance (Z) + alarm temperature/power, LED pre-alarm signal, lcd display, output for connection up to 5 remote repeater (Iso Qz), 4 module

RIH4001	Input	Alarm threshold	N° output	Aux
	230Vac	50...500kΩ	2 (alarm + temperature/power)	230Vac

Cat. Nos. **D4Zs - Insulation relay for 24Vac circuit**

Insulation relay for medical use for 24Vac circuit, 1 contact, insulation alarm selectable in resistance (R) or impedance (Z), LED pre-alarm signal, lcd display, output for connection up to 5 remote repeater (Iso Qz), 4 module

RIH4003	Input	Alarm threshold	N° output	Aux
	24Vac	50...500kΩ	1 (alarm + temperature/power)	230Vac

Cat. Nos. **Signal and remote control panel**

Description

Signal and remote control panel for insulation relay Iso D4Z - Iso D4Zs.
Green POWER ON LED
Red FAULT LED
Acoustic warning
TEST and SILENCE button

ARIH001

Technical features

CAT. NOS.	RIH4001	RIH4003	ARIH001
TECHNICAL NOTES	NT688	NT689	NT690
REFERENCE STANDARDS			
Standard	EN/IEC 61557-8 (Attachment A and B) IEC 60364-7-710		CEI 64/8-7 Par. 710.51.2 - 710.4 NFC15-211
DISPLAY			
Display type	LCD		-
Digit height	5mm (2 lines x 8 digit)		-
INPUT			
Voltage Connection	insulation transformer Iso TV		-
Rated voltage Un	230V	24V	-
Rated frequency fn	50Hz		-
Working frequency	47...63Hz		-
Insulation measuring circuit current	≤ 100µA		-
External VT temperature	Pt100 2-wire resistance bulb	-	-
Current connection	by CT/5A	-	-
Rated burden input current	≤ 0,5VA	-	-
Input impedance	> 100kΩ	-	-
Measuring voltage	< 15V	-	-
AUXILIARY SUPPLY			
Rated value Uaux ac	230V		Fed via Iso D4. Panel supply insulated from RI2H auxiliary supply and network. Each insulation monitor RI2H can supply up to 5 repeater. Protection against possible short circuit in the connection between RI2H and AR1
Tolerance	0,9...1,1Uaux		
Rated frequency	± 50%Hz		
Working frequency	47...63Hz		
Rated burden	≤ 6VA - ≤ 4W		
ELECTROMAGNETIC COMPATIBILITY			
Emission tests according to	EN/IEC 61326-2-4	EN/IEC 61557-8	EN/IEC 61557-8
Immunity tests according to	EN/IEC 61326-2-4		
ENVIRONMENTAL CONDITIONS			
Nominal temperature range	-5...55°C		
Limit range for storage and transport	-25...70°C		
Suitable for tropical climates	yes		
Max. power dissipation	≤ 4W *		
MECHANICAL FEATURES			
Housing	4 module DIN 43880 (35mm)	flush mounting (106x71mm)	
Connections	screw terminals for cable up to 4mm ²		screw terminals
Housing material	self-extinguishing makrolon		resin
Protection degree (EN/IEC 60529)	IP54 front frame, IP20 terminals	IP30 front frame	

* for switchboard thermal calculation

Wiring diagrams

RIH4001

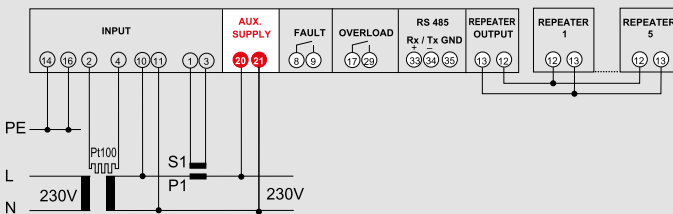

Wiring diagrams

RIH4003

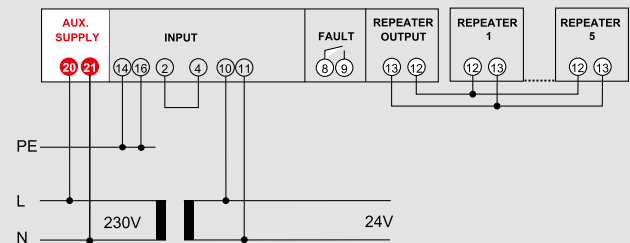

ARIH001

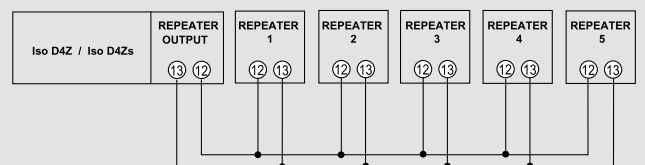

Insulation relays

Insulation transformers for medical use



TI230D500S



TI024D100

Cat. Nos.	Iso TV - Single-phase isolating transformers		
	Insulation single-phase transformer for medical use complete with Pt100 probe, according to Standards EN/IEC 61558-2-15 Used in connection with Iso D4-Z insulation monitor for a continuous control of the insulation towards ground Primary voltage 230V Secondary voltage 230V Rated output 1,5 – 3 – 5 – 7,5 – 10kVA		
TI230D150S TI230D300S TI230D500S TI230D750S TI230E100S	primary V 230Vac	V secondary 230V	Power 1,5kVA 3kVA 5kVA 7.5kVA 10kVA

Cat. Nos.	Iso TV - Single-phase isolating transformers for scalytic lamps		
	Safety single-phase transformer according to Standards EN/IEC 61558-2-6. Used in connection with Iso D4-Zs insulation monitor for a continuous control of the insulation towards ground Primary voltage 230V Secondary voltage 24V Rated output 1kVA		
TI024D100	primary V 230Vac	V secondary 24V	Power 1kVA

Technical features

CAT. NOS.	TI230D...	TI024D100
TECHNICAL NOTES	NT699	NT700
SPECIFICATIONS		
Standard reference	61558-2-15	EN/IEC 61558-2-6
Classification	non-short-circuit proof transformer	
Rated primary voltage Upn	230V	230V
Rated secondary voltage Usn	230V	24V
Rated frequency	50-60Hz	
Efficiency	> 96%	-
Short-circuit voltage	≤ 3% Upn	-
No-load input current	≤ 3% Ipn	-
Inrush current	≤ 12 Ipn	-
Leakage current of the output winding to earth	≤ 0,5mA	-
Transformer temperature measurement	Pt100 resistance bulb, 2-wire	-
ENVIRONMENTAL CONDITIONS		
Nominal temperature range	40°C	
Limit temperature range for storage	-40...85°C	
MECHANICAL FEATURES		
Installation	Fixed, non exposed	
Protection degree (EN/IEC 60529)	IP00 enclosure, IP20 terminals	
Connection	Screw terminals	

Dimensions and weight

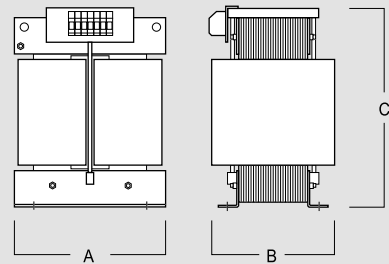

CAT. NOS.	A	B	C	WEIGHT
TI230D150S	200	170	300	~21kg
TI230D300S	250	200	400	~35kg
TI230D500S	250	210	400	~42kg
TI230D750S	280	200	430	~65kg
TI230E100S	280	200	430	~77kg

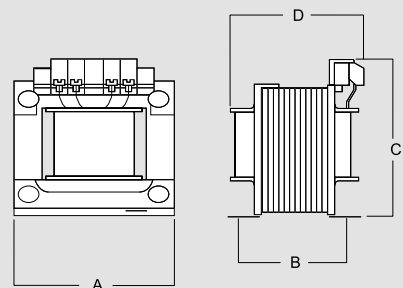

CAT. NOS.	A	B	C	D	WEIGHT
TI024D100	153	140	133	160	~13,5kg

Insulation relays

Insulation relay for industrial use in IT systems



ISO D4

Cat. Nos. **ISO D4 - alternating current**

Insulation relay for IT network in ac, 1 contact, automatic reset, 4 module.
 Continuous control of insulation towards earth, in IT distribution system at 24...400Vac single-phase network
 Selectable threshold 20...200kΩ or 5...200kΩ
 Alarm relay output

	Input	Alarm threshold	N° output	Aux
RI2A123	24...400Vac	5...200kΩ	1 (alarm)	230Vac
RI2A123	24...400Vac	20...200kΩ	1 (alarm)	230Vac

Cat. Nos. **ISO D4 - direct current**

Insulation relay for IT network in dc, 1 contact, automatic reset, 4 module.
 Continuous control of insulation towards earth, in direct current network at 20...60 - 100...160 - 210...230Vdc
 Selectable threshold 20...200kΩ
 Alarm relay output

	Input	Alarm threshold	N° output	Aux
RI2CC13	20...60Vdc	20...200kΩ	1 (alarm)	230Vac
RI2CA13	100...160Vdc	20...200kΩ	1 (alarm)	230Vac
RI2CE13	210...230Vdc	20...200kΩ	1 (alarm)	230Vac

Technical features

CAT. NOS.	ISO D4 (AC)	ISO D4 (DC)
TECHNICAL NOTES	NT491	NT590
INPUT		
Network voltage	24...400Vac	20...60 - 100...160 - 210...230Vdc
Rated frequency fn	50Hz	-
Working frequency	47...63Hz	-
Metering voltage	12Vdc	-
Metering current	< 50µA	≤ 0,5mA
SETTING UP		
Intervention point	selectable by 6-position rotary switch	
Ranges	20/40/70/100/150/200kΩ or 5/10/20/50/100/200kΩ	20/40/70/100/150/200kΩ
ALARM		
Alarm intervention	red LED "ALARM" + relay switching	
Accuracy	± 10% setting value	
Intervention time	≤ 600ms	
Reset	automatic	
Hysteresis	≤ 20%	
OUTPUT		
Relay "ALARM"	1 SPDT contact	
Contact range	5A 250Vac cosφ 1 – 3A 250Vac cosφ 0,4 – 5A 30Vdc	
AUXILIARY SUPPLY		
Rated value Uaux	150 - 230V	
Tolerance	0,85...1,1Vaux	
Rated frequency	50Hz	
Tolerance	47...63Hz	
Rated burden	≤ 4VA	
MECHANICAL FEATURES		
Housing	4 modules DIN 43880 (35mm)	
Connections	screw terminals for cable up to 4mm ²	
Housing material	self-extinguishing makrolon	
Protection degree (EN/IEC 60529)	IP54 front frame IP20 terminals	

Wiring diagrams

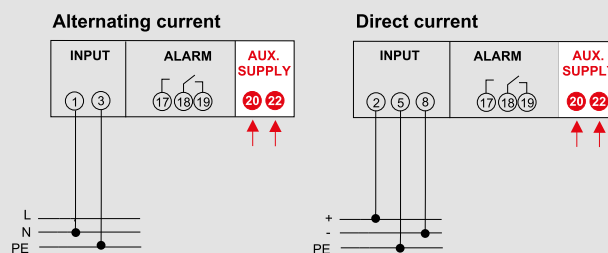

Insulation relays

Alternating current and voltage relay



RM21



RM2U



RM2S

Cat. Nos. **RM21 - Current relay, single-phase network**

Single-phase alternating current relay, 1 contact, selectable min. or max. threshold, automatic or manual reset
Min or max alarm, selectable on field
Adjustable set point, hysteresis and delay
Field selectable negative or positive security (fail safe)
Intervention inhibition when turning on
Ability to store intervention

Input	Alarm threshold	N° output	Aux
RM21M112	1A	1 (min. or max. alarm)	115Vac
RM21M113	1A		230Vac
RM21M11H	1A		20...150Vdc+48Vac
RM21M11L	1A		150...250Vdc
RM21M152	5A		115Vac
RM21M153	5A		230Vac
RM21M15H	5A		20...150Vdc+48Vac
RM21M15L	5A		150...250Vdc

Cat. Nos. **RM2U - Voltage relay, single-phase network**

Single-phase alternating voltage relay, 1 contact, selectable min. or max. threshold, automatic or manual reset.
Min or max alarm, selectable on field
Direct input up to 400V
Adjustable set point, hysteresis and delay
Field selectable negative or positive security (fail safe)
Intervention inhibition when turning on
Ability to store intervention

Input	Alarm threshold	N° output	Aux
RM2UM1A2	100V	1 (min. or max. alarm)	115Vac
RM2UM1A3	100V		230Vac
RM2UM1AH	100V		20...150Vdc+48Vac
RM2UM1AL	100V		150...250Vdc
RM2UM1F2	250V		115Vac
RM2UM1F3	250V		230Vac
RM2UM1FH	250V		20...150Vdc+48Vac
RM2UM1FL	250V		150...250Vdc
RM2UM1K2	400V		115Vac
RM2UM1K3	400V		230Vac
RM2UM1KH	400V		20...150Vdc+48Vac
RM2UM1KL	400V		150...250Vdc

Cat. Nos. **RM2S - Voltage relay, three-phase network**

3-phase alternating voltage relay, 1 contact, sequence/failure/asymmetry phases, automatic reset,
Three phase line 380...415V 50 and 60Hz
Voltage asymmetry threshold adjustable 5...25%
Adjustable intervention time 0,2...10s

Input	Alarm threshold	N° output	Aux
RM3UT3AA	100V	1 (min. or max. alarm)	self supplied
RM3UT3KA	400V		±20%Un

Technical features

CAT. NOS.	RM21	RM2U	RM2S
TECHNICAL NOTES	NT548	NT549	NT639
INPUT			
Rated current In	5A or 1A	-	-
Rated Voltage Un	-	100-250-400V	380...415V
Waveform	sinusoidal, form factor 1,11		
Rated frequency fn	50Hz	50 – 60Hz	
Working frequency	47...63Hz	-	
Rated burden	≤ 0,5VA	≤ 0,2VA	≤ 2,7VA
Continuous overload	1,2In	1,2Un	-
Instantaneous overload	2In/5s	-	-
SETTING UP			
Intervention point	min or max alarm, selectable by dip switch		
Asymmetry intervention threshold	continuously adjustable by trimmer		
Adjustable ranges	10...120%In	10...120%Un	5...25%
Intervention time (t)	0,1...10 seconds		
Repeatability	±1%		-
Intervention inhibit when switching on (ts)	0 - 3 - 6 - 9 seconds		-
Hysteresis adjustable range	5...50% of set point		
Reset	-	-	automatic
OUTPUT			
Relay	1 SPDT contact		
Contact range	5A 250Vac cosφ 1 – 3A 250Vac cosφ 0,4 – 5A 30Vdc		
AUXILIARY SUPPLY			
Rated value Uaux ac	115–230–240V	48-115-230-240V	self supplied
Tolerance	0,9...1,1Uaux	0,9...1,1Uaux - 40...60V (48V)	-
Rated frequency	50Hz	-	
Tolerance	47...63Hz	-	
Rated burden	≤ 2,5VA	-	
Rated value Uaux dc	20...150Vdc – 150...250Vdc	-	
Rated burden	≤ 1W	-	
ELECTROMAGNETIC COMPATIBILITY			
Emission tests according to	EN 50081-1, EN 55011		
Immunity tests according to	EN 50082-2		
ENVIRONMENTAL CONDITIONS			
Nominal temperature range	-5...40°C		
Limit temperature range for storage	-40...70°C		
Max. power dissipation	≤ 2.5W *	≤ 2W *	
MECHANICAL FEATURES			
Housing	2 modules DIN 43880 (35mm)		
Connections	screw terminals for cable up to 4mm ²		
Housing material	self-extinguishing makrolon		
Protection degree	IP40 front frame, IP20 terminals		

* for switchboard thermal calculation

Wiring diagrams

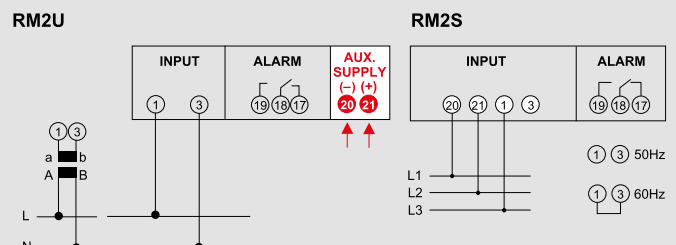
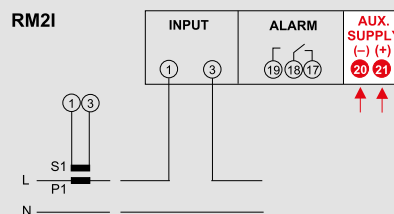

Insulation relays

Alternating current relay



RM3I

Cat. Nos. **RM3I**

3-phase alternating current relay, 2 contacts, 1 min. or max. threshold or 2 max. selectable, automatic or manual reset, DIN rail 100x75x110mm
 Min or max alarm, selectable on field
 Adjustable set point, hysteresis and delay
 Field selectable negative or positive security (fail safe)
 Intervention inhibition when turning on
 Ability to store intervention

RM3IT253	Input	Alarm threshold	N° output	Aux
RM3IT25F	5A	15...100%In	2 (min. or max. alarm or 2 max)	230Vac
	5A			24Vdc

Technical features

TECHNICAL NOTES	NT631
INPUT	
Rated current In	5A
Rated Voltage Un	-
Waveform	sinusoidal, form factor 1,11
Rated frequency fn	50Hz
Working frequency	47...63Hz
Rated burden	≤ 0,5VA
Continuous overload	1,2In
Instantaneous overload	2In/5s
SETTING UP	
Asymmetry intervention threshold	continuously adjustable by trimmer
Adjustable ranges	5...25%
Intervention time (t)	continuously adjustable by trimmer
Reset	automatic
OUTPUT	
Relay	2 SPDT contact
Contact range	5A 250Vac cosφ 1 – 3A 250Vac cosφ 0,4 – 5A 30Vdc
AUXILIARY SUPPLY	
Nominal voltage	230Vac - 24Vdc
ELECTROMAGNETIC COMPATIBILITY	
Emission tests according to	EN 50081-1, EN 55011
Immunity tests according to	EN 50082-2
ENVIRONMENTAL CONDITIONS	
Nominal temperature range	-5...40°C
Limit temperature range for storage	-40...70°C
Suitable for tropical climates	yes
Max. power dissipation	≤ 2W *
MECHANICAL FEATURES	
Mounting	snap-on 35mm DIN rail (5,5 modules)
Connections	screw terminals for cable up to 4mm ²
Housing material	self-extinguishing ABS
Protection degree (EN/IEC 60529)	IP40 front frame, IP20 terminals

* for switchboard thermal calculation

Wiring diagrams

RM3I

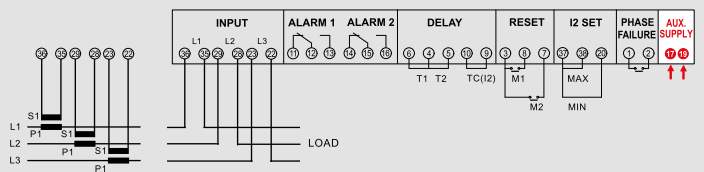

Dimensions

RM3I

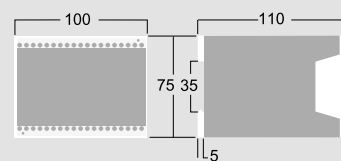

Insulation relays

Alternating voltage relay



RM3U

Cat. Nos. **RM3U**

3-phase alternating voltage relay, 1 contact, 1 min. or max. threshold, automatic reset, DIN rail 70x75x110mm
 Min or max alarm, selectable on field
 Direct input up to 400V
 Adjustable set point, hysteresis and delay
 Field selectable negative or positive security (fail safe)
 Intervention inhibition when turning on
 Ability to store intervention

	Input	Alarm threshold	N° output	Aux
RM3UT3AA	100V	±20%Un	1 (min. or max. alarm)	self supplied
RM3UT3KA	400V			self supplied

Technical features

TECHNICAL NOTES	NT632
INPUT	
Rated current In	5A
Rated Voltage Un	-
Waveform	sinusoidal, form factor 1,11
Rated frequency fn	50Hz
Working frequency	47...63Hz
Rated burden	≤ 0,5VA
Continuous overload	1,2In
Instantaneous overload	2In/5s
SETTING UP	
Asymmetry intervention threshold	continuously adjustable by trimmer
Adjustable ranges	5...25%
Intervention time (t)	continuously adjustable by trimmer
Reset	automatic
OUTPUT	
Relay	2 SPDT contact
Contact range	5A 250Vac cosφ 1 – 3A 250Vac cosφ 0,4 – 5A 30Vdc
AUXILIARY SUPPLY	
Nominal voltage	Taken from measurement (self-supplied)
ELECTROMAGNETIC COMPATIBILITY	
Emission tests according to	EN 50081-1, EN 55011
Immunity tests according to	EN 50082-2
ENVIRONMENTAL CONDITIONS	
Nominal temperature range	-5...40°C
Limit temperature range for storage	-40...70°C
Suitable for tropical climates	yes
Max. power dissipation	≤ 2W *
MECHANICAL FEATURES	
Mounting	snap-on 35mm DIN rail (2,5 modules)
Connections	screw terminals for cable up to 4mm ²
Housing material	self-extinguishing ABS
Protection degree (EN/IEC 60529)	IP40 front frame, IP20 terminals

* for switchboard thermal calculation

Wiring diagrams

RM3U

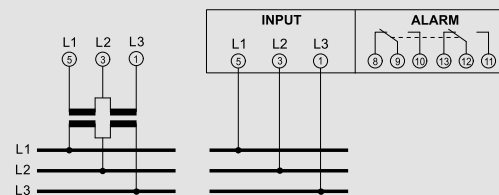

Dimensions

RM3U

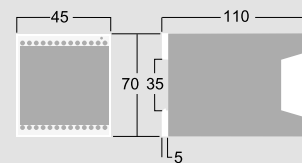

Insulation relays

Direct current and voltage measuring relay



RM3C

Cat. Nos. **RM3C**

Direct current and voltage measuring relay, 2 contacts, min. and/or max. threshold, automatic reset, 2000-points led display for any quantity directly proportional to programmable input, DIN rail 100x75x110mm.
 Bidirectional direct or pulsating voltage or current relay
 2 Min. and / or Max. programmable alarms
 Input voltage 50mV... 200mV
 Input current 1...20mA
 Programmable measuring range
 Programmable display value
 Storage of highest measured value (resettable)

RM3C211
 RM3C213
 RM3C216
 RM3C21H
 RM3C21L

Input	Alarm threshold	N° output	Aux
programmable	programmable	2 (min. or max. alarm)	24Vac
			115Vac
			230Vac
			20...150Vdc+48Vac
			150...250Vdc

Technical features

TECHNICAL NOTES	NT633
DISPLAY	
Type of display	7 segments, red LED's
Digit height	14mm
N° of display points	2.000 (3 1/2 digit)
Maximum display	-1999...1999
Offset	-1999...1999 digit
Full scale	1999...1999 digit
Decimal point	00.00 - 000.0 - 0000
PROGRAMMABLE PARAMETERS	
Range (Un / In)	200mV-20V-200V-20mA-2mA
Measuring range	min. 0...0,25Un/In max. -Un/-In...Un/In
ALARMS	
Programmables alarms	2
Set-point programmable	-1999...1999 digit
Hysteresis programmable	-1999...1999 digit
Intervention time	≤ 500ms
Delay (programmable)	0...60s (1s step)
Delay accuracy	±10%
Reset time	≤ 500ms
Output	2 relays with SPDT contacts, potential free
Contacts range	5A 250Vac - 0,5A 100Vdc
Accuracy	2 (0,25%+K)+ 1 digit
INPUT	
Measurement	direct or pulsating current or voltage, average value
Voltage rating Un	200mV - 20V - 200V
Current rating In	20mA - 2mA
Rated frequency	50Hz
Operating frequency	47...63Hz
Continuous overload	1,2Un - 1,2In
Istantaneous overload	2Un/5s - 2In/5s
AUXILIARY SUPPLY	
Rated value Uaux ac	24-48-115-230-240V
Tolerance	± 10% Uaux - 40...60V(Uaux 48V)
Rated frequency	50Hz
Working frequency	47...63Hz
Rated burden	5VA
Rated value Uaux dc	20...150Vdc - 150...250Vdc
Rated burden	3W
ELECTROMAGNETIC COMPATIBILITY	
Emission tests according to	EN/IEC 61326-1
Immunity tests according to	EN/IEC 61326-1
ENVIRONMENTAL CONDITIONS	
Nominal temperature range	-5...40°C
Limit temperature range for storage	-40...70°C
Max. power dissipation	≤ 3,6W *
MECHANICAL FEATURES	
Mounting	snap-on 35mm DIN rail (5,5 modules)
Connections	screw terminals
Housing material	self-extinguishing makrolon
Protection degree (EN/IEC 60529)	IP52 front frame, IP20 terminals

* for switchboard thermal calculation

Dimensions

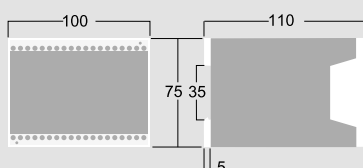

Wiring diagrams

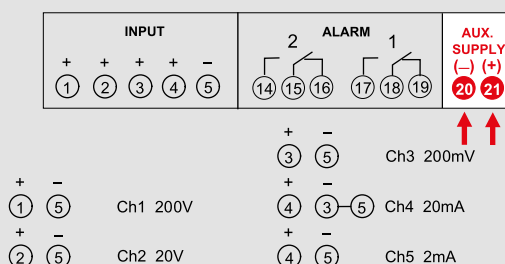

Insulation relays

Power management relay



Beep

Cat. Nos.

Beep

Beep is a consumption management relay for single phase networks with users up to 6 kW, designed to solve this problem. It continuously monitors the power used and, if the power threshold that can be set is exceeded, it emits a warning by means of a buzzer so that the loads can be manually removed in order to reduce the power before the electricity cuts out or, if there is a type output is enabled, it automatically cuts off the non-priority loads. These are then reactivated after a lapse of time that can be programmed. Thanks to the programming of the overload threshold (up to 6.5 kW), it can be used on users with different powers 3-4,5-6 kW (default setting per user 3 kW) and it is able to manage non-priority loads up to 16A. During normal functioning, if the front key is pushed, it is possible to display with red LEDs, the real time values of the active power (kW), the voltage (V) and the current (A).

RM2P133

Input	Alarm threshold	N° output	Aux
230V - 28A	0...6,5kW	1 (SPST 250Vac-16A)	230Vac

Technical features

TECHNICAL NOTES	NT752
DISPLAY	
Type of display	7 segments, red LED's
Digit height	9mm
ALARMS	
Output	1 SPST contact in voltage
Contacts range	250Vac / 16A
Accuracy	± 1%
INPUT	
Measurement	true root-mean-square value
Voltage rating Un	195...264V
Current rating In	28A
Rated frequency	50Hz
Operating frequency	47...63Hz
Rated burden	≤ 0,5W
AUXILIARY SUPPLY	
Rated value Uaux ac	230V
Tolerance	0,85...1,15Uaux
Rated frequency	50Hz
Working frequency	47...63Hz
Rated burden	≤ 3,2VA - 1,8W
ELECTROMAGNETIC COMPATIBILITY	
Emission tests according to	EN 55022 (class B)
ENVIRONMENTAL CONDITIONS	
Nominal temperature range	-5...40°C
Limit temperature range for storage	-40...70°C
Max. power dissipation	2,3W *
MECHANICAL FEATURES	
Housing	2 modules DIN 43880 (35mm)
Connections	screw terminals
Housing material	self-extinguishing polycarbonate
Protection degree (EN/IEC 60529)	IP52 front frame, IP20 terminals

* for switchboard thermal calculation

Wiring diagrams

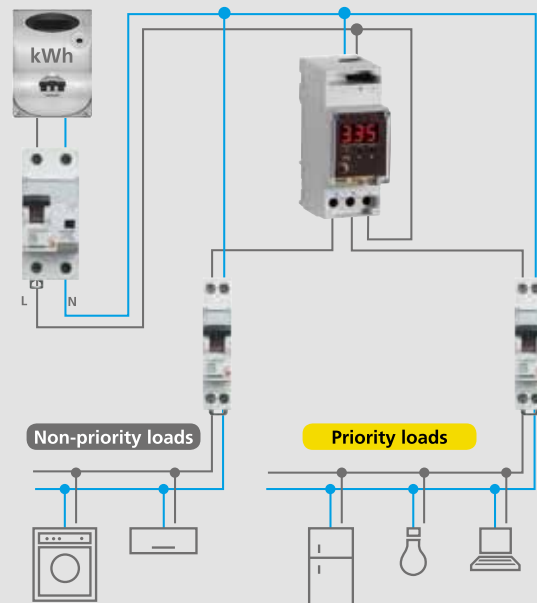
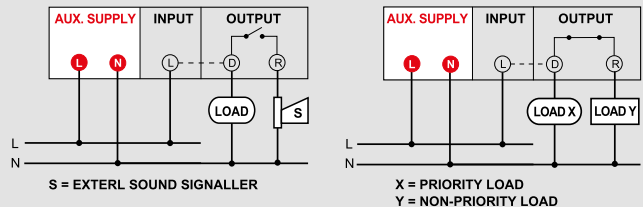

TRANSDUCERS TEMA









Transducers

Selection table

Transducers	TEMA I	TEMA I4	TEMA I4e	TEMA U	TEMA U4	TEMA U4e	
Technical notes	NT546	NT554	NT628	NT547	NT555	NT629	
Network	single phase	single phase	single phase	single phase	single phase	single phase	
Measuring	alternating current	alternating current	alternating current	alternating voltage	alternating voltage	alternating voltage	
Measuring type	according R.M.S.	according R.M.S.	true R.M.S.	according R.M.S.	according R.M.S.	true R.M.S.	
Wave form	sinusoidal form factor 1,11	sinusoidal form factor 1,11	distorted sinusoidal	sinusoidal form factor 1,11	sinusoidal form factor 1,11	distorted sinusoidal	
a.c. auxilliary supply	self-supplied	48 - 115 – 230Va.c.	48 - 115 – 230Va.c.	self-supplied	48 - 115 – 230Va.c.	48 - 115 – 230Va.c.	
d.c. auxilliary supply	-	20...150 – 150...250Vd.c.	20...150 – 150...250Vd.c.	-	20...150 – 150...250Vd.c.	20...150 – 150...250Vd.c.	
Current rated value	0...5 - 0...10 - 0...20mA	0...5/10/20mA - 4...20mA selectable	0...5/10/20mA - 4...20mA selectable	0...5 - 0...10 - 0...20mA	0...5/10/20mA - 4...20mA selectable	0...5/10/20mA - 4...20mA selectable	
Voltage rated value	0...5 - 0...10V	0...5/10V - 2...10V selectable	0...5/10V - 2...10V selectable	0...5 - 0...10V	0...5/10V - 2...10V selectable	0...5/10V - 2...10V selectable	
Response time	≤300ms	≤300ms	≤100ms 50ms (options)	≤300ms	≤300ms	≤100ms 50ms (options)	
Accuracy	0,5 (20...120% In)	0,5	0,5	0,5 (20...120% Un)	0,5	0,5	
Current input	1 - 1,2 - 5 - 6A	1 - 1,2 - 5 - 6A	1 - 1,2 - 5 - 6A	-	-	-	-
Voltage input	-	-	-	100 - 110V 120 - 250V 400 - 440V	100 - 110V 120 - 250V 400 - 440V 500V other value on request of 50...500V	100 - 110V 120 - 250V 400 - 440V 500V other value on request of 50...500V	
Frequency	47...63Hz	47...63Hz	47...63Hz	47...63Hz	47...63Hz	47...63Hz	
Dimensions	2 module DIN	2 module DIN	2 module DIN	2 module DIN	2 module DIN	2 module DIN	

CT with transducers	TT35	TT35A	HT35A	
Technical notes	NT433	NT434	NT500	
Passing cable hole dimensions	35 mm	35 mm	35 mm	
(unidirectional) d.c. rated current	-	-	100-150-200-250-300-400A	
a.c. selectable rated current	5-10-15-20-25-30-35-40-45A 15-30-45-60-75-90-105-120-135A 25-50-75-100-125-150-175-200-225A 50-100-150-200-250-300-350-400-450A	5-10-15-20-25-30-35-40-45A 15-30-45-60-75-90-105-120-135A 25-50-75-100-125-150-175-200-225A 50-100-150-200-250-300-350-400-450A	-	
Output	4...20mA (2 wire technology)	0...20mA - 4...20mA - 0...10V (4 wire technology)	0...20mA - 4...20mA selectable 0...10V	
a.c. auxilliary supply	-	115 – 230Va.c.	48 - 115 – 230 - 240Va.c.	
d.c. auxilliary supply	10...34Vd.c.	-	20...150Vd.c.	
Extra d.c.auxilliary supply	-	-	•	

							
TEMA Pr4	TEMA fP	TEMA SG		TEMA DC			
NT848	NT514	NT229	NT228	NT238		NT239	
single phase - three phase	single phase - three phase	-		-			
programmable	apparent - reactive-active power, power factor, phase angle, average power, frequency	direct current or voltage	direct current signal separator	direct current			
according R.M.S.	true R.M.S.	average value		average value			
	distorted sinusoidal	direct with ≤10% alternating component		direct or pulsating with frequency ≥10Hz			
80...265Va.c.	115 – 230Va.c.	48 - 115 – 230 and 240Va.c.		115 – 230 - 240Va.c.			
110...300Vdc – 11...60Vd.c.	20...150 – 150...250Vd.c.	20...150 – 150...250Vd.c.		20...30 - 40...60 - 90...140 - 180...250Vd.c.			
0...20mA and 4...20mA	0...5/10/20 - 4...20 ± 5/10/20mA selectable	0...5 - 0...20 - 4...20mA		0...20 - 4...20mA	± 20 - 4...20mA	0...20 - 4...20mA	± 20 - 4...20mA
	0...10 ± 10 - 1...5V selectable	0...10V		0...10V	±10V	0...10V	±10V
≤300ms	≤300ms - 100ms (options)	≤150ms	≤150ms	≤300ms			
0,5	0,5 (power) - 1(cos) - ± 0,2Hz (frequency)	0,5		0,5			
5A or 1A	direct or by external CT (with programmable ratios)	4...20mA or other value on request from 1...500mA	0...5 - 0...20 - 4...20mA	4...20mA or other value on request from 400µA...1,5A (unidirectional)	value on request from 250µA...750mA (bidirectional)	-	
	400V (phase-phase) 50...300V (single phase) direct or from VT programmable ratio	0...60mV or other value on request from 50mV...400V	-	-	-	1...5 - 2...10V or other value on request from 10mV...600V (unidirectional)	value on request from 5mV...300V (bidirectional)
47...63Hz	45...65Hz						
96x96mm	8 module DIN	4 module DIN		6 module DIN			

		
HT80A	HT35BM	HT35BS
NT501	NT763	NT763
80 mm	35 mm	35 mm
400-500-600-800-1000A	selectable 10-20-30-40-50-60-70-80-90-100A	selectable 10-20-30-40-50-60-70-80-90-100A
-		
0...20mA - 4...20mA selectable 0...10V		
48 - 115 – 230Va.c.		
20...150Vd.c.		
•		

Transducers

Single phase alternating current transducer



To measure average value, calibration according RMS value
Input on CT/1A - CT/5A

Cat. Nos.	Tema I			
	Input (A)	Output (mA)	Output (V)	Auxiliary supply
TM2IA12	0...1	0...5	-	self-supplied
TM2IA13	0...1	0...10	-	self-supplied
TM2IA14	0...1	0...20	-	self-supplied
TM2IA16	0...1	-	0...5	self-supplied
TM2IA18	0...1	-	0...10	self-supplied
TM2IA22	0...1,2	0...5	-	self-supplied
TM2IA23	0...1,2	0...10	-	self-supplied
TM2IA24	0...1,2	0...20	-	self-supplied
TM2IA26	0...1,2	-	0...5	self-supplied
TM2IA28	0...1,2	-	0...10	self-supplied
TM2IA32	0...5	0...5	-	self-supplied
TM2IA33	0...5	0...10	-	self-supplied
TM2IA34	0...5	0...20	-	self-supplied
TM2IA36	0...5	-	0...5	self-supplied
TM2IA38	0...5	-	0...10	self-supplied
TM2IA42	0...6	0...5	-	self-supplied
TM2IA43	0...6	0...10	-	self-supplied
TM2IA44	0...6	0...20	-	self-supplied
TM2IA46	0...6	-	0...5	self-supplied
TM2IA48	0...6	-	0...10	self-supplied

Technical features

TECHNICAL NOTES	NT546
INPUT	
Current rating I_n	1 - 1,2 - 5 - 6A
Frequency rating	50 Hz (47...63Hz)
Instantaneous overload	20In/1s
Continuous overload	3In
Rated burden	≤2,5VA
OUTPUT	
Type	unidirectional, real or live zero for variable output load
Accuracy (EN 60688)	class 0,5 (20...120% In)
Output load	≤ 500Ω (20mA) ≤ 1kΩ (10mA) ≤ 2kΩ (5mA) ≥ 100kΩ (5V) ≥ 200kΩ (10V)
Response time	≤ 300ms
AUXILIARY SUPPLY	
Nominal voltage	Taken from measurement (self-supplied)
MECHANICAL FEATURES	
Housing	2 module DIN 43880
Housing material	self-extinguishing makrolon
Protection degree	IP20 terminals/ IP50 front frame
Connections type	screw terminals
Connections	for cable up to 4mm ²
ENVIRONMENTAL CONDITIONS	
Nominal temperature range	0...45°C
Storage and transport range	-25...70°C
Suitable for tropical climates	yes
Relative humidity	up to 75%
Max.power dissipation*	≤2W

* for switchboard thermal calculation

Wiring diagrams

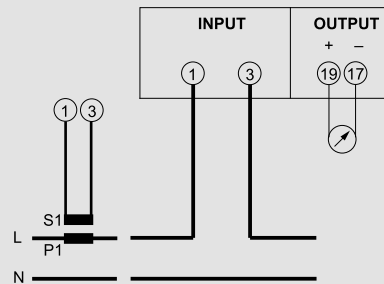

Transducers

Single phase alternating current transducer with selectable output



To measure average value, calibration according RMS value
 Input on CT/1A - CT/5A
 Output selectable on field (7 ranges)
 Selectable values: 0...5/10/20mA - 4...20mA
 0...5/10V - 2...10V

Cat. Nos.	Tema 14		
	Input (A)	Output	Auxiliary supply
TM3I210	0...1	selectable	115Vac
TM3I220	0...1,2	selectable	115Vac
TM3I230	0...5	selectable	115Vac
TM3I240	0...6	selectable	115Vac
TM3I310	0...1	selectable	230Vac
TM3I320	0...1,2	selectable	230Vac
TM3I330	0...5	selectable	230Vac
TM3I340	0...6	selectable	230Vac
TM3IH10	0...1	selectable	20...150Vdc+48Vac
TM3IH20	0...1,2	selectable	20...150Vdc+48Vac
TM3IH30	0...5	selectable	20...150Vdc+48Vac
TM3IH40	0...6	selectable	20...150Vdc+48Vac
TM3IL10	0...1	selectable	150...250Vdc
TM3IL20	0...1,2	selectable	150...250Vdc
TM3IL30	0...5	selectable	150...250Vdc
TM3IL40	0...6	selectable	150...250Vdc

Technical features

TECHNICAL NOTES	NT554
INPUT	
Current rating I_n	1 - 1,2 - 5 - 6A
Frequency rating	50 Hz (47...63Hz)
Instantaneous overload	20In/1s
Continuous overload	3In
Rated burden	≤0,2VA
OUTPUT	
Type	unidirectional, real or live zero for variable output load
Accuracy (EN 60688)	class 0,5
Output load	≤ 750Ω (20mA) ≤ 1,5kΩ (10mA) ≤ 3kΩ (5mA) ≥ 5kΩ (5-10V)
Response time	≤ 300ms
AUXILIARY SUPPLY	
Rated value U_{aux}	48 - 115 - 230Vac 20...150Vdc - 150...250Vdc
Rated burden	≤3VA (Vac) / - ≤1,5W (Vdc)
MECHANICAL FEATURES	
Housing	2 module DIN 43880
Housing material	self-extinguishing makrolon
Protection degree	IP20 terminals/ IP40 front frame
Connections type	screw terminals
Connections	for cable up to 4mm ²
ENVIRONMENTAL CONDITIONS	
Nominal temperature range	0...45°C
Storage and transport range	-25...70°C
Suitable for tropical climates	yes
Relative humidity	up to 75%
Max.power dissipation*	≤2,6W

* for switchboard thermal calculation

Wiring diagrams

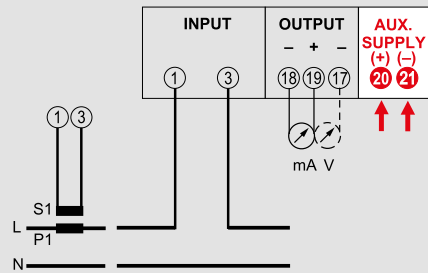

Transducers

TRMS Single phase alternating current transducer with selectable output



To measure TRUE RMS value
 Input by CT/1A - CT/5A
 Output selectable on field (7 ranges)
 Selectable values: 0...5/10/20mA - 4...20mA
 0...5/10V - 2...10V

Cat. Nos.	Tema I4e		
	Input (A)	Output	Auxiliary supply
TM4I210	0...1	selectable	115Vac
TM4I220	0...1,2	selectable	115Vac
TM4I230	0...5	selectable	115Vac
TM4I240	0...6	selectable	115Vac
TM4I310	0...1	selectable	230Vac
TM4I320	0...1,2	selectable	230Vac
TM4I330	0...5	selectable	230Vac
TM4I340	0...6	selectable	230Vac
TM4IH10	0...1	selectable	20...150Vdc+48Vac
TM4IH20	0...1,2	selectable	20...150Vdc+48Vac
TM4IH30	0...5	selectable	20...150Vdc+48Vac
TM4IH40	0...6	selectable	20...150Vdc+48Vac
TM4IL10	0...1	selectable	150...250Vdc
TM4IL20	0...1,2	selectable	150...250Vdc
TM4IL30	0...5	selectable	150...250Vdc
TM4IL40	0...6	selectable	150...250Vdc

NOTE: Executions available on all models, response time 50msec, add 2 at the end of product code.

Technical features

TECHNICAL NOTES	NT628
INPUT	
Current rating I_n Other value on request	1 - 1,2 - 5 - 6A
Frequency rating	50 Hz (47...63Hz)
Instantaneous overload	20In/1s
Continuous overload	3In
Rated burden	≤2VA
OUTPUT	
Type	unidirectional, real or live zero for variable output load
Accuracy (EN 60688)	class 0,5
Output load	≤ 750Ω (20mA) ≤ 1,5kΩ (10mA) ≤ 3kΩ (5mA) ≥ 5kΩ (5-10V)
Response time	≤ 100ms
AUXILIARY SUPPLY	
Rated value U_{aux}	48 - 115 - 230Vac 20...150Vdc - 150...250Vdc
Rated burden	≤3VA (Vac) - ≤1,5W (Vdc)
MECHANICAL FEATURES	
Housing	2 module DIN 43880
Housing material	self-extinguishing makrolon
Protection degree	IP20 terminals/ IP40 front frame
Connections type	screw terminals
Connections	for cable up to 4mm ²
ENVIRONMENTAL CONDITIONS	
Nominal temperature range	0...45°C
Storage and transport range	-25...70°C
Suitable for tropical climates	yes
Relative humidity	up to 75%
Max.power dissipation*	≤2,6W

* for switchboard thermal calculation

Wiring diagrams

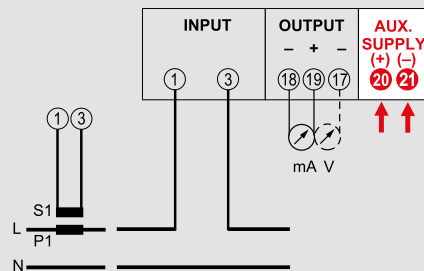

Transducers

Single phase alternating voltage transducer



To measure average value, calibration according RMS value
Direct input up to 440V or by VT

Cat. Nos.	Tema U			
	Input (V)	Output (mA)	Output (V)	Auxiliary supply
TM2UA12	0...100	0...5	-	self-supplied
TM2UA13	0...100	0...10	-	self-supplied
TM2UA14	0...100	0...20	-	self-supplied
TM2UA16	0...100	-	0...5	self-supplied
TM2UA18	0...100	-	0...10	self-supplied
TM2UA22	0...110	0...5	-	self-supplied
TM2UA23	0...110	0...10	-	self-supplied
TM2UA24	0...110	0...20	-	self-supplied
TM2UA26	0...110	-	0...5	self-supplied
TM2UA28	0...110	-	0...10	self-supplied
TM2UA32	0...120	0...5	-	self-supplied
TM2UA33	0...120	0...10	-	self-supplied
TM2UA34	0...120	0...20	-	self-supplied
TM2UA36	0...120	-	0...5	self-supplied
TM2UA38	0...120	-	0...10	self-supplied
TM2UA72	0...250	0...5	-	self-supplied
TM2UA73	0...250	0...10	-	self-supplied
TM2UA74	0...250	0...20	-	self-supplied
TM2UA76	0...250	-	0...5	self-supplied
TM2UA78	0...250	-	0...10	self-supplied
TM2UA92	0...400	0...5	-	self-supplied
TM2UA93	0...400	0...10	-	self-supplied
TM2UA94	0...400	0...20	-	self-supplied
TM2UA96	0...400	-	0...5	self-supplied
TM2UA98	0...400	-	0...10	self-supplied
TM2UAA2	0...440	0...5	-	self-supplied
TM2UAA3	0...440	0...10	-	self-supplied
TM2UAA4	0...440	0...20	-	self-supplied
TM2UAA6	0...440	-	0...5	self-supplied
TM2UAA8	0...440	-	0...10	self-supplied

Technical features

TECHNICAL NOTES	NT547
INPUT	
Voltage rating U_n	100 - 110 - 120 - 250 - 400 - 440V
Frequency rating	50 Hz (47...63Hz)
Instantaneous overload	$2U_n/1s$ (max 450V)
Rated burden	$\leq 2,5VA$
OUTPUT	
Type	unidirectional, real zero for variable output load
Accuracy (EN 60688)	class 0,5 (20...120% U_n)
Output load	$\leq 500 \Omega$ (20 mA) $\leq 1 k\Omega$ (10mA) $\leq 2 k\Omega$ (5mA) $\geq 100k\Omega$ (5V) $\geq 200k\Omega$ (1V)
Response time	$\leq 300ms$
AUXILIARY SUPPLY	
Nominal voltage	Taken from measurement (self-supplied)
MECHANICAL FEATURES	
Housing	2 module DIN 43880
Housing material	self-extinguishing makrolon
Protection degree	IP20 terminals/ IP50 front frame
Connections type	screw terminals
Connections	for cable up to 4mm ²
ENVIRONMENTAL CONDITIONS	
Nominal temperature range	0...45°C
Storage and transport range	-25...70°C
Suitable for tropical climates	yes
Relative humidity	up to 75%
Max.power dissipation*	$\leq 2W$

* for switchboard thermal calculation

Wiring diagrams

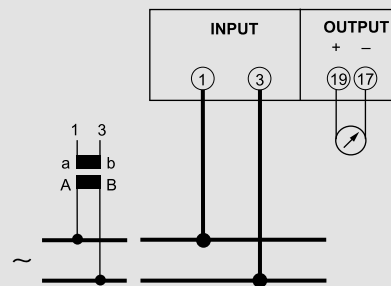

Transducers

Single phase alternating voltage transducer with selectable output



To measure average value, calibration according RMS value
 Direct input up to 500V or by VT
 Output selectable on field (7 ranges)
 Selectable values: 0...5/10/20mA - 4...20mA
 0...5/10V - 2...10V

Cat. Nos.	Tema U4		
	Input (V)	Output	Auxiliary supply
TM3U210	0...100	selectable	115Vac
TM3U220	0...110	selectable	115Vac
TM3U230	0...120	selectable	115Vac
TM3U270	0...250	selectable	115Vac
TM3U290	0...400	selectable	115Vac
TM3U2A0	0...440	selectable	115Vac
TM3U2C0	0...500	selectable	115Vac
TM3U2P0	0...50<>500V *	selectable	115Vac
TM3U310	0...100	selectable	230Vac
TM3U320	0...110	selectable	230Vac
TM3U330	0...120	selectable	230Vac
TM3U370	0...250	selectable	230Vac
TM3U390	0...400	selectable	230Vac
TM3U3A0	0...440	selectable	230Vac
TM3U3C0	0...500	selectable	230Vac
TM3U3P0	0...50<>500V *	selectable	230Vac
TM3UH10	0...100	selectable	20...150Vdc+48Vac
TM3UH20	0...110	selectable	20...150Vdc+48Vac
TM3UH30	0...120	selectable	20...150Vdc+48Vac
TM3UH70	0...250	selectable	20...150Vdc+48Vac
TM3UH90	0...400	selectable	20...150Vdc+48Vac
TM3UHA0	0...440	selectable	20...150Vdc+48Vac
TM3UHC0	0...500	selectable	20...150Vdc+48Vac
TM3UHP0	0...50<>500V *	selectable	20...150Vdc+48Vac
TM3UL10	0...100	selectable	150...250Vdc
TM3UL20	0...110	selectable	150...250Vdc
TM3UL30	0...120	selectable	150...250Vdc
TM3UL70	0...250	selectable	150...250Vdc
TM3UL90	0...400	selectable	150...250Vdc
TM3ULA0	0...440	selectable	150...250Vdc
TM3ULC0	0...500	selectable	150...250Vdc
TM3ULP0	0...50<>500V *	selectable	150...250Vdc

* In addition to the product code pls. indicate the input value corresponding to output

Technical features

TECHNICAL NOTES	NT555
INPUT	
Voltage rating Un Other value on request	100 - 110 - 120 - 250 - 400 - 500V
Frequency rating	50 Hz (47...63Hz)
Instantaneous overload	2Un/1s (max 600V)
Rated burden	≤0,5VA
OUTPUT	
Type	unidirectional, real or live zero for variable output load
Accuracy (EN 60688)	class 0,5
Rated value	selectable by dip switch (7 ranges)
Output load	≤ 750Ω (20mA) ≤ 1,5kΩ (10mA) ≤ 3kΩ (5mA) ≥ 5kΩ (5-10V)
Response time	≤ 300ms
AUXILIARY SUPPLY	
Rated value Uaux	48 - 115 - 230Vac 20...150Vdc - 150...250Vdc
Rated burden	≤3VA (Vac) ≤1,5W (Vdc)
MECHANICAL FEATURES	
Housing	2 module DIN 43880
Housing material	self-extinguishing makrolon
Protection degree	IP20 terminals/ IP40 front frame
Connections type	screw terminals
Connections	for cable up to 4mm ²
ENVIRONMENTAL CONDITIONS	
Nominal temperature range	0...45°C
Storage and transport range	-25...70°C
Suitable for tropical climates	yes
Relative humidity	up to 75%
Max.power dissipation*	≤2,6W

* for switchboard thermal calculation

Wiring diagrams

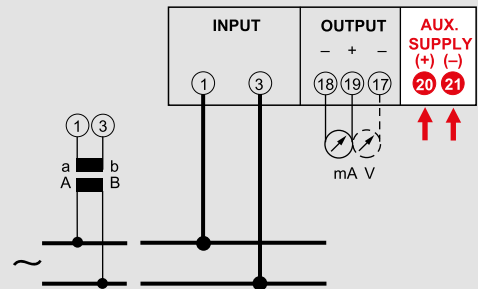

Transducers

TRMS Single phase alternating voltage transducer with selectable output



To measure TRUE RMS value
 Direct input up to 500V or by VT
 Output selectable on field (7 ranges)
 Selectable values: 0...5/10/20mA - 4...20mA
 0...5/10V - 2...10V

Cat. Nos.	Tema U4e		
	Input (V)	Output	Auxiliary supply
TM4U210	0...100	selectable	115Vac
TM4U220	0...110	selectable	115Vac
TM4U230	0...120	selectable	115Vac
TM4U270	0...250	selectable	115Vac
TM4U290	0...400	selectable	115Vac
TM4U2A0	0...440	selectable	115Vac
TM4U2C0	0...500	selectable	115Vac
TM4U2P0	0...50<>500V *	selectable	115Vac
TM4U310	0...100	selectable	230Vac
TM4U320	0...110	selectable	230Vac
TM4U330	0...120	selectable	230Vac
TM4U370	0...250	selectable	230Vac
TM4U390	0...400	selectable	230Vac
TM4U3A0	0...440	selectable	230Vac
TM4U3C0	0...500	selectable	230Vac
TM4U3P0	0...50<>500V *	selectable	230Vac
TM4UH10	0...100	selectable	20...150Vdc+48Vac
TM4UH20	0...110	selectable	20...150Vdc+48Vac
TM4UH30	0...120	selectable	20...150Vdc+48Vac
TM4UH70	0...250	selectable	20...150Vdc+48Vac
TM4UH90	0...400	selectable	20...150Vdc+48Vac
TM4UHA0	0...440	selectable	20...150Vdc+48Vac
TM4UHC0	0...500	selectable	20...150Vdc+48Vac
TM4UHP0	0...50<>500V *	selectable	20...150Vdc+48Vac
TM4UL10	0...100	selectable	150...250Vdc
TM4UL20	0...110	selectable	150...250Vdc
TM4UL30	0...120	selectable	150...250Vdc
TM4UL70	0...250	selectable	150...250Vdc
TM4UL90	0...400	selectable	150...250Vdc
TM4ULA0	0...440	selectable	150...250Vdc
TM4ULC0	0...500	selectable	150...250Vdc
TM4ULP0	0...50<>500V *	selectable	150...250Vdc

* In addition to the product code pls. indicate the input value corresponding to output
 NOTE: Executions available on all models, response time 50msec, add 2 at the end of product code.

Technical features

TECHNICAL NOTES	NT629
INPUT	
Current rating I_n	1 - 1,2 - 5 - 6A
Frequency rating	50 Hz (47...63Hz)
Instantaneous overload	$2U_n/1s$ (max 600V)
Continuous overload	$3I_n$
Rated burden	$\leq 0,5VA$
OUTPUT	
Type	unidirectional, real or live zero for variable output load
Accuracy (EN 60688)	class 0,5
Output load	$\leq 750\Omega$ (20mA) $\leq 1,5k\Omega$ (10mA) $\leq 3k\Omega$ (5mA) $\geq 5k\Omega$ (5-10V)
Response time	$\leq 100ms$
AUXILIARY SUPPLY	
Rated value U_{aux}	48 - 115 - 230Vac
Rated burden	20...150Vdc - 150...250Vdc $\leq 3VA$ (Vac) $\leq 1,5W$ (Vdc)
MECHANICAL FEATURES	
Housing	2 module DIN 43880
Housing material	self-extinguishing makrolon
Protection degree	IP20 terminals/ IP40 front frame
Connections type	screw terminals
Connections	for cable up to 4mm ²
ENVIRONMENTAL CONDITIONS	
Nominal temperature range	0...45°C
Storage and transport range	-25...70°C
Suitable for tropical climates	yes
Relative humidity	up to 75%
Max.power dissipation*	$\leq 2,6W$

* for switchboard thermal calculation

Wiring diagrams

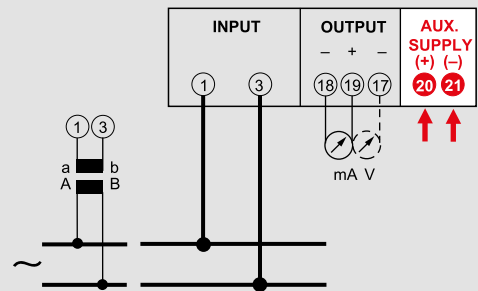

Transducers

Programmable transducer



Keyboard programmable transducer single-phase and three-phase
 Wholly field programmable
 Direct three-phase voltage input up to 500V or by V.T, current input by CT 1/5A
 True R.M.S. measurements
 Output programmable 10 ranges, 0...5/10/20 - 4...20mA ± 5/10/20mA, 0...10V
 - 1...5V ± 10V
 Measured quantity:
 Active/reactive/apparent power
 Power factor
 Phase angle
 Power demand
 Frequency

Cat. Nos.	Tema fP			
	Input (A)	Input (V)	Output	Auxiliary supply
TM8P02110	1	80...500	selectable	115Vac
TM8P02120	5	80...500	selectable	115Vac
TM8P03110	1	80...500	selectable	230Vac
TM8P03120	5	80...500	selectable	230Vac
TM8POH110	1	80...500	selectable	20...150Vdc
TM8POH120	5	80...500	selectable	20...150Vdc
TM8POL110	1	80...500	selectable	150...250Vdc
TM8POL120	5	80...500	selectable	150...250Vdc

NOTE: Executions available on all models, response time 100msec, add 2 at the end of product code.

Technical features

TECHNICAL NOTES	NT514
INPUT	
Voltage rating U_n	400V (phase-phase) (80...500V)
Frequency f_n	50Hz (45...65Hz)
Current rating I_n	5A or 1A
Instantaneous overload	$2U_n/1s - 20I_n/1s$
Rated burden	$\leq 0,5VA$ (each phase)
OUTPUT	
Type	unidirectional and reversible, real or live zero for variable output load
Accuracy (EN 60688)	cl.0,5 (power) - cl.1 (power factor) - $\pm 0,2Hz$ (frequency)
Rated value	programmable (10 ranges)
Output load	$\leq 750\Omega$ (20mA) $\leq 1,5k\Omega$ (10mA) $\leq 3k\Omega$ (5mA) $\geq 5k\Omega$ (5-10V)
Response time	$\leq 300ms - 100ms$ (options)
AUXILIARY SUPPLY	
Rated value U_{aux}	115 - 230Vac 20...150Vdc - 150...250Vdc
Rated burden	$\leq 3VA$ (Vac) $\leq 3W$ (Vdc)
MECHANICAL FEATURES	
Dimensions	8 module DIN 43880 (35mm)
Housing material	self-extinguishing polycarbonate
Protection degree	IP20 terminals/ IP52 front frame
Connections type	screw terminals
Rigid cable	max 6mm ²
Flexible cable	max 4mm ²
ENVIRONMENTAL CONDITIONS	
Nominal temperature range	0...50°C
Storage and transport range	-25...70°C
Suitable for tropical climates	yes
Max.power dissipation*	$\leq 4,8W$

* for switchboard thermal calculation

Wiring diagrams

Single phase network

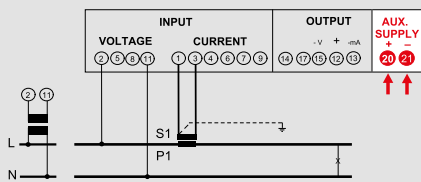

Three-phase 3Ph network, balanced load

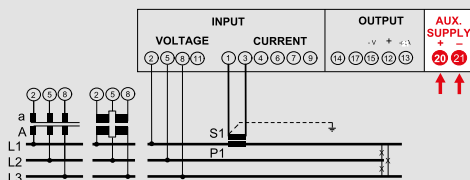

Three-phase 3Ph + N network, balanced load

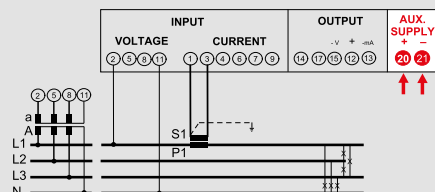

Wiring diagrams

Three-phase 3Ph + N network, unbalanced load

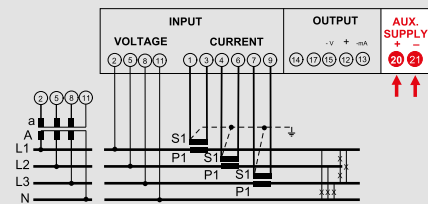

Three-phase 3Ph network, unbalanced load

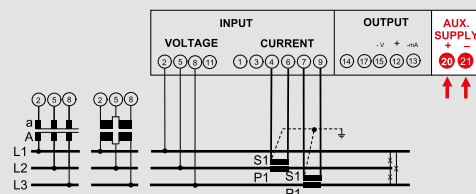

Three-phase 3Ph network, unbalanced load

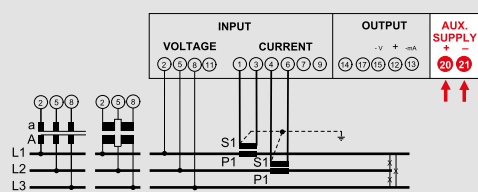

Transducers

Programmable transducer through RS232 communication



Single and three-phase 3-4 wire network
 Direct three phase voltage input up to 690V or by VT, current input by CT 1/5A
 4 analog outputs 0...20mA or 4...20mA
 Quantities which can be associated to the output:
 Phase or linked voltage
 Phase current
 Phase or three-phase active/reactive power
 Power factor
 Frequency
 Average active/reactive power and current

Cat. Nos.	Tema Pr4			
	Input (V)	Input (A)	Output	Auxiliary supply
TM960411	80...690	1	selectable	80...265Vac 110...300Vdc
TM960412	80...690	1	selectable	11...60Vdc
TM960451	80...690	5	selectable	80...265Vac 110...300Vdc
TM960452	80...690	5	selectable	11...60Vdc

Cat. Nos.	Accessories	
	Description	
ATM96002	Programming kit (software + RS232 module + USB adapter)	
IF96005	Alarm module 2 relay outputs associable to 2 quantities measured by Tema Pr4	

Technical features

TECHNICAL NOTES	NT848
INPUT	
Voltage rating U_n	400V (phase-phase) (80...690V)
Frequency f_n	50Hz (45...65Hz)
Instantaneous overload	20 In/0,5s
Continuous overload	1,2In
Rated burden	$\leq 0,5VA$ (each phase)
OUTPUT	
Type	unidirectional at real or shifted zero, for variable output load
Accuracy (EN 60688)	class 0,5
Rated value	4 for 0...20mA 4...20mA
Output load	$\leq 750\Omega$
Response time	$\leq 300ms$
AUXILIARY SUPPLY	
On the analog output module the transducer has 2 red LED's which show the presence of the auxiliary supply	
Rated value U_{aux}	80...265Vac 110...300Vdc - 11...60Vdc
Rated burden	$\leq 7VA$ (Vac) $\leq 5W$ (Vdc)
MECHANICAL FEATURES	
Housing	flush mounting (panel cutout 92x92mm)
Front frame	96x96mm
Depth	101,3mm
Housing material	self-extinguishing polycarbonate
Protection degree	IP20 terminals/ IP40 front frame
Connections type	screw terminals
Rigid cable	max 4,5mm ² (volt.) max 6mm ² (amp.)
Flexible cable	max 2,5mm ² (volt.) max 4mm ² (amp.)
ENVIRONMENTAL CONDITIONS	
Nominal temperature range	-5...55°C
Storage and transport range	-25...70°C
Suitable for tropical climates	yes
Max.power dissipation*	$\leq 6W$

* for switchboard thermal calculation

Wiring diagrams

Single phase network

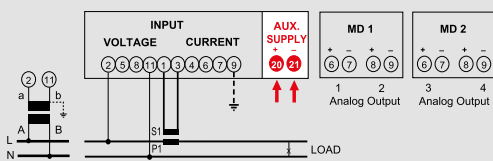

Three-phase 3Ph network, balanced load

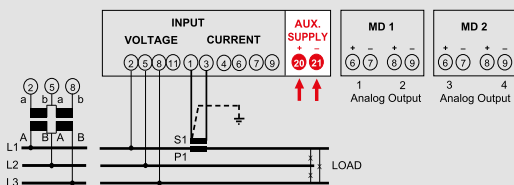

Three-phase 3Ph + N network, balanced load

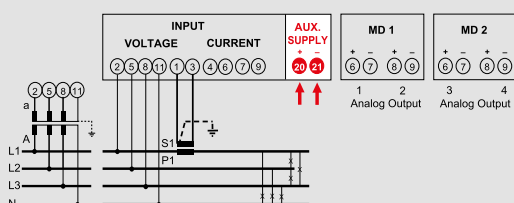

Wiring diagrams

Three-phase 3Ph network, unbalanced load

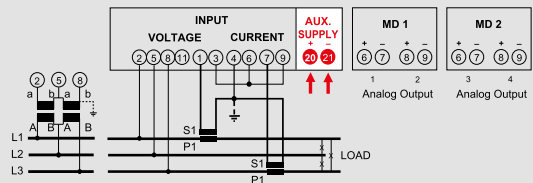

Three-phase 3Ph network, unbalanced load

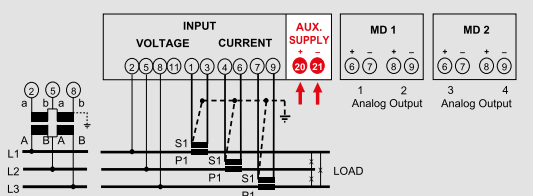

Transducers

Unidirectional direct current transducer



Standard signal galvanic insulation
 Universal input 0...5/20mA - 4...20mA
 Output 0...5/20mA - 4...20mA or 0...10V

Cat. Nos. **Tema SG**

Cat. Nos.	Input (mA)	Output	Auxiliary supply
TM3G112	0...5	0...5mA	115+230Vac
TM3G114	0...5	0...20mA	115+230Vac
TM3G115	0...5	4...20mA	115+230Vac
TM3G118	0...5	0...10V	115+230Vac
TM3G132	0...20	0...5mA	115+230Vac
TM3G134	0...20	0...20mA	115+230Vac
TM3G135	0...20	4...20mA	115+230Vac
TM3G138	0...20	0...10V	115+230Vac
TM3G142	4...20	0...5mA	115+230Vac
TM3G144	4...20	0...20mA	115+230Vac
TM3G145	4...20	4...20mA	115+230Vac
TM3G148	4...20	0...10V	115+230Vac
TM3GH12	0...5	0...5mA	20...150Vdc+48Vac
TM3GH14	0...5	0...20mA	20...150Vdc+48Vac
TM3GH15	0...5	4...20mA	20...150Vdc+48Vac
TM3GH18	0...5	0...10V	20...150Vdc+48Vac
TM3GH32	0...20	0...5mA	20...150Vdc+48Vac
TM3GH34	0...20	0...20mA	20...150Vdc+48Vac
TM3GH35	0...20	4...20mA	20...150Vdc+48Vac
TM3GH38	0...20	0...10V	20...150Vdc+48Vac
TM3GH42	4...20	0...5mA	20...150Vdc+48Vac
TM3GH44	4...20	0...20mA	20...150Vdc+48Vac
TM3GH45	4...20	4...20mA	20...150Vdc+48Vac
TM3GH48	4...20	0...10V	20...150Vdc+48Vac
TM3GL12	0...5	0...5mA	150...250Vdc
TM3GL14	0...5	0...20mA	150...250Vdc
TM3GL15	0...5	4...20mA	150...250Vdc
TM3GL18	0...5	0...10V	150...250Vdc
TM3GL32	0...20	0...5mA	150...250Vdc
TM3GL34	0...20	0...20mA	150...250Vdc
TM3GL35	0...20	4...20mA	150...250Vdc
TM3GL38	0...20	0...10V	150...250Vdc
TM3GL42	4...20	0...5mA	150...250Vdc
TM3GL44	4...20	0...20mA	150...250Vdc
TM3GL45	4...20	4...20mA	150...250Vdc
TM3GL48	4...20	0...10V	150...250Vdc

Technical features

TECHNICAL NOTES	NT228
INPUT	
Type	unidirectional
Current rating I _n	5 - 20mA 4...20mA
Continuous overload	50mA
Voltage drop	≤5V
OUTPUT	
Type	unidirectional real or live zero for variable output load
Accuracy (EN 60688)	class 0,5
Rated values	0...5mA - 0...20mA - 4...20mA - 0...40V
Output load	≤ 750Ω (20mA) ≤ 1,5kΩ (10mA) ≤ 3kΩ (5mA) ≥ 5kΩ (10V)
Response time	≤150ms
AUXILIARY SUPPLY	
Nominal voltage	48 - 115 - 230Vca
Rated burden	≤4VA (Vac) ≤3W (Vdc)
MECHANICAL FEATURES	
Dimensions	4 module DIN 43880 (35mm)
Housing material	self-extinguishing polycarbonate
Protection degree	IP20 terminals/ IP51 front frame
Connections type	screw terminals
Connections	for cable up to 4mm ²
ENVIRONMENTAL CONDITIONS	
Nominal temperature range	-0...45°C
Storage and transport range	-25...70°C
Suitable for tropical climates	yes

Transducers

Unidirectional direct current or voltage transducers



To measure direct current 1...500mA
 Standard signal galvanic insulation: 0...5/10/20mA - 4...20mA
 Input voltage drop ≤100mV

To measure direct voltage 50mV...400V
 Standard signal galvanic insulation: 0...5/10V - 1...5V
 Connection by shunts 60-100-150mV

Cat. Nos.	Tema SG		
	Input	Output (mA)	Auxiliary supply
TM2G142	4...20mA	0...5	115+230Vac
TM2G144	4...20mA	0...20	115+230Vac
TM2G145	4...20mA	4...20	115+230Vac
TM2G152	0...60mV	0...5	115+230Vac
TM2G154	0...60mV	0...20	115+230Vac
TM2G155	0...60mV	4...20	115+230Vac
TM2G1P2	0...1<->500mA 0...50mV<->400V *	0...5	115+230Vac
TM2G1P4	0...1<->500mA 0...50mV<->400V *	0...20	115+230Vac
TM2G1P5	0...1<->500mA 0...50mV<->400V *	4...20	115+230Vac
TM2GH42	4...20mA	0...5	20...150Vdc+48Vac
TM2GH44	4...20mA	0...20	20...150Vdc+48Vac
TM2GH45	4...20mA	4...20	20...150Vdc+48Vac
TM2GH52	0...60mV	0...5	20...150Vdc+48Vac
TM2GH54	0...60mV	0...20	20...150Vdc+48Vac
TM2GH55	0...60mV	4...20	20...150Vdc+48Vac
TM2GHP2	0...1<->500mA 0...50mV<->400V *	0...5	20...150Vdc+48Vac
TM2GHP4	0...1<->500mA 0...50mV<->400V *	0...20	20...150Vdc+48Vac
TM2GHP5	0...1<->500mA 0...50mV<->400V *	4...20	20...150Vdc+48Vac
TM2GL42	4...20mA	0...5	150...250Vdc
TM2GL44	4...20mA	0...20	150...250Vdc
TM2GL45	4...20mA	4...20	150...250Vdc
TM2GL52	0...60mV	0...5	150...250Vdc
TM2GL54	0...60mV	0...20	150...250Vdc
TM2GL55	0...60mV	4...20	150...250Vdc
TM2GLP2	0...1<->500mA 0...50mV<->400V *	0...5	150...250Vdc
TM2GLP4	0...1<->500mA 0...50mV<->400V *	0...20	150...250Vdc
TM2GLP5	0...1<->500mA 0...50mV<->400V *	4...20	150...250Vdc

* In addition to the product code pls. indicate the input value corresponding to output

Technical features

TECHNICAL NOTES	NT229
INPUT	
Type	unidirectional
Voltage rating Un	60mV - 50mV...400V
Current rating In	1...500mA
Voltage drop	≤100mV
Rared burden	≤ 0,2mA
OUTPUT	
Type	unidirectional real or live zero for variable output load
Accuracy (EN 60688)	class 0,5
Rated values	0...5mA - 0...20mA - 4...20mA
Output load	≤ 250Ω (20mA) - ≤ 1kΩ (5mA)
Response time	≤ 150ms
AUXILIARY SUPPLY	
Rated value Uaux	48 - 115 - 230Vac
Other value on request	20...150Vdc - 150...250Vdc
Rated burden	≤4VA (Vac) ≤3W (Vdc)
MECHANICAL FEATURES	
Dimensions	4 module DIN 43880 (35mm)
Housing material	self-extinguishing polycarbonate
Protection degree	IP20 terminals/ IP51 front frame
Connections type	screw terminals
Connections	for cable up to 4mm ²
ENVIRONMENTAL CONDITIONS	
Nominal temperature range	-0...45°C
Storage and transport range	-25...70°C
Suitable for tropical climates	yes

Transducers

Unidirectional or bidirectional direct current transducers



To measure direct or pulsating current (average value)
 Input unidirectional from 0...500µA to 0...1,5A
 Input bidirectional from ± 250µA to ± 750mA

Cat. Nos.	Tema DC		
	Input	Output	Auxiliary supply
TM1A114	0...400<>800µA *	0...20mA	115+230Vac
TM1A115	0...400<>800µA *	4...20mA	115+230Vac
TM1A118	0...400<>800µA *	0...10V	115+230Vac
TM1A124	0...1<>800mA *	0...20mA	115+230Vac
TM1A125	0...1<>800mA *	4...20mA	115+230Vac
TM1A128	0...1<>800mA *	0...10V	115+230Vac
TM1A134	0...1<>1,5A *	0...20mA	115+230Vac
TM1A135	0...1<>1,5A *	4...20mA	115+230Vac
TM1A138	0...1<>1,5A *	0...10V	115+230Vac
TM1A144	4...20mA	0...20mA	115+230Vac
TM1A145	4...20mA	4...20mA	115+230Vac
TM1A148	4...20mA	0...10V	115+230Vac
TM1A155	±250<>±800µA *	4...20mA	115+230Vac
TM1A15E	±250<>±800µA *	±20mA	115+230Vac
TM1A15H	±250<>±800µA *	±10V	115+230Vac
TM1A165	±1<>±750mA *	4...20mA	115+230Vac
TM1A16E	±1<>±750mA *	±20mA	115+230Vac
TM1A16H	±1<>±750mA *	±10V	115+230Vac

* In addition to the product code pls. indicate the input value corresponding to output

Auxiliary supply	Others auxiliary supply value on request
20...30VDC	Replace the 5th number (1) of the product code with C
40...60VDC	Replace the 5th number (1) of the product code with D
90...140VDC	Replace the 5th number (1) of the product code with E
180...250VDC	Replace the 5th number (1) of the product code with F

Technical features

TECHNICAL NOTES	NT239
INPUT	
Unidirectional current rating	500µA...1,5A
Bidirectional current rating	250µA...750mA
Excessive input of short duration	20In/1s (max. 5A)
Voltage drop	≤ 1V with input ≤ 500mA ≤ 0,5V with input > 500mA
OUTPUT	
Type	unidirectional or bidirectional, real or live zero for variable output load
Accuracy (EN 60688)	class 0,5
Current rated values	0...20 - 4...20mA
Output load	≤ 750Ω (20mA) ≤ 1,5kΩ (10mA) ≤ 3kΩ (5mA) ≥ 5kΩ (10V)
Voltage rated values	0...10V
Output load	> 5kΩ
Response time	≤ 300ms
AUXILIARY SUPPLY	
Rated value Uaux ac Other value on request	115 and 230V
Rated burden	≤5VA (Vac) ≤4W (Vdc)
MECHANICAL FEATURES	
Dimensions	6 module DIN 43880 (35mm)
Housing material	self-extinguishing polycarbonate
Protection degree	IP20 terminals/ IP51 front frame
Connections type	screw terminals
Connections	for cable up to 4mm ²
ENVIRONMENTAL CONDITIONS	
Nominal temperature range	-0...45°C
Storage and transport range	-25...70°C
Suitable for tropical climates	yes
Max.power dissipation*	≤4,5W

* for switchboard thermal calculation

Wiring diagrams

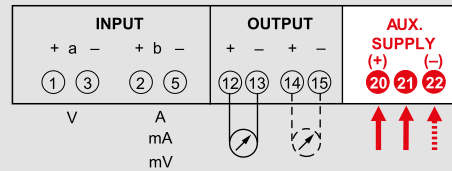

Transducers

Unidirectional or bidirectional direct voltage transducers



To measure direct or pulsating voltage (average value)
 Input unidirectional from 10mV to 600V
 Input bidirectional from ± 5mV to ± 300mV

Cat. Nos.	Tema DC		
	Input	Output	Auxiliary supply
TM1V114	0...10<>600mV *	0...20mA	115+230Vac
TM1V115	0...10<>600mV *	4...20mA	115+230Vac
TM1V118	0...10<>600mV *	0...10V	115+230Vac
TM1V124	0...1<>600V *	0...20mA	115+230Vac
TM1V125	0...1<>600V *	4...20mA	115+230Vac
TM1V128	0...1<>600V *	0...10V	115+230Vac
TM1V134	1...5V	0...20mA	115+230Vac
TM1V135	1...5V	4...20mA	115+230Vac
TM1V138	1...5V	0...10V	115+230Vac
TM1V144	2...10V	0...20mA	115+230Vac
TM1V145	2...10V	4...20mA	115+230Vac
TM1V148	2...10V	0...10V	115+230Vac
TM1V155	±5<>±600mV *	4...20mA	115+230Vac
TM1V15E	±5<>±600mV *	±20mA	115+230Vac
TM1V15H	±5<>±600mV *	±10V	115+230Vac
TM1V165	±1<>±300V *	4...20mA	115+230Vac
TM1V16E	±1<>±300V *	±20mA	115+230Vac
TM1V16H	±1<>±300V *	±10V	115+230Vac

* In addition to the product code pls. indicate the input value corresponding to output

Auxiliary supply	Others auxiliary supply value on request
20...30VDC	Replace the 5th number (1) of the product code with C
40...60VDC	Replace the 5th number (1) of the product code with D
90...140VDC	Replace the 5th number (1) of the product code with E
180...250VDC	Replace the 5th number (1) of the product code with F

Technical features

TECHNICAL NOTES	NT238
INPUT	
Unidirectional current rating	10mV...600V
Bidirectional current rating	5mV...300V
Excessive input of short duration	20In/1s (max. 5A)
Input impedance	≥ 100kΩ with input ≤ 1V ≥ 1MΩ with input > 1V
OUTPUT	
Type	unidirectional or bidirectional, real or live zero for variable output load
Accuracy (EN 60688)	class 0,5
Current rated values	0...20 - 4...20mA
Output load	≤ 750Ω (20mA) - ≤ 1,5kΩ (10mA) - ≤ 3kΩ (5mA) ≥ 5kΩ (10V)
Voltage rated values	0...10V
Output load	> 5kΩ
Response time	≤ 300ms
AUXILIARY SUPPLY	
Rated value Uaux ac	115 and 230V
Other value on request	
Rated burden	≤5VA (Vac) ≤4W (Vdc)
MECHANICAL FEATURES	
Dimensions	6 module DIN 43880 (35mm)
Housing material	self-extinguishing polycarbonate
Protection degree	IP20 terminals/ IP51 front frame
Connections type	screw terminals
Connections	for cable up to 4mm ²
ENVIRONMENTAL CONDITIONS	
Nominal temperature range	-0...45°C
Storage and transport range	-25...70°C
Suitable for tropical climates	yes
Max.power dissipation*	≤4W

* for switchboard thermal calculation

Wiring diagrams

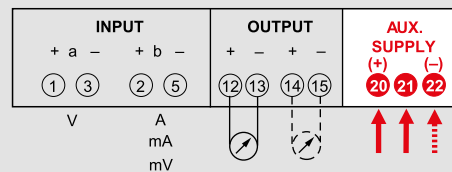

Transducers

CT with a.c. built-in transducer

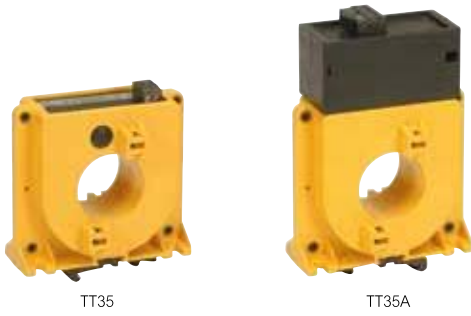

Cat. Nos.	TT35	Input	Output (mA)	Auxiliary supply
		2-wire technology Passing cable window Ø 35mm Primary current field-selectable 9 programmable ranges		
TT1AA502A		5/10/15/20/25/30/ 35/40/45	4...20	10...34Vdc
TT1AB152A		15/30/45/60/75/90/ 105/120/135A	4...20	10...34Vdc
TT1AB252A		25/50/75/100/125/150/ 175/200/225	4...20	10...34Vdc
TT1AB502A		50/100/150/200/250/300/ 350/400/450	4...20	10...34Vdc

Cat. Nos.	TT35A	Input (A)	Output	Auxiliary supply
		4-wire technology Passing cable window Ø 35mm Primary current field-selectable 9 programmable ranges		
TT1BA5012		5/10/15/20/25/30/35/40/45	0...20mA	115Vac
TT1BA5013		5/10/15/20/25/30/35/40/45	0...20mA	230Vac
TT1BA5022		5/10/15/20/25/30/35/40/45	4...20mA	115Vac
TT1BA5023		5/10/15/20/25/30/35/40/45	4...20mA	230Vac
TT1BA5032		5/10/15/20/25/30/35/40/45	0...10V	115Vac
TT1BA5033		5/10/15/20/25/30/35/40/45	0...10V	230Vac
TT1BB1512		15/30/45/60/75/90/105/120/135	0...20mA	115Vac
TT1BB1513		15/30/45/60/75/90/105/120/135	0...20mA	230Vac
TT1BB1522		15/30/45/60/75/90/105/120/135	4...20mA	115Vac
TT1BB1523		15/30/45/60/75/90/105/120/135	4...20mA	230Vac
TT1BB1532		15/30/45/60/75/90/105/120/135	0...10V	115Vac
TT1BB1533		15/30/45/60/75/90/105/120/135	0...10V	230Vac
TT1BB2512		25/50/75/100/125/150/175/200/225	0...20mA	115Vac
TT1BB2513		25/50/75/100/125/150/175/200/225	0...20mA	230Vac
TT1BB2522		25/50/75/100/125/150/175/200/225	4...20mA	115Vac
TT1BB2523		25/50/75/100/125/150/175/200/225	4...20mA	230Vac
TT1BB2532		25/50/75/100/125/150/175/200/225	0...10V	115Vac
TT1BB2533		25/50/75/100/125/150/175/200/225	0...10V	230Vac
TT1BB5012		50/100/150/200/250/300/350/400/450	0...20mA	115Vac
TT1BB5013		50/100/150/200/250/300/350/400/450	0...20mA	230Vac
TT1BB5022		50/100/150/200/250/300/350/400/450	4...20mA	115Vac
TT1BB5023		50/100/150/200/250/300/350/400/450	4...20mA	230Vac
TT1BB5032		50/100/150/200/250/300/350/400/450	0...10V	115Vac
TT1BB5033		50/100/150/200/250/300/350/400/450	0...10V	230Vac

Cat. Nos.	Accessories	Description
ATADIN01		Accessory for DIN rail 35mm mounting

Technical features

MODEL	TT35	TT35A
TECHNICAL NOTES	NT433	NT434
INPUT		
Rated current In	5...450A	
Rated frequency:	50 or 400Hz	
Working frequency:	43...63Hz	
Instantaneous overload	20 In/1 second	
OUTPUT		
Type	unidirectional, live zero for variable output load	
Accuracy	class 1	
AUXILIARY SUPPLY		
Rated value Uaux	lowest supply voltage + 9 highest supply voltage +30	115 or 230V
Rated burden	-	≤ 3VA
MECHANICAL FEATURES		
Housing material	self-extinguishing polycarbonate	
Protection degree (EN/IEC 60529)	IP20 terminals	
Mounting	screw type	
Weight	200 gr	350 gr
Connections type	removable screw terminals	
Secondary winding	2 screw terminals	4 screw terminals
ENVIRONMENTAL CONDITIONS		
Nominal temperature range	-0...45°C	
Storage and transport range	-25...70°C	
Suitable for tropical climates	yes	
Max. power dissipation*	≤ 0,6W	≤ 2,5W

*For switchboard thermal calculation

Wiring diagrams

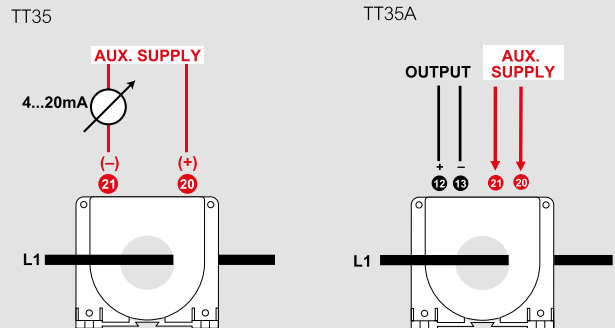

Dimensions

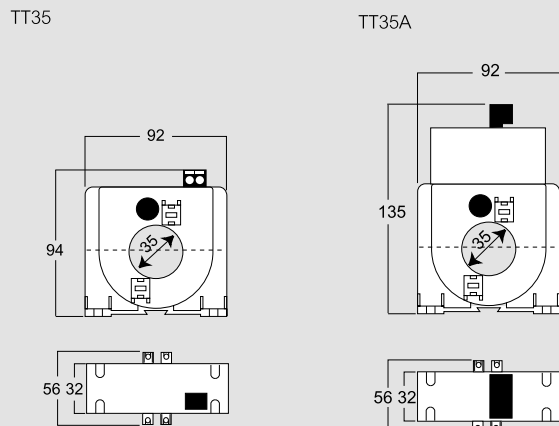

Transducers

CT with d.c. Hall effect built-in transducer



HT35Bs

HT35Bm

Cat. Nos.		HT35Bs		
Passing cable window Ø 35mm				
	Input	Output (mA)	Auxiliary supply	
HT1BS101A	10/20/30/40/50/ 60/70/80/90/100	0...20	15Vdc taken from HT35Bm *	
HT1BS102A	10/20/30/40/50/ 60/70/80/90/100	4...20	15Vdc taken from HT35Bm *	

* HT35Bm can connect up to 3 HT35Bs

Cat. Nos.		HT35Bm		
4-wire technology Passing cable window Ø 35mm				
	Input	Output (mA)	Auxiliary supply	
HT1BM1017	10/20/30/40/50/ 60/70/80/90/100	0...20	80...270Vdc 110...300Vdc	
HT1BM1017	10/20/30/40/50/ 60/70/80/90/100	0...20	20...60Vdc 24Vac	
HT1BM1017	10/20/30/40/50/ 60/70/80/90/100	4...20	80...270Vdc 110...300Vdc	
HT1BM1017	10/20/30/40/50/ 60/70/80/90/100	4...20	20...60Vdc 24Vac	

Cat. Nos.		Accessories	
IDescription			
ATADIN01	Accessory for DIN rail 35mm mounting		

Dimensions

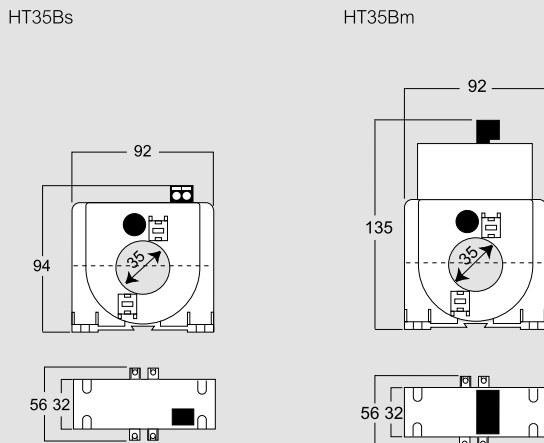

Technical features

MODEL	HT35Bs	HT35Bm
TECHNICAL NOTES	NT763	
INPUT		
Rated current In	5...100A	
Continuous overload	1,2In	
OUTPUT		
Type	unidirectional, live zero for variable output load	
Accuracy	class 1	
Current rated value	4...20mA - 0...20mA	
Output load	≤ 500Ω	
AUXILIARY SUPPLY		
Rated value Uaux	15V (from HT35Bm)	24V - 80...270V
Rated burden	≤ 1VA	
MECHANICAL FEATURES		
Housing material	self-extinguishing polycarbonate	
Protection degree (EN/IEC 60529):	IP20 terminals	
Mounting:	screw type	
Weight	110 gr	160 gr
Connections type	removable screw terminals	
ENVIRONMENTAL CONDITIONS		
Nominal temperature range	-0...45°C	
Storage and transport range	-25...70°C	
Suitable for tropical climates	yes	
Max. power dissipation*	≤ 4W	

*For switchboard thermal calculation

Wiring diagrams

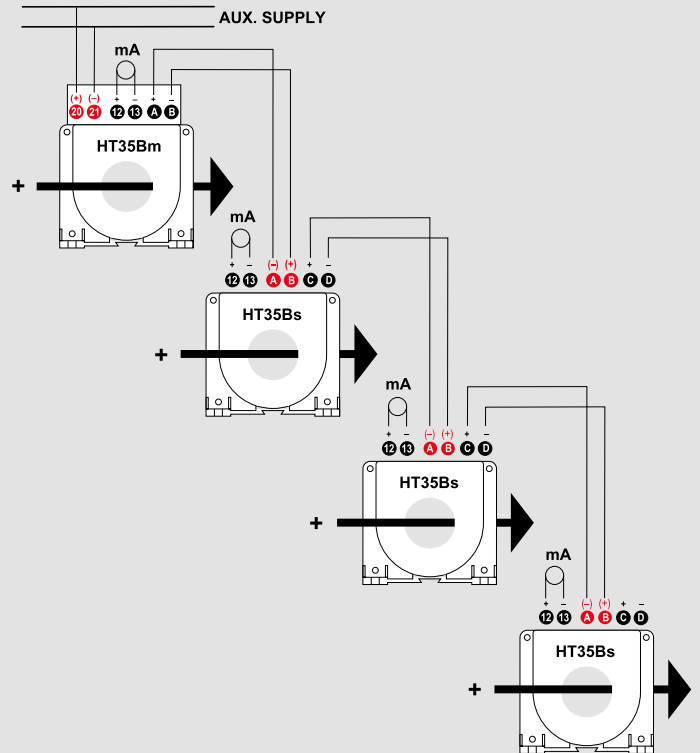

Transducers

CT with d.c. Hall effect built-in transducer



Cat. Nos. **HT35A**

Passing cable window Ø 35mm
Field-selectable output

	Input (A)	Output	Auxiliary supply
HT1BC1032	0...100	0...10V	115Vac
HT1BC1033	0...100	0...10V	230Vac
HT1BC103T	0...100	0...10V	20...150Vdc+48Vac
HT1BC1042	0...100	0...20/4...20mA	115Vac
HT1BC1043	0...100	0...20/4...20mA	230Vac
HT1BC104T	0...100	0...20/4...20mA	20...150Vdc+48Vac
HT1BC1532	0...150	0...10V	115Vac
HT1BC1533	0...150	0...10V	230Vac
HT1BC153T	0...150	0...10V	20...150Vdc+48Vac
HT1BC1542	0...150	0...20/4...20mA	115Vac
HT1BC1543	0...150	0...20/4...20mA	230Vac
HT1BC154T	0...150	0...20/4...20mA	20...150Vdc+48Vac
HT1BC2032	0...200	0...10V	115Vac
HT1BC2033	0...200	0...10V	230Vac
HT1BC203T	0...200	0...10V	20...150Vdc+48Vac
HT1BC2042	0...200	0...20/4...20mA	115Vac
HT1BC2043	0...200	0...20/4...20mA	230Vac
HT1BC204T	0...200	0...20/4...20mA	20...150Vdc+48Vac
HT1BC2532	0...250	0...10V	115Vac
HT1BC2533	0...250	0...10V	230Vac
HT1BC253T	0...250	0...10V	20...150Vdc+48Vac
HT1BC2542	0...250	0...20/4...20mA	115Vac
HT1BC2543	0...250	0...20/4...20mA	230Vac
HT1BC254T	0...250	0...20/4...20mA	20...150Vdc+48Vac
HT1BC3032	0...300	0...10V	115Vac
HT1BC3033	0...300	0...10V	230Vac
HT1BC303T	0...300	0...10V	20...150Vdc+48Vac
HT1BC3042	0...300	0...20/4...20mA	115Vac
HT1BC3043	0...300	0...20/4...20mA	230Vac
HT1BC304T	0...300	0...20/4...20mA	20...150Vdc+48Vac
HT1BC4032	0...400	0...10V	115Vac
HT1BC4033	0...400	0...10V	230Vac
HT1BC403T	0...400	0...10V	20...150Vdc+48Vac
HT1BC4042	0...400	0...20/4...20mA	115Vac
HT1BC4043	0...400	0...20/4...20mA	230Vac
HT1BC404T	0...400	0...20/4...20mA	20...150Vdc+48Vac

Cat. Nos. **Accessories**

IDescription
ATADIN01 Accessory for DIN rail 35mm mounting

Technical features

TECHNICAL NOTES	NT500
INPUT	
Rated current In	100...400A
Continuous overload	1,2In
OUTPUT	
Type	unidirectional, real or live zero for variable output load
Accuracy	class 1
Current rated value	0...20mA and 4...20mA
Output load	≤ 750Ω
Voltage rated value	0...10V
Output load	> 1kΩ
AUXILIARY SUPPLY	
Rated value Uaux ac	115 and 230V
Other value on request	
Rated burden	≤ 3,5W
MECHANICAL FEATURES	
Housing material	self-extinguishing polycarbonate
Protection degree (EN/IEC 60529)	IP20 terminals
Mounting	screw type
Weight:	350 gr
Connections type	removable screw terminals
ENVIRONMENTAL CONDITIONS	
Nominal temperature range	-0...45°C
Storage and transport range	-25...70°C
Suitable for tropical climates	yes
Max.power dissipation*	≤ 4,W

*For switchboard thermal calculation

Wiring diagrams

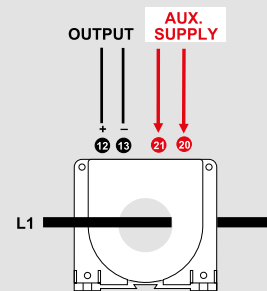

Dimensions

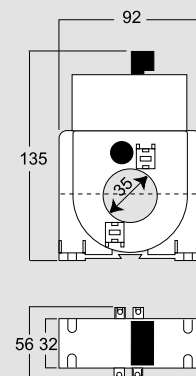

Transducers

CT with d.c. Hall effect built-in transducer



Cat. Nos. **HT80A**

Passing cable window Ø 80mm
Field-selectable output

	Input (A)	Output	Auxiliary supply
HT2BC4032	0...400	0...10V	115Vac
HT2BC4033	0...400	0...10V	230Vac
HT2BC403T	0...400	0...10V	20...150Vdc+48Vac
HT2BC4042	0...400	0...20/4...20mA	115Vac
HT2BC4043	0...400	0...20/4...20mA	230Vac
HT2BC404T	0...400	0...20/4...20mA	20...150Vdc+48Vac
HT2BC5032	0...500	0...10V	115Vac
HT2BC5033	0...500	0...10V	230Vac
HT2BC503T	0...500	0...10V	20...150Vdc+48Vac
HT2BC5042	0...500	0...20/4...20mA	115Vac
HT2BC5043	0...500	0...20/4...20mA	230Vac
HT2BC504T	0...500	0...20/4...20mA	20...150Vdc+48Vac
HT2BC6032	0...600	0...10V	115Vac
HT2BC6033	0...600	0...10V	230Vac
HT2BC603T	0...600	0...10V	20...150Vdc+48Vac
HT2BC6042	0...600	0...20/4...20mA	115Vac
HT2BC6043	0...600	0...20/4...20mA	230Vac
HT2BC604T	0...600	0...20/4...20mA	20...150Vdc+48Vac
HT2BC8032	0...800	0...10V	115Vac
HT2BC8033	0...800	0...10V	230Vac
HT2BC803T	0...800	0...10V	20...150Vdc+48Vac
HT2BC8042	0...800	0...20/4...20mA	115Vac
HT2BC8043	0...800	0...20/4...20mA	230Vac
HT2BC804T	0...800	0...20/4...20mA	20...150Vdc+48Vac
HT2BD1032	0...1000	0...10V	115Vac
HT2BD1033	0...1000	0...10V	230Vac
HT2BD103T	0...1000	0...10V	20...150Vdc+48Vac
HT2BD1042	0...1000	0...20/4...20mA	115Vac
HT2BD1043	0...1000	0...20/4...20mA	230Vac
HT2BD104T	0...1000	0...20/4...20mA	20...150Vdc+48Vac

Cat. Nos. **Accessories**

ID	Description
ATADIN01	Accessory for DIN rail 35mm mounting

Technical features

TECHNICAL NOTES	NT501
INPUT	
Rated current I _n	400...1000A
Continuous overload	1,2I _n
OUTPUT	
Type	unidirectional, real or live zero for variable output load
Accuracy	class 1
Current rated value	0...20mA and 4...20mA
Output load	≤ 750Ω
Voltage rated value	0...10V
Output load	> 1kΩ
AUXILIARY SUPPLY	
Rated value U _{aux ac}	115 and 230V
Other value on request	
Rated burden	≤5VA
MECHANICAL FEATURES	
Housing material	self-extinguishing polycarbonate
Protection degree (EN/IEC 60529):	IP20 terminals
Mounting:	screw type
Weight:	480 gr
Connections type	removable screw terminals
ENVIRONMENTAL CONDITIONS	
Nominal temperature range	-0...45°C
Storage and transport range	-25...70°C
Suitable for tropical climates	yes
Max.power dissipation*	≤4,W

*For switchboard thermal calculation

Wiring diagrams

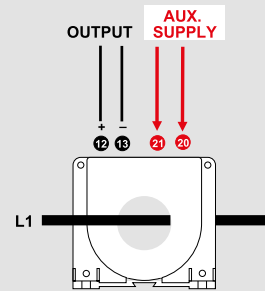

Dimensions

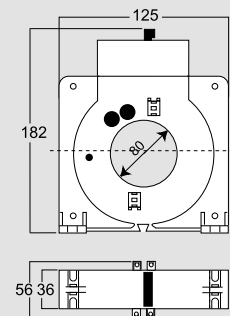

DIGITAL INDICATORS





Digital indicators

Modular digital indicators 1000 points DGM D4 series



DGMA...



DGMD...



DGMG...



DGMS...



DGMM...



DGMN...

Cat. Nos. Alternating current direct connection True RMS

Cat. Nos.	Vn (aux)	Input	Display	Output
DGMA01A3	24Vac	10A	9.99A	-
DGMA03A3	115Vac			
DGMA06A3	230Vac			
DGMA0HA3	20÷150Vdc+48Vac			
DGMA0LA3	150÷250Vdc			
DGMA01A4	24Vac	20A	20A	-
DGMA03A4	115Vac			
DGMA06A4	230Vac			
DGMA0HA4	20÷150Vdc+48Vac			
DGMA0LA4	150÷250Vdc			
DGMA21A3	24Vac	10A	9.99A	2 alarm relays
DGMA23A3	115Vac			
DGMA26A3	230Vac			
DGMA2HA3	20÷150Vdc+48Vac			
DGMA2LA3	150÷250Vdc			

Cat. Nos. Alternating voltage direct connection up to 100V or by VT with secondary 100V - True RMS

Cat. Nos.	Vn (aux)	Input	Display	Output
DGMD01D1	24Vac	100V	Primary VT 99.9V	-
DGMD03D1	115Vac			
DGMD06D1	230Vac			
DGMD0HD1	20÷150Vdc+48Vac			
DGMD0LD1	150÷250Vdc			
DGMD21D1	24Vac	100V	Primary VT 99.9V	2 alarm relays
DGMD23D1	115Vac			
DGMD26D1	230Vac			
DGMD2HD1	20÷150Vdc+48Vac			
DGMD2LD1	150÷250Vdc			

NOTE: Selectable VT primary voltages: 100/120/150/160/200/250/300/400/500/600/700/750/800V - 1/1,2/1,5/1,6/2/2,5/3/4/5/6/7/7,5/8/10/15/20/25/30/40/50/60/70/75/80/100/120/150/160/200/250kV

Cat. Nos. Network frequency

Cat. Nos.	Vn (aux)	Input	Display	Output
DGMS01F1	24Vac	100÷500V 10÷100Hz	10÷99,9Hz	-
DGMS03F1	115Vac			
DGMS06F1	230Vac			
DGMS0HF1	20÷150Vdc+48Vac			
DGMS21F1	24Vac	100÷500V 10÷100Hz	10÷99,9Hz	2 alarm relays
DGMS23F1	115Vac			
DGMS26F1	230Vac			
DGMS2HF1	20÷150Vdc+48Vac			

Cat. Nos. Alternating current by CT Alternating voltage direct connection True RMS

Cat. Nos.	Vn (aux)	Input	Display	Output
DGMG01C1	24Vac	5A-500Vac	Primary CT 500V	-
DGMG03C1	115Vac			
DGMG06C1	230Vac			
DGMG0HC1	20÷150Vdc+48Vac			
DGMG0LC1	150÷250Vdc			
DGMG01C2	24Vac	1A-500Vac	Primary CT 500V	-
DGMG03C2	115Vac			
DGMG06C2	230Vac			
DGMG0HC2	20÷150Vdc+48Vac			
DGMG0LC2	150÷250Vdc			
DGMG21C1	24Vac	5A-500Vac	Primary CT 500V	2 alarm relays
DGMG23C1	115Vac			
DGMG26C1	230Vac			
DGMG2HC1	20÷150Vdc+48Vac			
DGMG2LC1	150÷250Vdc			
DGMG21C2	24Vac			
DGMG23C2	115Vac			
DGMG26C2	230Vac			
DGMG2HC2	20÷150Vdc+48Vac			
DGMG2LC2	150÷250Vdc			

NOTE: primary currents of selectable CT: 5/10/15/20/25/30/40/50/60/70/75/80/100/120/150/160/200/250/300/400/500/600/700/750/800A - 1/1,2/1,5/1,6/2/2,5/3/4/5/6/7/7,5/8kA

Cat. Nos. Unidirectional direct current by external shunt

Cat. Nos.	Vn (aux)	Input	Display	Output
DGMM01L4	24Vac	0÷60/100/150mV	Current shunt	-
DGMM03L4	115Vac			
DGMM06L4	230Vac			
DGMM0HL4	20÷150Vdc+48Vac			
DGMM0LL4	150÷250Vdc			
DGMM21L4	24Vac	0÷60/100/150mV	Current shunt	2 alarm relays
DGMM23L4	115Vac			
DGMM26L4	230Vac			
DGMM2HL4	20÷150Vdc+48Vac			
DGMM2LL4	150÷250Vdc			

NOTE: selectable shunt currents: 5/10/15/20/25/30/40/50/60/70/75/80/100/120/150/160/200/250/300/400/500/600/700/750/800A - 1/1,2/1,5/1,6/2/2,5/3/4/5/6/7/7,5/8kA

Cat. Nos. Unidirectional direct voltage direct connection

Cat. Nos.	Vn (aux)	Input	Display	Output
DGMN01N6	24Vac	0÷60/100/150mV	0...99,9V 0...500V	-
DGMN03N6	115Vac			
DGMN06N6	230Vac			
DGMN0HN6	20÷150Vdc+48Vac			
DGMN0LN6	150÷250Vdc			
DGMN21N6	24Vac			
DGMN23N6	115Vac			
DGMN26N6	230Vac			
DGMN2HN6	20÷150Vdc+48Vac			
DGMN2LN6	150÷250Vdc			

Digital indicators

Modular digital indicators 1000 points DGM D4 series

Technical characteristics

MODEL	DGMA...	DGMD...	DGMG...	DGMS...	DGMM...	DGMN...
TECHNICAL NOTES	NT601	NT598	NT596	NT594	NT599	NT600
DISPLAY						
Type of display:	7 segments, green LED's					
Digit height:	14mm					
N° of display points:	1.000 (3 digit)					
Maximum display:	999	999	999	10...100Hz	999	999
Decimal point:	automatic	automatic	automatic	-	A or kA	V
Overrange indication:	simultaneous lighting of 3 decimal points					
Overrange:	input 12A	input > 1,2In or 1,2Un	-	-	simultaneous lighting of 3 decimal points	simultaneous lighting of 3 decimal points
Accuracy (referred to full scale):	± 1%+1 digit	± 1%+1 digit	± 1%+1 digit	± 0,1Hz	± 1%+1 digit	± 1%+1 digit
Display update:	2,9s	2,9s	2,9s	1 reading/0,8s	2,9s	2,9s
INPUT						
Connection:	direct	direct (voltage) by external CT /5A - /1A (current)	direct or by external VT	direct	from external shunt /60 - /100 - /150mV	direct
Rated voltage Un:	-	500V	100V	100...500V	-	100 - 500V
Rated current In:	10A	5A - 1A	-	-	0,02...12 In	-
Rated frequency fn:	-	-	-	50 and 60Hz	-	-
Measuring range:	0,2...12A	10...600V 0,1...6A(In 5A) - 0,02...1,2A (In 1A)	5...120V	-	-	0,02...1,2Un
Rated burden:	≤ 1VA	≤ 0.1VA - ≤ 0,6VA	≤ 0.1VA	≤ 0.1VA	-	-
Measure:	true RMS value					
Input signal waveform:	symmetric wave					
Rated frequency fn:	50Hz	50Hz	50Hz	-	-	-
Working frequency:	47...420Hz	47...420Hz	47...420Hz	10...100Hz	-	-
Input impedance:	-	-	-	-	≥ 70kΩ(150mV) - ≥ 47kΩ(100mV) - ≥ 28kΩ(60mV)	≥ 200kΩ(Un 100V) - ≥ 1MΩ(Un 500V)
Continuous overload:	12A	1,2In - 1,2Un	120V	1,2 Un	-	1,2Un
Instantaneous overload:	-	2In/5s	-	-	2In/5s	-
Form factor:	-	-	-	1.11	-	-
ALARMS						
Programmables alarms:	2 (min or max)					
Programmable set-point:	0...12A	0...120% selected range	10...100Hz	0...120% selected range	-	-
Programmables hysteresis:	0...set-point					
Delay:	programmable 1...60s					
Delay accuracy:	±10%					
Reset time:	≤ 500ms					
Output:	2 relays with SPDT contacts, potential free					
Contacts range:	5A 250Vac - 0,5A 100Vdc					
Accuracy (referred to full scale):	±1,5%					
AUXILIARY SUPPLY						
Rated value Uaux ac:	24-48-115-230-240V					
Tolerance:	±10% Uaux ac - 40...60V (Uaux 48V)					
Rated frequency:	± 50%Hz					
Working frequency:	47...63Hz					
Rated burden:	≤ 3.5VA					
Rated value Uaux dc:	20÷150Vdc-150÷250Vdc					
Rated burden:	≤ 2.5W					
ELECTROMAGNETIC COMPATIBILITY						
Emission/immunity tests according to:	EN/IEC 61326-1	EN EN 55022 (cl.B) and EN/IEC 61326-1	EN/IEC 61326-1	EN/IEC 61326-1	EN/IEC 61326-1	EN/IEC 61326-1
ENVIRONMENTAL CONDITIONS						
Nominal temperature range:	-5...55°C					
Limit range for storage and transport:	-40...70°C					
Suitable for tropical climates:	yes					
Max. power dissipation:	≤ 3.5W *					
MECHANICAL FEATURES						
Housing:	4 module DIN 43880 (35mm)					
Connections:	screw terminals					
Housing material:	self-extinguishing polycarbonate					
Protection degree (EN/IEC 60529):	IP50 front frame, IP20 terminals					

* for switchboard thermal calculation

WIRING DIAGRAMS

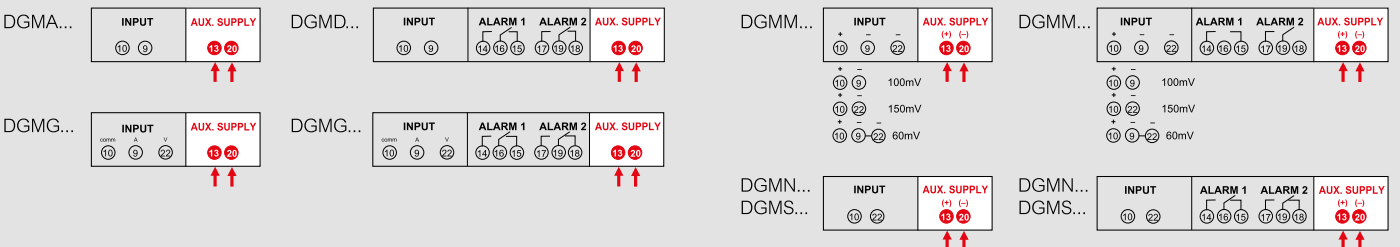

Digital indicators

Flush mounting digital indicators 2000 points DGP 36 P2k - DGP 72 P2k - DGP 96 P2k series



Completely programmable:

- Programmable input for alternating or direct voltage 500V, display in autoscaling with resolution 0,1V up to 200V and 1V over 200V.
- Programmable input for alternating or direct current 10A, display with resolution 0,01A.
- Programmable input for network frequency 10...100Hz or 380...420Hz display with resolution 0,1Hz or 1Hz respectively.
- Programmable input for alternating voltage from VT with secondary 100-110-115-120V, 23 selectable VT primary display (230/300/400/500/600/660/690/800/1000V - 3/3,3/5/5,5/6/6,6/10/11/13,8/15/20/22/30kV).
- Programmable input for alternating current from CT with secondary 1-5A, 33 selectable CT primary display (5/10/15/20/25/30/40/50/60/75/80/100/120/125/150/160/200/250/300/400/500/600/750/800/1000/1200/1250/1500/1600/2000A - 2,5/3/4kA).
- Programmable input for indirect alternating or direct voltage any value between 50 and 500V, programmable corresponding display (max indication 1999).
- Programmable input for indirect alternating or direct current any value between 1 and 10A, programmable corresponding display (max indication 1999).

Alternating current direct connection or by CT
Alternating voltage direct connection or by VT
Network frequency
Direct or indirect bidirectional direct current
Direct or indirect bidirectional direct voltage
True RMS

Cat. Nos.

DGP 36 P2k	DGP 72 P2k	DGP 96 P2k	Vn (aux)	Input	Display
DG3P03P5	DG8P03P5	DG9P03P5	115Vac	programmable	programmable (max ± 1999)
DG3P06P5	DG8P06P5	DG9P06P5	230Vac		
DG3P0MP5	DG8P0MP5	DG9P0MP5	20÷150Vdc		
			20÷60Vac		

Accessories

Cat. Nos.	Description
ADGIP543	Protection front cover IP54 for 72x36 meters
ADGIP547	Protection front cover IP54 for 96x96 meters
ADGIP549	Protection front cover IP54 for 72x72 meters
AV652	Protection front cover IP65 for 72x72 and 96x96mm meters

Technical characteristics

MODEL	DGP 36 P2K	DGP 72 P2K	DGP 96 P2K
TECHNICAL NOTES	NT874	NT877	NT878
DISPLAY			
Type of display:	7 segments, red LED's		
Digit height:	14mm		
N° of display points:	2.000 (3½ digit)		
Maximum display:	-1999...1999		
Engineering unit:	user-customizable (adhesive label)		
Polarity indication:	automatic		
Accuracy (referred to full scale):	±0,2% + 1 digit	±1% + 1 digit	±1% + 1 digit
INPUT			
Connection:	direct		
Waveform:	direct		
Rated voltage Un:	500V		
Rated current In:	10A		
Measuring range:	10...600V - 50mA...12A 10...100Hz - 380...420Hz		
Input impedance:	≤ 3,3MΩ		
Continuous overload:	1.2Un - 1.2In		
Instantaneous overload:	2Un/5s - 2UI/5s		
Voltage drop:	≤ 0,25V (10A)	≤ 0,2V (10A)	≤ 0,2V (10A)
Working voltage:	50...500V		
Measure:	true RMS value		
Waveform:	symmetric wave		
AUXILIARY SUPPLY			
Rated value Uaux ac:	115V - 230+240V - 20...60V		
Tolerance:	103...126V (Uaux.115V) - 207...253V (Uaux.230+240V) - (Uaux.20...60V)		
Rated frequency:	± 50%Hz		
Working frequency:	47...63Hz		
Rated burden:	≤ 4VA (253V)		
Rated value Uaux dc:	20...150V		
Rated burden:	≤ 3W		
ELECTROMAGNETIC COMPATIBILITY			
Emission tests according to:	EN/IEC 61326-1		
Immunity tests according to:	EN/IEC 61326-1		
ENVIRONMENTAL CONDITIONS			
Nominal temperature range:	-5...55°C		
Limit range for storage and transport:	-40...70°C		
Suitable for tropical climates	yes		
Max. power dissipation:	≤ 2W *		
MECHANICAL FEATURES			
Flush mounting panel cutout:	68x33mm	68x68mm	92x92mm
Front frame:	72x36mm (75x39mm for IP54)	72x72mm (75x75mm for IP54)	96x96mm (99x99mm for IP54)
Depth:	86mm	108mm	
Connections:	faston 6,3x0,8mm		
Housing material:	self-extinguishing polycarbonate		
Protection degree (EN/IEC 60529):	IP50 (front frame) IP20 (terminals) Option: IP54 (with kit)		

* for switchboard thermal calculation

Wiring diagrams

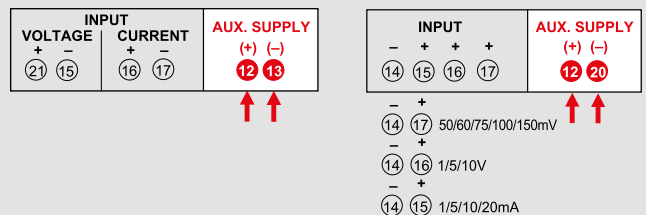

Digital indicators

Flush mounting digital indicators 2000 points - DGP 36 P2k - DGP 72 P2k - DGP 96 P2k series



Cat. Nos. Bidirectional direct current and voltage by transducers/sensors/shunt					
DGP 36 P2k	DGP 72 P2k	DGP 96 P2k	Vn (aux)	Input	Display
DG3P0NP1	DG8P0NP1	DG9P0NP1	80÷270Vac 100÷300Vdc	programmable	programmable (max ±1999)
DG3P0MP1	DG8P0MP1	DG9P0MP1	20÷150Vdc 20÷60Vac		

NOTE: programmable inputs ±1/5/10/20mA - 4...20mA - ±50/60/75/100/150mV - ±1/5/10V

Cat. Nos. Accessories	
Cat. Nos.	Description
ADGIP543	Protection front cover IP54 for 72x36 meters
ADGIP547	Protection front cover IP54 for 96x96 meters
ADGIP549	Protection front cover IP54 for 72x72 meters
AV652	Protection front cover IP65 for 72x72 and 96x96mm meters

Technical characteristics

MODEL	DGP 36 P2K	DGP 72 P2K	DGP 96 P2K
TECHNICAL NOTES	NT850	NT852	NT853
DISPLAY			
Type of display:	7 segments, red LED's		
Digit height:	14mm		
N° of display points:	2.000 (3½ digit)		
Maximum display:	-1999...1999		
Engineering unit:	user-customizable (adhesive label)		
Polarity indication:	automatic		
Accuracy (referred to full scale):	± 0,2% + 1 digit		
INPUT			
Connection:	direct		
Waveform:	direct		
Rated voltage Un:	50-60-75-100-150mV - 1-5-10V		
Rated current In:	1-5-10-20mA - 4...20mA		
Input impedance:	≥ 40kΩ - ≥ 300kSymbol		
Continuous overload:	1,2Un - 1,2In		
Instantaneous overload:	2Un/5s - 2In/5s		
Voltage drop:	≤ 1V - ≤ 200mV		
Measure:	direct current or voltage		
AUXILIARY SUPPLY			
Rated value Uaux ac:	20...60V or 80...270V		
Rated frequency:	± 50%Hz		
Working frequency:	47...63Hz		
Rated burden:	≤ 3VA	≤ 3VA	≤ 4VA (253V)
Rated value Uaux dc:	20...150V or 100...300V		
Rated burden:	≤ 3W		
ELECTROMAGNETIC COMPATIBILITY			
Emission tests according to:	EN/IEC 61326-1		
Immunity tests according to:	EN/IEC 61326-1		
ENVIRONMENTAL CONDITIONS			
Nominal temperature range	-5...55°C		
Limit range for storage and transport:	-40...70°C		
Suitable for tropical climates	yes		
Max. power dissipation:	≤ 2W *	≤ 3.6W *	≤ 3.6W *
MECHANICAL FEATURES			
Flush mounting panel cutout:	68x33mm	68x68mm	92x92mm
Front frame:	72x36mm (75x39mm for IP54)	72x72mm (75x75mm for IP54)	96x96mm (99x99mm for IP54)
Depth:	86mm	108mm	
Connections:	faston 6,3x0,8mm		
Housing material:	self-extinguishing polycarbonate		
Protection degree (EN/IEC 60529):	IP50 (front frame) IP20 (terminals) Option: IP54 (with kit)		

* for switchboard thermal calculation

Wiring diagrams

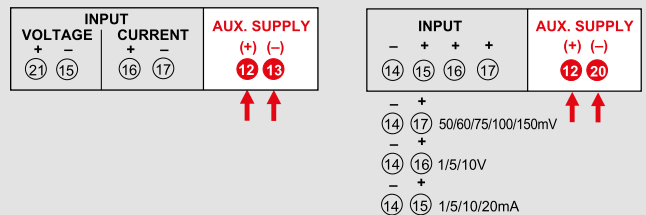

Digital indicators

Flush mounting digital indicators - DGP 96 series



DG4A...
96x48mm



DG4D...
96x48mm



DG4P... 96x48mm



DG4Q...
96x48mm

Cat. Nos. Alternating current direct connection - True RMS - 1000 points				
Cat. Nos.	Vn (aux)	Input	Display	Output
DG4A01A3	24Vac	10A	9.99A	-
DG4A03A3	115Vac			
DG4A06A3	230Vac			
DG4A0HA3	20÷150Vdc+48Vac	10A	9.99A	2 alarm relays
DG4A0LA3	150÷250Vdc			
DG4A21A3	24Vac	10A	9.99A	2 alarm relays
DG4A23A3	115Vac			
DG4A26A3	230Vac			
DG4A2HA3	20÷150Vdc+48Vac			
DG4A2LA3	20÷150Vdc			

Cat. Nos. Alternating voltage direct connection up to 100V or by VT with secondary 100V - True RMS - 1000 points				
Cat. Nos.	Vn (aux)	Input	Display	Output
DG4D01D1	24Vac	100V	Setting primary VT	-
DG4D03D1	115Vac			
DG4D06D1	230Vac			
DG4D0HD1	20÷150Vdc+48Vac			
DG4D0LD1	150÷250Vdc			
DG4D21D1	24Vac	100V	Setting primary VT	2 alarm relays
DG4D23D1	115Vac			
DG4D26D1	230Vac			
DG4D2HD1	20÷150Vdc+48Vac			
DG4D2LD1	20÷150Vdc			

NOTE: Selectable VT primary voltages: 100/120/150/160/200/250/300/400/500/600/700/750/800V - 1/1,2/1,5/1,6/2/2,5/3/4/5/6/7/7,5/8/10/15/20/25/30/40/50/60/70/75/80/100/120/150/160/200/250kV

Cat. Nos. Network frequency - 1000 points				
Cat. Nos.	Vn (aux)	Input	Display	Output
DG4S03F1	24Vac	100...500V 10...100Hz	Setting primary VT	
DG4S06F1	115Vac			
DG4S07F1	230Vac			
DG4S0HF1	20÷150Vdc+48Vac			

Cat. Nos. Bidirectional direct current and voltage by transducers/sensors/shunt - 2000 points				
Cat. Nos.	Vn (aux)	Input	Display	Output
DG4P01P2	24Vac	Program-mable	Program-mable (max ±1999)	-
DG4P03P2	115Vac			
DG4P06P2	230Vac			
DG4P0HP2	20÷150Vdc+48Vac			
DG4P0LP2	150÷250Vdc			
DG4P01P22	24Vac	Program-mable	Program-mable (max ±1999)	24Vdc (30mA)
DG4P03P22	115Vac			
DG4P06P22	230Vac			
DG4P21P2	24Vac	Program-mable	Program-mable (max ±1999)	2 alarm relays
DG4P23P2	115Vac			
DG4P26P2	230Vac			
DG4P2HP2	20÷150Vdc+48Vac			
DG4P2LP2	150÷250Vdc	Program-mable	Program-mable (max ±1999)	2 alarm relays 24Vdc (30mA)
DG4P21P22	24Vac			
DG4P23P22	115Vac			
DG4P26P22	230Vac			

NOTE: programmable inputs ±0,5...±2mA/±5...±20mA/4...20mA/±50...±200mV/±5...±20V/±50...±200V

Cat. Nos. Bidirectional direct current and voltage by transducers/sensors/shunt - 10000 points				
Cat. Nos.	Vn (aux)	Input	Display	Output
DG4Q01P2	24Vac	Program-mable	Program-mable (max 9999)	-
DG4Q03P2	115Vac			
DG4Q06P2	230Vac			
DG4Q0HP2	20÷150Vdc+48Vac			
DG4Q0LP2	150÷250Vdc			
DG4Q01P22	24Vac	Program-mable	Program-mable (max 9999)	24Vdc (30mA)
DG4Q03P22	115Vac			
DG4Q06P22	230Vac			

NOTE: Programmable inputs 0,5...2mA/5...20mA/4...20mA/50...200mV/5...20V/50...200V

Cat. Nos. Unidirectional direct current and voltage by transducers/sensors/shunt - 10000 points				
Cat. Nos.	Vn (aux)	Input	Display	Output
DG4Q21P2	24Vac	Program-mable	Program-mable (max 9999)	2 alarm relays
DG4Q23P2	115Vac			
DG4Q26P2	230Vac			
DG4Q2HP2	20÷150Vdc+48Vac			
DG4Q2LP2	150÷250Vdc			
DG4Q21P22	24Vac	Program-mable	Program-mable (max 9999)	2 alarm relay 24Vdc (30mA)
DG4Q23P22	115Vac			
DG4Q26P22	230Vac			

NOTE: Programmable inputs 0,5...2mA/5...20mA/4...20mA/50...200mV/5...20V/50...200V* Complete the code showing the display corresponding to input

Cat. Nos. Accessories	
Cat. Nos.	Description
ADGIP544	Protection front cover IP54
AV654	Protection front cover IP65

Digital indicators

Flush mounting digital indicators - DGP 96 series

Technical characteristics 96x48mm

MODEL	DG4A...	DG4D...	DG4S...	DG4P0...	DG4P2...	DG4Q0...	DG4Q2...
TECHNICAL NOTES	NT623	NT624	NT047	NT530	NT531	NT550	NT551
DISPLAY							
Type of display:	7 segments, red LED's						
Digit height:	14mm						
N° of display points:	1.000 (3 digit)	1.000 (3 digit)	1.000 (3 digit)	2.000 (3 1/2 digit)	2.000 (3 1/2 digit)	10.000 (4 digit)	10.000 (4 digit)
Maximum display:	999	999	99.9	-1999...1999	-1999...1999	9999	9999
Engineering unit:	A	V or kV	Hz	user-customizable	user-customizable	user-customizable	user-customizable
Decimal point:	automatic	automatic	fixed (00.0)	-	-	-	-
Overrange:	input 12A	input > 1,2Un	-	-	-	-	-
Accuracy (referred to full scale):	± 1% + 1 digit	± 1% + 1 digit	±0,1Hz	±(0,25% + K) + 1 digit			
Display update:	2,9s	2,9s	0.8s	3 reading/s	3 reading/s	3 reading/s	3 reading/s
INPUT							
Connection:	direct	direct or by external VT	-	direct			
Rated Voltage Un:	-	100V	100...500V	200mV – 20V – 200V			
Rated current In:	10A	-	-	20mA - 2mA			
Measuring range:	0,2...12A	5...120V	-	-Un...0...Un or -In...0...In (min) - 0...0,25Un or 0...0,25In (max)			
Rated burden:	≤ 1VA	≤ 0.1VA	≤ 0.1VA	-	-	-	-
Measure:	true RMS value		true RMS value	direct or pulsating current or voltage, average value			
Waveform:	symmetric wave		symmetric sinusoidal, form factor 1,11	direct or pulsating with frequency ≥ 50Hz			
Rated frequency:	± 50%Hz			-	-	-	-
Working frequency:	47...420Hz			-	-	-	-
Continuous overload:	12A	120V	-	1,2In – 1,2Un			
Instantaneous overload:	-	-	-	2Un/5s – 2In/5s			
ALARMS							
Programmables alarms:	2	2	-	-	2	-	2
Set-point (programmable):	0...12A	-	-	-	-1999...1999 digit	-	-1999...1999 digit
Hysteresis (programmable):	0...set-point	-	-	-	-1999...1999 digit	-	-1999...1999 digit
Delay (programmable):	1...60s	-	-	-	1...60s	-	1...60s
Delay accuracy:	±10%	-	-	-	±10%	-	±10%
Reset time:	≤ 500ms	-	-	-	≤ 500ms	-	≤ 500ms
Output:	2 relays with SPDT contacts, potential free		-	-	2 relays with SPDT contacts, voltage free		2 relays with SPDT contacts, voltage free
Contacts range:	5A 250Vac – 0,5A 100Vdc		-	-	5A 250Vac – 0,5A 100Vdc		5A 250Vac – 0,5A 100Vdc
Accuracy (referred to full scale):	±1,5%	±1,5%	-	-	2 (0,25%+K)+ 1 digit		2 (0,25%+K)+ 1 digit
AUXILIARY SUPPLY							
Rated value Uaux ac:	24 – 48 – 115 – 230 – 240V						
Tolerance:	±10% Uaux ca – 40...60V (Uaux 48V)						
Rated frequency:	± 50%Hz						
Working frequency:	47...63Hz						
Rated burden:	≤ 3.5VA			≤ 4.5VA			
Rated value Uaux dc:	20...150Vdc – 150...250Vdc						
Rated burden:	≤ 2.5W			≤ 3W			
ELECTROMAGNETIC COMPATIBILITY							
Emission tests according to:	EN/IEC 61326-1						
Immunity tests according to:	EN/IEC 61326-1						
ENVIRONMENTAL CONDITIONS							
Nominal temperature range:	-5...55°C						
Limit range for storage and transport:	-40...70°C						
Suitable for tropical climates	yes						
Max. power dissipation:	≤ 3.5W *			≤ 3.6W *			
MECHANICAL FEATURES							
Housing:	flush mounting (panel cutout 92x45mm)						
Front frame:	96x48mm (99x52mm with IP54 protection)						
Depth:	162mm						
Connections:	faston 6,3x0,8mm						
Housing material:	self-extinguishing polycarbonate						
Protection degree (EN/IEC 60529):	IP50 (front frame) IP20 (terminals) - Option: IP54 protection degree (with kit ADGIP544)						

* for switchboard thermal calculation

Wiring diagrams

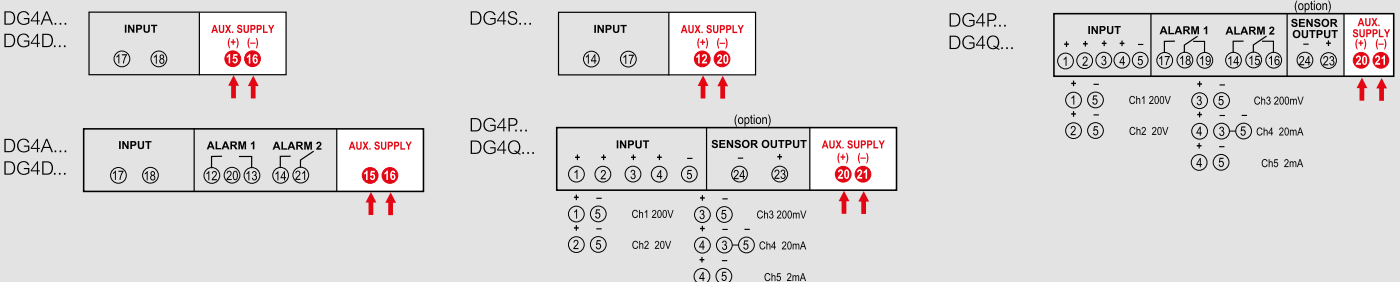

Digital indicators

Flush mounting digital indicators 1000 points - DGP 96 - DGQ72 series



DGP 96
96x48mm



DGQ72
72x72mm

Cat. Nos.		Alternating current measurement by CT Alternating voltage direct connection True RMS			
DGP 96	DGQ72	Vn (aux)	Input	Display	Output
DG4G01C1		24Vac	5A - 500V	Setting primary CT	-
DG4G03C1		115Vac			
DG4G06C1		230Vac			
DG4G0HC1		20÷150Vdc+48Vac			
DG4G0LC1		150÷250Vdc			
DG4G01C2		24Vac	1A - 500V	Setting primary CT	-
DG4G03C2		115Vac			
DG4G06C2		230Vac			
DG4G0HC2		20÷150Vdc+48Vac			
DG4G0LC2		150÷250Vdc			
DG4G21C1	DG7G21C1	24Vac	5A - 500V	Setting primary CT	2 alarm relays
DG4G23C1	DG7G23C1	115Vac			
DG4G26C1	DG7G26C1	230Vac			
DG4G2HC1	DG7G2HC1	20÷150Vdc+48Vac			
DG4G2LC1	DG7G2LC1	20÷150Vdc			
DG4G21C2	DG7G21C2	24Vac	1A - 500V	Setting primary CT	2 alarm relays
DG4G23C2	DG7G23C2	115Vac			
DG4G26C2	DG7G26C2	230Vac			
DG4G2HC2	DG7G2HC2	20÷150Vdc+48Vac			
DG4G2LC2	DG7G2LC2	20÷150Vdc			

NOTE: Selectable shunt currents 5/10/15/20/25/30/40/50/60/70/75/80/100/120/150/160/200/250/300/400/500/600/700/750/800A - 1/1,2/1,5/1,6/2/2,5/3/4/5/6/7/7,5/8kA

Technical characteristics

MODEL	DGQP96	DGQ 72
TECHNICAL NOTES	NT533	NT602
DISPLAY		
Type of display:	7 segments, red LED's	
Digit height:	14mm	
N° of display points:	1.000 (3 digit)	
Maximum display:	999	
Engineering unit:	A or kA or V	
Decimal point:	automatic	
Overrange:	input > 1,2In or 1,2Un	
Accuracy (referred to full scale):	± 1% + 1 digit	
Display update:	2,9s	
INPUT		
Connection:	direct or by external CT /5A - /1A	
Rated Voltage Un:	500V	
Rated current In:	5A - 1A	
Measuring range:	10...600V - 0,1...6A (In 5A) 0,02...1,2A (In1A)	
Rated burden:	≤ 0.1VA (Un) - ≤ 0.6VA (In)	
Measure:	true RMS value	
Waveform:	symmetric wave	
Rated frequency:	± 50%Hz	
Working frequency:	47...420Hz	
Continuous overload:	1,2In - 1,2Un	
Instantaneous overload:	2In/5s	
ALARMS		
Programmables alarms:	2	
Set-point (programmable):	0...120% selected range	
Hysteresis (programmable):	0...set-point	
Delay (programmable):	1...60s	
Delay accuracy:	±10%	
Reset time:	≤ 500ms	
Output:	2 relays with SPDT contacts, potential free	
Contacts range:	5A 250Vac - 0,5A 100Vdc	
Accuracy (referred to full scale):	±1,5%	
AUXILIARY SUPPLY		
Rated value Uaux ac:	24-48-115-230-240V	
Tolerance:	±10% Uaux ac - 40...60V (Uaux 48V)	
Rated frequency:	± 50%Hz	
Working frequency:	47...63Hz	
Rated burden:	≤ 3.5VA	
Rated value Uaux dc:	20...150Vdc - 150...250Vdc	
Rated burden:	≤ 2.5W	
ELECTROMAGNETIC COMPATIBILITY		
Emission tests according to:	EN/IEC 61326-1	
Immunity tests according to:	EN/IEC 61326-1	
ENVIRONMENTAL CONDITIONS		
Nominal temperature range	-5...55°C	
Limit range for storage and transport:	-40...70°C	
Suitable for tropical climates	yes	
Max. power dissipation:	≤ 3.5W *	≤ 3.5W *
MECHANICAL FEATURES		
Flush mounting panel cutout:	92x45mm	68x68mm
Front frame:	96x48mm (99x52mm for IP54)	72x72mm (75x75mm for IP54)
Depth:	162mm	108mm
Connections:	faston 6,3x0,8mm	
Housing material:	self-extinguishing polycarbonate	
Protection degree (EN/IEC 60529):	IP50 (front frame) IP20 (terminals) - Option: IP54 (with kit)	

* for switchboard thermal calculation

Wiring diagrams

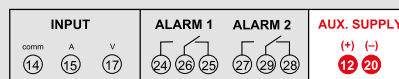
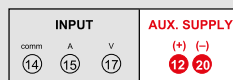

Digital indicators

Flush mounting digital indicators 1000 points - DGP 96 - DGQ72 series



DGP 96
96x48mm



DGQ72
72x72mm

Unidirectional direct current by external shunt

Cat. Nos.		Vn (aux)	Input	Display	Output
DGP 96	DGQ72	24Vac	0...60/100 /150mV	Current shunt	-
DG4M01L4		115Vac			
DG4M03L4		230Vac			
DG4M06L4		20÷150Vdc+48Vac			
DG4M0HL4		150÷250Vdc			
DG4M0LL4					
DG4M21L4	DG7M21L4	24Vac	0...60/100 /150mV	Current shunt	2 alarm relays
DG4M23L4	DG7M23L4	115Vac			
DG4M26L4	DG7M26L4	230Vac			
DG4M2HL4	DG7M2HL4	20÷150Vdc+48Vac			
DG4M2LL4	DG7M2LL4	20÷150Vdc			

NOTE: Selectable shunt currents 5/10/15/20/25/30/40/50/60/70/75/80/100/120/150/160/200/250/300/400/500/600/700/750/800A - 1/1,2/1,5/1,6/2/2,5/3/4/5/6/7/7,5/8kA

Accessories

Cat. Nos.	Description
ADGIP544	Protection front cover IP54 for 96x48mm meters
AV654	Protection front cover IP65 for 96x48mm meters
ADGIP547	Protection front cover IP54 for 72x72mm meters
AV652	Protection front cover IP65 for 72x72mm meters

Technical characteristics

MODEL	DGQP96	DGQ 72
TECHNICAL NOTES	NT626	NT607
DISPLAY		
Type of display:	7 segments, red LED's	
Digit height:	14mm	
N° of display points:	1.000 (3 digit)	
Maximum display:	999	
Engineering unit:	A or kA	
Decimal point:	automatic	
Overrange:	input > 1,2In	
Accuracy (referred to full scale):	± 1% + 1 digit	
Display update:	2,9s	
INPUT		
Connection:	from external shunt /60 - /100 - /150mV	
Measuring range:	0,02...12In	
Input impedance:	≥ 70kΩ(150mV) - > 47kΩ(100mV) ≥ 28kΩ(60mV)	
Instantaneous overload:	2In/5s	
ALARMS		
Programmables alarms:	2	
Set-point (programmable):	0...120% selected range	
Hysteresis (programmable):	0...set-point	
Delay (programmable):	1...60s	
Delay accuracy:	±10%	
Reset time:	≤ 500ms	
Output:	2 relays with SPDT contacts, potential free	
Contacts range:	5A 250Vac - 0,5A 100Vdc	
Accuracy (referred to full scale):	±1,5%	
AUXILIARY SUPPLY		
Rated value Uaux ac:	24 - 48 - 115 - 230 - 240V	
Tolerance:	±10% Uaux ca - 40...60V (Uaux 48V)	
Rated frequency:	± 50%Hz	
Working frequency:	47...63Hz	
Rated burden:	≤ 3,5VA	
Rated value Uaux dc:	20...150Vdc - 150...250Vdc	
Rated burden:	≤ 2,5W	
ELECTROMAGNETIC COMPATIBILITY		
Emission tests according to:	EN/IEC 61326-1	
Immunity tests according to:	EN/IEC 61326-1	
ENVIRONMENTAL CONDITIONS		
Nominal temperature range:	-5...55°C	
Limit range for storage and transport:	-40...70°C	
Suitable for tropical climates	yes	
Max. power dissipation:	≤ 3,5W *	≤ 2,5W *
MECHANICAL FEATURES		
Flush mounting panel cutout:	92x45mm	68x68mm)
Front frame:	96x48mm (99x52mm for IP54)	72x72mm (75x75mm for IP54)
Depth:	162mm	
Connections:	faston 6,3x0,8mm	
Housing material:	self-extinguishing polycarbonate	
Protection degree (EN/IEC 60529):	IP50 (front frame) IP20 (terminals) - Option: IP54 (with kit)	

* for switchboard thermal calculation

Wiring diagrams

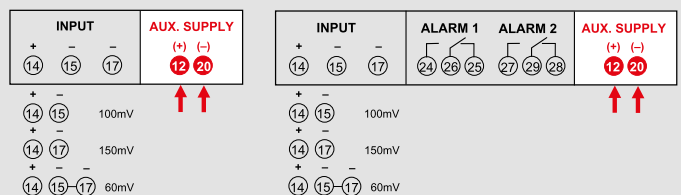

Digital indicators

Flush mounting digital indicators 1000 points - DGP 96 - DGQ72 series



DG4N...
96x48mm



DG7N...
72x72mm

Unidirectional direct voltage direct connection

Cat. Nos.		Vn (aux)	Input	Display	Output
DGP 96	DGQ72	24Vac	0÷100V	0÷99.9V	-
DG4N01N6		115Vac	0÷500V	0÷500V	-
DG4N03N6		230Vac			
DG4N06N6		20÷150Vdc+48Vac			
DG4N0HN6		150÷250Vdc			
DG4N0LN6					
DG4N21N6	DG7N21N6	24Vac	0÷100V	0÷99.9V	2 alarm relays
DG4N23N6	DG7N23N6	115Vac	0÷500V	0÷500V	
DG4N26N6	DG7N26N6	230Vac			
DG4N2HN6	DG7N2HN6	20÷150Vdc+48Vac			
DG4N2LN6	DG7N2LN6	150÷250Vdc			

Accessories

Cat. Nos.	Description
ADGIP544	Protection front cover IP54 for 96x48mm meters
AV654	Protection front cover IP65 for 96x48mm meters
ADGIP547	Protection front cover IP54 for 72x72mm meters
AV652	Protection front cover IP65 for 72x72mm meters

Technical characteristics

MODEL	DGQP96	DGQ 72
TECHNICAL NOTES	NT625	NT608
DISPLAY		
Type of display:	7 segments, red LED's	
Digit height:	14mm	
N° of display points:	1.000 (3 digit)	
Maximum display:	999	
Engineering unit:	V	
Decimal point:	automatic	
Overrange:	input > 1,2Un	
Accuracy (referred to full scale):	± 1% + 1 digit	
Display update:	2,9s	
INPUT		
Connection:	direct	
Rated Voltage Un:	100 – 500V	
Measuring range:	0,02...1,2Un	
Input impedance:	≥ 200kΩ(Un 100V) - ≥ 1MΩ(Un 500V)	
Continuous overload:	1,2Un	
ALARMS		
Programmables alarms:	2	
Set-point (programmable):	0...120% selected range	
Hysteresis (programmable):	0...set-point	
Delay (programmable):	1...60s	
Delay accuracy:	±10%	
Reset time:	≤ 500ms	
Output:	2 relays with SPDT contacts, potential free	
Contacts range:	5A 250Vac – 0,5A 100Vdc	
Accuracy (referred to full scale):	±1,5%	
AUXILIARY SUPPLY		
Rated value Uaux ac:	24 – 48 – 115 – 230 – 240V	
Tolerance:	±10% Uaux ca – 40...60V (Uaux 48V)	
Rated frequency:	± 50%Hz	
Working frequency:	47...63Hz	
Rated burden:	≤ 3.5VA	
Rated value Uaux dc:	20...150Vdc – 150...250Vdc	
Rated burden:	≤ 2.5W	
ELECTROMAGNETIC COMPATIBILITY		
Emission tests according to:	EN/IEC 61326-1	
Immunity tests according to:	EN/IEC 61326-1	
ENVIRONMENTAL CONDITIONS		
Nominal temperature range	-5...55°C	
Limit range for storage and transport:	-40...70°C	
Suitable for tropical climates	yes	
Max. power dissipation:	≤ 3.5W	≤ 3.5W
MECHANICAL FEATURES		
Flush mounting panel cutout:	92x45mm	68x68mm)
Front frame:	96x48mm (99x52mm for IP54)	72x72mm (75x75mm for IP54)
Depth:	162mm	108mm
Connections:	faston 6,3x0,8mm	
Housing material:	self-extinguishing polycarbonate	
Protection degree (EN/IEC 60529):	IP50 (front frame) IP20 (terminals) - Option: IP54 (with kit)	

* for switchboard thermal calculation

Wiring diagrams

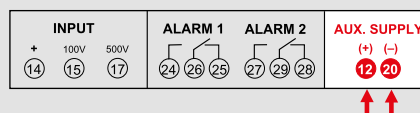
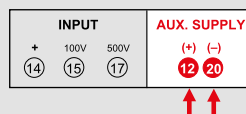

Digital indicators

Flush mounting digital bargraph - LD 24 series



DG7N...
72x72mm

Cat. Nos.

Ammeter digital bargraph for direct current

Bidirectional direct current measurements
Display any proportional process variable
Input for standard signal: 1 - 5 - 10 - 20mA - 4...20mA

Vertical	Horizontal	Vn (aux)	Input	Display
LD201BGA11	LD201BGA13	18...36Vdc	0...1mA	0...100%
LD201BGB11	LD201BGB13		±1mA	±100%
LD201BGC11	LD201BGC13		0...5mA	0...100%
LD201BGD11	LD201BGD13		±5mA	±100%
LD201BGE11	LD201BGE13		0...10mA	0...100%
LD201BGF11	LD201BGF13		±10mA	±100%
LD201BGG11	LD201BGG13		0...20mA	0...100%
LD201BGH11	LD201BGH13		±20mA	±100%
LD201BGL11	LD201BGL13		4...20mA	0...100%

Cat. Nos.

Voltmeter digital bargraph for direct current

Bidirectional direct voltage measurements
Display any proportional process variable
Input for standard signal: 5 - 10V - 1...5 - 2...10V

Vertical	Horizontal	Vn (aux)	Input	Display
LD202BNC11	LD202BNC13	18...36Vdc	0...5V	0...100%
LD202BND11	LD202BND13		±5V	±100%
LD202BNE11	LD202BNE13		0...10V	0...100%
LD202BNF11	LD202BNF13		±10V	±100%
LD202BNG11	LD202BNG13		1...5V	0...100%
LD202BNH11	LD202BNH13		2...10V	0...100%

Technical characteristics

MODEL	DIRECT CURRENT	DIRECT VOLTAGE
TECHNICAL NOTES	NT026	NT025
DISPLAY		
Type of display:	red LED's bargraph, 30 segments	
Segment size:	2x5mm	
Scale length:	75mm	
Bar position:	horizontal or vertical	
Scale marking:	0...100% - 100...0...100%	
Overrange indication:	blinking of last 10 segments	
Response time:	≤ 100ms	
Accuracy:	± 1 segment	
INPUT DIRECT VOLTAGE		
Connection:	direct	
Rated voltage Un:	-	5-10 -1...5 - 2...10V
Rated current In:	1-5-10-20 4...20mA	-
Measuring range:	0...In or -In...0...In	0...Un or -Un...0...Un
Input impedance:	-	≥ 10MΩ (Un ≤ 2V) - ≥ 300kΩ (Un > 2V)
Continuous overload:	2In	1.2Un
Instantaneous overload:	10In/5s	2Un/5s
Voltage drop:	400mV (In ≤ 20mA) ≤ 200mV (In > 20mA and 4...20mA)	-
AUXILIARY SUPPLY		
Rated value Uaux ac:	18...36Vdc	
Rated burden:	≤ 2W	
ELECTROMAGNETIC COMPATIBILITY		
Emission tests according to:	EN/IEC 61326-1	
Immunity tests according to:	EN/IEC 61326-1	
ENVIRONMENTAL CONDITIONS		
Nominal temperature range	-5...55°C	
Limit range for storage and transport:	-40...70°C	
Suitable for tropical climates	yes	
Max. power dissipation:	≤ 2W *	
MECHANICAL FEATURES		
Housing:	flush mounting (panel cutout 92x22,2mm)	
Front frame:	96x24mm	
Depth:	94mm	
Connections:	fast-on 3x0,8mm	
Housing material:	self-extinguishing polycarbonate	
Protection degree (EN/IEC 60529):	IP50 (front frame) IP20 (terminals)	

* for switchboard thermal calculation

Wiring diagrams

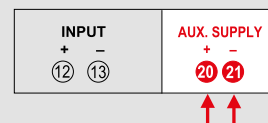







ANALOGUE INDICATORS





Analog indicators

Flush mounting analog meters RQ series

MEASURING	ALTERNATING CURRENT (AC)		DIRECT CURRENT (DC)		ALTERNATING CURRENT
 RQ48 - 48x48mm RQ72 - 72x72mm RQ96 - 96x96mm					
Type	Ammeters	Voltmeters	Ammeters	Voltmeters	Frequency meters
Technical notes	NT755	NT759	NT760	NT762	NT787
DISPLAY					
Scale	interchangeable				
Scale length	90°				
Standard scale marking	0...In	0...Un	-In...0...In	-Un...0...Un	45...55Hz - 55...65Hz - 45...65Hz
Motor startup marking scale	0...In...2In or 0...In...5In	-	-	-	-
INPUT					
Connection	direct or external CT	direct or external VT	direct or external shunt	direct or external shunt	direct
Measure	true RMS value				frequency
Rating current In (direct)	1...100A	-	50µA...60A (40A for RQ48M)	-	-
Rating current In (CT connection)	5A or 1A	-	1A/60mV... 6000A/60mV	-	-
Rating current In (shunt connection)	-	-	1...600mA	-	-
Rating voltage Un (direct)	-	10...600V	-	10...600V	-
Rating voltage Un (VT connection)	-	VT/100V - VT/110V	-	50...500mV	-
Rating voltage Un (transducers)	-	-	-	5 - 10V	-
Continuous overload	1,2In	1,2Un	1,2In	1,2Un	-
Instantaneous overload	10In/5s	10Un/5s	10In/5s	10Un/5s	-
-Voltage drop	-	-	from 700mV (In=50 µA) up to 60mV (In=10mA...60A)	-	-
Rating frequency fn	50Hz (400Hz in option)		-	-	-
Working frequency	45...65Hz		-	-	-
Accuracy (EN/IEC 60051)	class 1,5 (accuracy class1 in option)				class 0,5 class 1 (45...65Hz)
Rated burden	≤ 1,1VA	≤ 3,5VA (500V) - ≤ 3VA (300V)	-	10mA with Un - 60...300mV 1mA (1kΩ/V) with Un 0,5...600V	≤ 4VA
NOMINAL RANGE					
Voltage	-				
Current	-				
Power factor	-				
Waveform	-				
MEASURING RANGE					
Active power	-				
Reactive power	-				
Power of calibration Pc (Qc)	-				
Cosφ	-				
INSULATION (EN/IEC 61010-1)					
Installation category	III				
Pollution degree	2				
Insulation voltage rating	600V (Phase - Neutral)				
A.C. voltage test (current input towards voltage input and output)	-				
A.C. voltage test (all circuits and earth)	4kV r.m.s. 50Hz/5s				
ENVIRONMENTAL CONDITIONS					
Nominal temperature range	5...40°C				
Limit range for storage and transport	-40...80°C				
Vibration test according to	EN/IEC 60051-1				
Shock test according to	EN/IEC 60051-1				
Max. power dissipation	-				
MECHANICAL FEATURES					
Mounting	flush mounting				
Housing material	self-extinguishing polycarbonate				
Connections	screw terminal / fast-on 6,3 x 0,8mm				
Protection degree (EN/IEC 60529)	IP52 front frame (IP54 in option), IP20 terminals (with protection)				
Weight	120gr (RQ48) - 190gr (RQ72) - 260gr (RQ96)				

ANALOG METERS



Thermal ammeters
NT770

Thermal-magnetic ammeters
NT764

Power meters
NT701

Cosφ meters
NT705

interchangeable

90°

upon request

0...1,2In

0...In

by external CT /5A

direct connection or by external VT/CT

thermal current

thermal current

5A

1 - 5A

100-110-230-240-400-415-440V (ph-ph)

1,2In

In - Un

10In/5s

2In/5s - 2Un/5s

In and 2Un/5s
Un and 2In/0,5s

50Hz

45..65Hz

45..65Hz

47...63Hz

class 1,5
(accuracy class
1 in option)

class 1,5
(instantaneous
current) - class 3
(thermal current)

class 1,5

≤ 2,5VA

voltage ≤ 1VA - current ≤ 0,5VA

85...115%Un (max. 450V)

0...120%In

cosφ 0,5 inductive
senf 0,5 inductive

sinusoidal, distortion factor < 20%

-Pn...0...Pn

-Qn...0...Qn

0,6...1,2Pn (Qn)

0,5 inductive
1...0,5 capacitive

III

2

600V (Phase - Neutral)

300V (Phase - Neutral)

2,5kV r.m.s. 50Hz/1min

4kV r.m.s. 50Hz/1min

5...40°C

0...40°C

-40...80°C

-10...55°C

EN/IEC 60051-1

EN62052-11

EN/IEC 60051-1

EN62052-11

≤ 3,6W

flush mounting

self-extinguishing polycarbonate

screw terminal / fast-on 6,3 x 0,8mm

IP52 front frame (IP54 in option), IP20 terminals (with protection)

120gr (RQ48) - 190gr (RQ72) - 260gr (RQ96)

Wiring diagrams

Ammeter

AC measuring



DC measuring

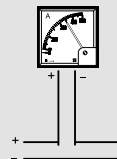

AC measuring

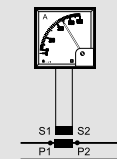

DC measuring

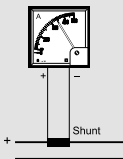

Voltmeter

AC measuring



DC measuring

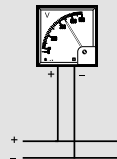

AC measuring

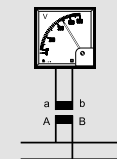

DC measuring

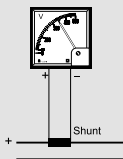

Thermal ammeter

RQ48T
RQ72T
RQ96T



RQ72TE
RQ96TE

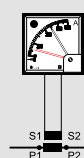

Frequency meter



Power meter

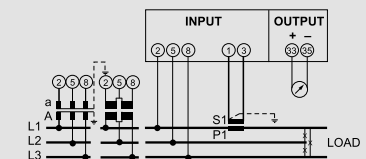
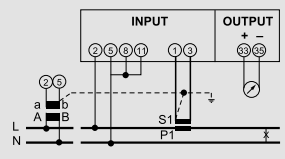

Cosφ meter

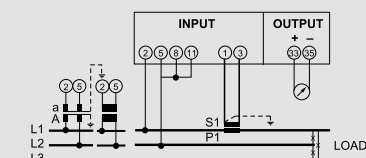
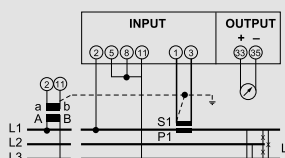

Dimensions

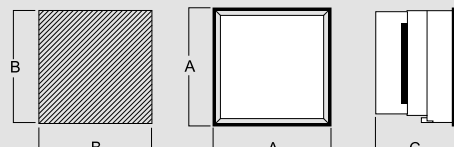

Dim. (mm)	A	B	C
RQ48...	48x48	45x45	75
RQ72...	72x72	68x68	69
RQ96...	96x96	92x92	69

Analog indicators

Flush mounting analog meters for alternating current and voltage RQ series



Cat. Nos.			Alternating current ammeters by CT	
			Direct indication of input current or primary current of external CT	
			Moving iron equipment	
			Input by external CT /5A or /1A	
			Version for starting motor 2In or 5In	
			Scale length 90° - Accuracy class 1,5	
RQ48E	RQ72E	RQ96E	Input	Scale
AN12510000	AN22510000	AN32510000	-/5A	*
AN12D1A500	AN22D1A500	AN32D1A500	5/5A	0...5A
AN1251B100	AN2251B100	AN3251B100	10/5A	0...10A
AN1251B150	AN2251B150	AN3251B150	15/5A	0...15A
AN1251B200	AN2251B200	AN3251B200	20/5A	0...20A
AN1251B250	AN2251B250	AN3251B250	25/5A	0...25A
AN1251B300	AN2251B300	AN3251B300	30/5A	0...30A
AN1251B400	AN2251B400	AN3251B400	40/5A	0...40A
AN1251B500	AN2251B500	AN3251B500	50/5A	0...50A
AN1251B600	AN2251B600	AN3251B600	60/5A	0...60A
AN1251B700	AN2251B700	AN3251B700	70/5A	0...70A
AN1251B750	AN2251B750	AN3251B750	75/5A	0...75A
AN1251B800	AN2251B800	AN3251B800	80/5A	0...80A
AN1251C100	AN2251C100	AN3251C100	100/5A	0...100A
AN1251C120	AN2251C120	AN3251C120	120/5A	0...120A
AN1251C125	AN2251C125	AN3251C125	125/5A	0...125A
AN1251C150	AN2251C150	AN3251C150	150/5A	0...150A
AN1251C160	AN2251C160	AN3251C160	160/5A	0...160A
AN1251C200	AN2251C200	AN3251C200	200/5A	0...200A
AN1251C250	AN2251C250	AN3251C250	250/5A	0...250A
AN1251C300	AN2251C300	AN3251C300	300/5A	0...300A
AN1251C400	AN2251C400	AN3251C400	400/5A	0...400A
AN1251C500	AN2251C500	AN3251C500	500/5A	0...500A
AN1251C600	AN2251C600	AN3251C600	600/5A	0...600A
AN1251C700	AN2251C700	AN3251C700	700/5A	0...700A
AN1251C750	AN2251C750	AN3251C750	750/5A	0...750A
AN1251C800	AN2251C800	AN3251C800	800/5A	0...800A
AN1251D100	AN2251D100	AN3251D100	1000/5A	0...1000A
AN1251D120	AN2251D120	AN3251D120	1200/5A	0...1,2kA
AN1251D125	AN2251D125	AN3251D125	1250/5A	0...1,25kA
AN1251D150	AN2251D150	AN3251D150	1500/5A	0...1,5kA
AN1251D160	AN2251D160	AN3251D160	1600/5A	0...1,6kA
AN1251D200	AN2251D200	AN3251D200	2000/5A	0...2kA
AN1251D250	AN2251D250	AN3251D250	2500/5A	0...2,5kA
AN1251D300	AN2251D300	AN3251D300	3000/5A	0...3kA
AN1251D400	AN2251D400	AN3251D400	4000/5A	0...4kA
AN1251D500	AN2251D500	AN3251D500	5000/5A	0...5kA
AN1251D600	AN2251D600	AN3251D600	6000/5A	0...6kA
AN1251D800	AN2251D800	AN3251D800	8000/5A	0...8kA
AN1251E100	AN2251E100	AN3251E100	10000/5A	0...10kA

Other executions available
2In overscale: Replace the 6th number (1) of product code with 2
5In overscale: Replace the 6th number (1) of product code with 5
CT /1A connection: Replace the 5th number (5 or D) of product code with 1

Note 1 - in addition to the Cat. Nos. indicate the scale and the VT ratio. The ladder should correspond to the product of the input value selected and the TV report
Note 2 - in addition to the product code indicate the scale and the VT ratio

Cat. Nos.			Alternating current ammeters direct connection	
			Input	Scale
RQ48E	RQ72E	RQ96E		
AN12D1A100	AN22D1A100	AN32D1A100		0...1A
AN12D1A150	AN22D1A150	AN32D1A150		0...1.5A
AN12D1A200	AN22D1A200	AN32D1A200		0...2A
AN12D1A250	AN22D1A250	AN32D1A250		0...2.5A
AN12D1A300	AN22D1A300	AN32D1A300		0...3A
AN12D1A400	AN22D1A400	AN32D1A400		0...4A
AN12D1A500	AN22D1A500	AN32D1A500		0...5A
AN12D1A600	AN22D1A600	AN32D1A600		0...6A
AN12D1B100	AN22D1B100	AN32D1B100	direct	0...10A
AN12D1B150	AN22D1B150	AN32D1B150		0...15A
AN12D1B200	AN22D1B200	AN32D1B200		0...20A
AN12D1B250	AN22D1B250	AN32D1B250		0...25A
AN12D1B300	AN22D1B300	AN32D1B300		0...30A
AN12D1B400	AN22D1B400	AN32D1B400		0...40A
AN12D1B500	AN22D1B500	AN32D1B500		0...50A
AN12D1B600	AN22D1B600	AN32D1B600		0...60A
AN12D1B800	AN22D1B800	AN32D1B800		0...80A
AN22D1C100	AN22D1C100	AN32D1C100		0...100A

Other executions available
2In overscale: Replace the 6th number (1) of product code with 2
5In overscale: Replace the 6th number (1) of product code with 5

Cat. Nos.			Alternating voltage voltmeters by VT	
			Direct indication of input voltage or primary voltage of external VT	
			Moving iron equipment	
			Input by external VT /100V - /110V	
			Scale length 90° - Accuracy class 1,5	
RQ48E	RQ72E	RQ96E	Input	Scale
AN15111111	AN25111111	AN35111111	0...100V	note1
AN15211111	AN25211111	AN35211111	0...120V	note1
AN15311111	AN25311111	AN35311111	0...125V	note1
AN15411111	AN25411111	AN35411111	0...131.58V	note1
AN15511111	AN25511111	AN35511111	0...133.33V	note1
AN15611111	AN25611111	AN35611111	0...136.36V	note1
AN15711111	AN25711111	AN35711111	0...150V	note1
AN15P11111	AN25P11111	AN35P11111	other values	note 2

Cat. Nos.			Alternating voltage voltmeters direct connection	
			Input	Scale
RQ48E	RQ72E	RQ96E		
AN15DDB100	AN25DDB100	AN35DDB100		0...10V
AN15DDB150	AN25DDB150	AN35DDB150		0...15V
AN15DDB250	AN25DDB250	AN35DDB250		0...25V
AN15DDB300	AN25DDB300	AN35DDB300		0...30V
AN15DDB400	AN25DDB400	AN35DDB400		0...40V
AN15DDB600	AN25DDB600	AN35DDB600		0...60V
AN15DDC100	AN25DDC100	AN35DDC100	direct	0...100V
AN15DDC150	AN25DDC150	AN35DDC150		0...150V
AN15DDC200	AN25DDC200	AN35DDC200		0...200V
AN15DDC250	AN25DDC250	AN35DDC250		0...250V
AN15DDC300	AN25DDC300	AN35DDC300		0...300V
AN15DDC400	AN25DDC400	AN35DDC400		0...400V
AN15DDC500	AN25DDC500	AN35DDC500		0...500V
AN15DDC600	AN25DDC600	AN35DDC600		0...600V

Analog indicators

Flush mounting analog meters for direct current RQ series



RQ48 - 48x48mm



RQ72 - 72x72mm



RQ96 - 96x96mm

Cat. Nos.			Direct current ammeters by shunt c.d.t. 60mV	
			Direct indication of input current or primary current of external shunt Indication of any quantity, directly proportional to signals coming from transducers or sensors Moving coil equipment Connection by external shunt 1A/60mV...6000A/60mV Connection by transducers or sensors 1...600mA - 0...5/10/20 - 4...20mA Lateral zero or central zero version Live zero or mechanically suppressed (4...20mA) Scale length 90° - Accuracy cl.1,5	
RQ48M	RQ72M	RQ96M	Input	Scale
AN160A1002	AN260A1002	AN360A1002	1A-60mV	0...1A
AN160A1502	AN260A1502	AN360A1502	1.5A-60mV	0...1.5A
AN160A2002	AN260A2002	AN360A2002	2A-60mV	0...2A
AN160A2502	AN260A2502	AN360A2502	2.5A-60mV	0...2.5A
AN160A3002	AN260A3002	AN360A3002	3A-60mV	0...3A
AN160A4002	AN260A4002	AN360A4002	4A-60mV	0...4A
AN160A5002	AN260A5002	AN360A5002	5A-60mV	0...5A
AN160A6002	AN260A6002	AN360A6002	6A-60mV	0...6A
AN160A8002	AN260A8002	AN360A8002	8A-60mV	0...8A
AN160B1002	AN260B1002	AN360B1002	10A-60mV	0...10A
AN160B1502	AN260B1502	AN360B1502	15A-60mV	0...15A
AN160B2002	AN260B2002	AN360B2002	20A-60mV	0...20A
AN160B2502	AN260B2502	AN360B2502	25A-60mV	0...25A
AN160B3002	AN260B3002	AN360B3002	30A-60mV	0...30A
AN160B4002	AN260B4002	AN360B4002	40A-60mV	0...40A
AN160B5002	AN260B5002	AN360B5002	50A-60mV	0...50A
AN160B6002	AN260B6002	AN360B6002	60A-60mV	0...60A
AN160B8002	AN260B8002	AN360B8002	80A-60mV	0...80A
AN160C1002	AN260C1002	AN360C1002	100A-60mV	0...100A
AN160C1202	AN260C1202	AN360C1202	120A-60mV	0...120A
AN160C1502	AN260C1502	AN360C1502	150A-60mV	0...150A
AN160C2002	AN260C2002	AN360C2002	200A-60mV	0...200A
AN160C2502	AN260C2502	AN360C2502	250A-60mV	0...250A
AN160C3002	AN260C3002	AN360C3002	300A-60mV	0...300A
AN160C4002	AN260C4002	AN360C4002	400A-60mV	0...400A
AN160C5002	AN260C5002	AN360C5002	500A-60mV	0...500A
AN160C6002	AN260C6002	AN360C6002	600A-60mV	0...600A
AN160C8002	AN260C8002	AN360C8002	800A-60mV	0...800A
AN160D1002	AN260D1002	AN360D1002	1kA-60mV	0...1000A
AN160D1202	AN260D1202	AN360D1202	1.2kA-60mV	0...1,2kA
AN160D1502	AN260D1502	AN360D1502	1.5kA-60mV	0...1,5kA
AN160D2002	AN260D2002	AN360D2002	2kA-60mV	0...2kA
AN160D2502	AN260D2502	AN360D2502	2.5kA-60mV	0...2,5kA
AN160D3002	AN260D3002	AN360D3002	3kA-60mV	0...3kA
AN160D4002	AN260D4002	AN360D4002	4kA-60mV	0...4kA
AN160D5002	AN260D5002	AN360D5002	5kA-60mV	0...5kA
AN160D6002	AN260D6002	AN360D6002	6kA-60mV	0...6kA
AN16SB6001	AN26SB6001	AN36SB6001	-...0...60mV	Note 1

Other executions available
Input/central zero scale: Replace the 5th number (0) of product code with 1

Cat. Nos.			Direct current ammeters direct connection	
RQ48M	RQ72M	RQ96M	Input	Scale
AN130B5002	AN238B5002	AN338B5002		0...50µA
AN130C1002	AN238C1002	AN338C1002		0...100µA
AN130C1502	AN238C1502	AN338C1502		0...150µA
AN130AC002	AN238C2002	AN338C2002		0...200µA
AN130C2502	AN238C2502	AN338C2502		0...250µA
AN130C4002	AN238C4002	AN338C4002		0...400µA
AN130C5002	AN238C5002	AN338C5002		0...500µA
AN130C6002	AN238C6002	AN338C6002		0...600µA
AN138A1002	AN238A1002	AN338A1002		0...1A
AN138A1502	AN238A1502	AN338A1502	direct	0...1.5A
AN138A2002	AN238A2002	AN338A2002		0...2A
AN138A2502	AN238A2502	AN338A2502		0...2.5A
AN138A3002	AN238A3002	AN338A3002		0...3A
AN138A4002	AN238A4002	AN338A4002		0...4A
AN138A5002	AN238A5002	AN338A5002		0...5A
AN138A6002	AN238A6002	AN338A6002		0...6A
AN138B1002	AN238B1002	AN338B1002		0...10A
AN138B1502	AN238B1502	AN338B1502		0...15A
AN138B2002	AN238B2002	AN338B2002		0...20A
AN138B2502	AN238B2502	AN338B2502		0...25A
AN138B3002	AN238B3002	AN338B3002		0...30A
AN138B4002	AN238B4002	AN338B4002		0...40A
	AN238B5002	AN338B5002		0...50A
	AN238B6002	AN338B6002		0...60A

Other executions available
Input/central zero scale: Replace the 5th number (0) of product code with 1 for µA
Input/central zero scale: Replace the 5th number (8) of product code with 9 for A

Cat. Nos.			Direct current indicators by transducers/sensors	
RQ48M	RQ72M	RQ96M	Input	Scale
AN132A1001	AN232A1001	AN332A1001	0...1mA	Note 2
AN132A5001	AN232A5001	AN332A5001	0...5mA	Note 2
AN132B1001	AN232B1001	AN332B1001	0...10mA	Note 2
AN132B2001	AN232B2001	AN332B2001	0...20mA	Note 2
AN133A1001	AN233A1001	AN333A1001	1...0...1mA	Note 2
AN133A5001	AN233A5001	AN333A5001	5...0...5mA	Note 2
AN133B1001	AN233B1001	AN333B1001	10...0...10mA	Note 2
AN133B2001	AN233B2001	AN333B2001	20...0...20mA	Note 2
AN134M0001	AN234M0001	AN334M0001	4...20mA	Note 2
AN135V0001	AN235V0001	AN335V0001	0...4...20mA	Note 2
AN13SA1001	AN23SA1001	AN33SA1001	-...0...1mA	Note 3

Note 1 In addition to the product code indicate the scale to zero shifted eg 20 ... 0 ... 100A 100A = 60mV

Note 2 In addition to the product code indicate the scale corresponding to the input

Note 3 In addition to the product code indicate the scale moved to zero (ie 20-0-100kW 100kW = 1mA)

Analog indicators

Flush mounting analog meters for direct voltage RQ series



Analog indicators

Flush mounting analog meters for frequency RQ series



Cat. Nos.			Direct voltage voltmeters direct connection	
			Direct indication of input voltage Indication of any quantity, directly proportional to signals coming from transducers, sensors or shunt Moving coil equipment Direct connection 10...600V Connection by shunt 50...500mV Connection by transducers or sensors 5 – 10V Lateral zero or central zero version Scale length 90° - Accuracy cl.1,5	
RQ48M	RQ72M	RQ96M	Input	Scale
AN164B1002	AN264B1002	AN364B1002		0...10V
AN164B1502	AN264B1502	AN364B1502		0...15V
AN164B2502	AN264B2502	AN364B2502		0...25V
AN164B3002	AN264B3002	AN364B3002		0...30V
AN164B4002	AN264B4002	AN364B4002		0...40V
AN164B6002	AN264B6002	AN364B6002		0...60V
AN164B8002	AN264B8002	AN364B8002	direct	0...80V
AN164C1002	AN264C1002	AN364C1002		0...100V
AN164C1502	AN264C1502	AN364C1502		0...150V
AN164C2002	AN264C2002	AN364C2002		0...200V
AN164C2502	AN264C2502	AN364C2502		0...250V
AN164C3002	AN264C3002	AN364C3002		0...300V
AN164C4002	AN264C4002	AN364C4002		0...400V
AN164C5002	AN264C5002	AN364C5002		0...500V
AN164C6002	AN264C6002	AN364C6002		0...600V

Other executions available

Input/Central zero scale: Replace the 5th number (4) of teh product code with 5

Cat. Nos.			Direct voltage indicators by transducers/sensors/shunt	
RQ48M	RQ72M	RQ96M	Input	Scale
AN162B5001	AN262B5001	AN362B5001	0...50mV	
AN162B6001	AN262B6001	AN362B6001	0...60mV	
AN162C1001	AN262C1001	AN362C1001	0...100mV	
AN162C1201	AN262C1201	AN362C1201	0...120mV	
AN162C1251	AN262C1251	AN362C1251	0...125mV	
AN162C1501	AN262C1501	AN362C1501	0...150mV	
AN162C3001	AN262C3001	AN362C3001	0...300mV	
AN163B5001	AN263B5001	AN363B5001	50...0...50mV	Note 1
AN163B6001	AN263B6001	AN363B6001	60...0...60mV	
AN163C1001	AN263C1001	AN363C1001	100...0...100mV	
AN163C1201	AN263C1201	AN363C1201	120...0...120mV	
AN163C1251	AN263C1251	AN363C1251	125...0...125mV	
AN163C1501	AN263C1501	AN363C1501	150...0...150mV	
AN163C3001	AN263C3001	AN363C3001	300...0...300mV	
AN164A5001	AN264A5001	AN364A5001	0...5V	
AN164B1001	AN264B1001	AN364B1001	0...10V	
AN165A5001	AN265A5001	AN365A5001	5...0...5V	
AN165B1001	AN265B1001	AN365B1001	10...0...10V	

Note 1 In addition to the product code indicate the scale corresponding to the input.

Cat. Nos.			Frequency meters direct or by VT	
			Direct indication of input frequency Direct connection Voltage 100...440V Moving coil equipment Scale length 90° Accuracy cl.0,5 (cl.1 45...65Hz)	
RQ48FI	RQ72FI	RQ96FI	Input	Scale
AN1711	AN2711	AN3711	100V	
AN1712	AN2712	AN3712	110-115V	
AN1713	AN2713	AN3713	230-240V	45...55Hz
AN1714	AN2714	AN3714	400-415V	
AN1715	AN2715	AN3715	440V	
AN1721	AN2721	AN3721	100V	
AN1722	AN2722	AN3722	110-115V	
AN1723	AN2723	AN3723	230-240V	45...65Hz
AN1724	AN2724	AN3724	400-415V	
AN1725	AN2725	AN3725	440V	
AN1731	AN2731	AN3731	100V	
AN1732	AN2732	AN3732	110-115V	
AN1733	AN2733	AN3733	230-240V	55...65Hz
AN1734	AN2734	AN3734	400-415V	
AN1735	AN2735	AN3735	440V	

Analog indicators

Flush mounting analog meters for maximum demand ammeters
RQ series



RQ48 - 48x48mm

RQ72 - 72x72mm

RQ96 - 96x96mm

Analog indicators

Flush mounting analog meters for thermal and moving iron
ammeters RQ series



RQ72 - 72x72mm

RQ96 - 96x96mm

Cat. Nos.

Maximum demand ammeters current by CT Delay time 15min

Detection of mean load condition in a plant
Thermal equipment to show the current demand value
Delay time 15 minutes
Current demand indication 0...1,2In
Max. current demand indication (red pointer)
Red pointer with reset knob (sealable)
Scale lenght 90°

RQ48T	RQ72T	RQ96T	Input	Scale
AN1L251A500	AN2L251A500	AN3L251A500	5/5A	0...6A
AN1L251B100	AN2L251B100	AN3L251B100	10/5A	0...12A
AN1L251B150	AN2L251B150	AN3L251B150	15/5A	0...18A
AN1L251B200	AN2L251B200	AN3L251B200	20/5A	0...24A
AN1L251B250	AN2L251B250	AN3L251B250	25/5A	0...30A
AN1L251B300	AN2L251B300	AN3L251B300	30/5A	0...36A
AN1L251B400	AN2L251B400	AN3L251B400	40/5A	0...48A
AN1L251B500	AN2L251B500	AN3L251B500	50/5A	0...60A
AN1L251B600	AN2L251B600	AN3L251B600	60/5A	0...72A
AN1L251B700	AN2L251B700	AN3L251B700	70/5A	0...84A
AN1L251B750	AN2L251B750	AN3L251B750	75/5A	0...90A
AN1L251B800	AN2L251B800	AN3L251B800	80/5A	0...96A
AN1L251C100	AN2L251C100	AN3L251C100	100/5A	0...120A
AN1L251C120	AN2L251C120	AN3L251C120	120/5A	0...144A
AN1L251C125	AN2L251C125	AN3L251C125	125/5A	0...150A
AN1L251C150	AN2L251C150	AN3L251C150	150/5A	0...180A
AN1L251C160	AN2L251C160	AN3L251C160	160/5A	0...192A
AN1L251C200	AN2L251C200	AN3L251C200	200/5A	0...240A
AN1L251C250	AN2L251C250	AN3L251C250	250/5A	0...300A
AN1L251C300	AN2L251C300	AN3L251C300	300/5A	0...360A
AN1L251C400	AN2L251C400	AN3L251C400	400/5A	0...480A
AN1L251C500	AN2L251C500	AN3L251C500	500/5A	0...600A
AN1L251C600	AN2L251C600	AN3L251C600	600/5A	0...720A
AN1L251C700	AN2L251C700	AN3L251C700	700/5A	0...840A
AN1L251C750	AN2L251C750	AN3L251C750	750/5A	0...900A
AN1L251C800	AN2L251C800	AN3L251C800	800/5A	0...960A
AN1L251D100	AN2L251D100	AN3L251D100	1000/5A	0...1.2kA
AN1L251D120	AN2L251D120	AN3L251D120	1200/5A	0...1.44kA
AN1L251D125	AN2L251D125	AN3L251D125	1250/5A	0...1.5kA
AN1L251D150	AN2L251D150	AN3L251D150	1500/5A	0...1.8kA
AN1L251D160	AN2L251D160	AN3L251D160	1600/5A	0...1.92kA
AN1L251D200	AN2L251D200	AN3L251D200	2000/5A	0...2.4kA
AN1L251D250	AN2L251D250	AN3L251D250	2500/5A	0...3kA
AN1L251D300	AN2L251D300	AN3L251D300	3000/5A	0...3.6kA
AN1L251D400	AN2L251D400	AN3L251D400	4000/5A	0...4.8kA
AN1L251D500	AN2L251D500	AN3L251D500	5000/5A	0...6kA
AN1L251D600	AN2L251D600	AN3L251D600	6000/5A	0...7.2kA
AN1L251D800	AN2L251D800	AN3L251D800	8000/5A	0...9.6kA
AN1L251E100	AN2L251E100	AN3L251E100	10000/5A	0...12kA

Cat. Nos.

Thermal and moving iron ammeters by CT Delay time 15min

Detection of mean and instantaneous load condition in a plant
Thermal equipment to show the current demand value
Moving-iron equipment to show the instantaneous Current demand (thermal) indication 0...1,2In
Instantaneous current indication 0...In
Max. current demand indication (red pointer)
Red pointer with reset knob (sealable)
Scale lenght 90°
Thermal current accuracy class 3
Instantaneous current accuracy class 1,5

RQ72TE	RQ96TE	Input	Scale
AN2M251A500	AN3M251A500	5/5A	0...5A/0...6A
AN2M251B100	AN3M251B100	10/5A	0...10A/0...12A
AN2M251B150	AN3M251B150	15/5A	0...15A/0...18A
AN2M251B200	AN3M251B200	20/5A	0...20A/0...24A
AN2M251B250	AN3M251B250	25/5A	0...25A/0...30A
AN2M251B300	AN3M251B300	30/5A	0...30A/0...36A
AN2M251B400	AN3M251B400	40/5A	0...40A/0...48A
AN2M251B500	AN3M251B500	50/5A	0...50A/0...60A
AN2M251B600	AN3M251B600	60/5A	0...60A/0...72A
AN2M251B700	AN3M251B700	70/5A	0...70A/0...84A
AN2M251B750	AN3M251B750	75/5A	0...75A/0...90A
AN2M251B800	AN3M251B800	80/5A	0...80A/0...96A
AN2M251C100	AN3M251C100	100/5A	0...100A/0...120A
AN2M251C120	AN3M251C120	120/5A	0...120A/0...144A
AN2M251C125	AN3M251C125	125/5A	0...125A/0...150A
AN2M251C150	AN3M251C150	150/5A	0...150A/0...180A
AN2M251C160	AN3M251C160	160/5A	0...160A/0...192A
AN2M251C200	AN3M251C200	200/5A	0...200A/0...240A
AN2M251C250	AN3M251C250	250/5A	0...250A/0...300A
AN2M251C300	AN3M251C300	300/5A	0...300A/0...360A
AN2M251C400	AN3M251C400	400/5A	0...400A/0...480A
AN2M251C500	AN3M251C500	500/5A	0...500A/0...600A
AN2M251C600	AN3M251C600	600/5A	0...600A/0...720A
AN2M251C700	AN3M251C700	700/5A	0...700A/0...840A
AN2M251C750	AN3M251C750	750/5A	0...750A/0...900A
AN2M251C800	AN3M251C800	800/5A	0...800A/0...960A
AN2M251D100	AN3M251D100	1000/5A	0...1kA/0...1.2kA
AN2M251D120	AN3M251D120	1200/5A	0...1,2kA/0...1,44kA
AN2M251D125	AN3M251D125	1250/5A	0...1,25kA/0...1,5kA
AN2M251D150	AN3M251D150	1500/5A	0...1,5kA/0...1,8kA
AN2M251D160	AN3M251D160	1600/5A	0...1,6kA/0...1,92kA
AN2M251D200	AN3M251D200	2000/5A	0...2kA/0...2,4kA
AN2M251D250	AN3M251D250	2500/5A	0...2,5kA/0...3kA
AN2M251D300	AN3M251D300	3000/5A	0...3kA/0...3,6kA
AN2M251D400	AN3M251D400	4000/5A	0...4kA/0...4,8kA
AN2M251D500	AN3M251D500	5000/5A	0...5kA/0...6kA
AN2M251D600	AN3M251D600	6000/5A	0...6kA/0...7,2kA
AN2M251D800	AN3M251D800	8000/5A	0...8kA/0...9,6kA
AN2M251E100	AN3M251E100	10000/5A	0...10kA/0...12kA

Other executions available

2In overscale: Replace the 7th number (1) of product code with 2

Analog indicators

Flush mounting analog meters for power meters RQ series



Cat. Nos.			Wattmeters indicator	
RQ48M	RQ72M	RQ96M	Input	Scale
AN132A1001	AN232A1001	AN332A1001	0...1mA	
AN133A1001	AN233A1001	AN333A1001	1...0...1mA	Note 1
AN13SA1001	AN23SA1001	AN33SA1001	-...0...1mA	

Analog power meters to be combined with transducer TESI P series
Single-phase or three-phase, active or reactive power measuring
Direct power reading, primary side
Direct voltage connection up to 440V or by external VT/100V or /110V
Current input by external CT /5A or /1A

Cat. Nos.			Varmeter	
RQ48M	RQ72M	RQ96M	Input	Scale
AN132A1001	AN232A1001	AN332A1001	0...1mA	
AN133A1001	AN233A1001	AN333A1001	1...0...1mA	Note 1
AN13SA1001	AN23SA1001	AN33SA1001	-...0...1mA	

Analog power meters to be combined with transducer TESI Q series

Cat. Nos.		TESI P Active power transducer TESI Q Reactive power transducer				
TESI P	TESI Q	Line	Input A	Input V	Output	Setting
TN2P1PA12A	TN2Q1PA12A	1P	5A	100V	...0...1mA	Note 2
TN2P1PA22A	TN2Q1PA22A			110V		
TN2P1PA32A	TN2Q1PA32A			230V		
TN2P1PA42A	TN2Q1PA42A			240V		
TN2P2PA12A	TN2Q2PA12A	3P balanced	5A	100V	1...0...1mA	Note 2
TN2P2PA22A	TN2Q2PA22A			110V		
TN2P2PA52A	TN2Q2PA52A			400V		
TN2P2PA62A	TN2Q2PA62A			415V		
TN2P2PA72A	TN2Q2PA72A			440V		
TN2P3PA12A	TN2Q3PA12A	3P+N balanced	5A	100V	1...0...1mA	Note 2
TN2P3PA22A	TN2Q3PA22A			110V		
TN2P3PA52A	TN2Q3PA52A			400V		
TN2P3PA62A	TN2Q3PA62A			415V		
TN2P3PA72A	TN2Q3PA72A			440V		
TN2P4PA12A	TN2Q4PA12A	3P unbalanced	5A	100V	1...0...1mA	Note 2
TN2P4PA22A	TN2Q4PA22A			110V		
TN2P4PA52A	TN2Q4PA52A			400V		
TN2P4PA62A	TN2Q4PA62A			415V		
TN2P4PA72A	TN2Q4PA72A			440V		
TN2P5PA12A	TN2Q5PA12A	3P+T unbalanced	5A	100V	1...0...1mA	Note 2
TN2P5PA22A	TN2Q5PA22A			110V		
TN2P5PA52A	TN2Q5PA52A			400V		
TN2P5PA62A	TN2Q5PA62A			415V		
TN2P5PA72A	TN2Q5PA72A			440V		

* Input from CT/1A Replace the 9th number (2) of the product code with 1

Analog indicators

Flush mounting analog meters for power factor meters RQ series



Cat. Nos.			Power Factor	
RQ48M	RQ72M	RQ96M	Input	Scale
AN133A1001	AN233A1001	AN333A1001	1...0...1mA	Note

Analog cosφ meters to be combined with transducer TESI PF series
Single-phase or three-phase 3-4wires, balanced load
Direct voltage connection up to 440V or by external VT/100V or /110V
Current input by external CT /5A or /1A

Note In addition to the product code indicate the start and end of scale values ind 0,5...1...0,5 cap

Cat. Nos.		TESI PF Power Factor transducer					
		Line	Input A*	Input V	Output	Setting	
TN2C11A12A	1P or 3P+N balanced	5A	100V	110V	1...0...1mA	ind 0,5...1...0,5 cap	
TN2C11A22A							230V
TN2C11A32A							240V
TN2C11A42A							
TN2C21A12A	3P balanced	5A	100V	1...0...1mA	ind 0,5...1...0,5 cap		
TN2C21A22A			110V				
TN2C21A52A			400V				
TN2C21A62A			415V				
TN2C21A72A			440V				

* Input from CT/1A Replace the 9th number (2) of the product code with 1

Note 1 In addition to the product code indicate the start and end of scale values in W, kW, MW, var, kvar, Mvar

Note 2 In addition to the product code indicate the CT ratio, the ratio of the TV, if established and the power value corresponding to the output 1mA in W or kW or MW (the value must be between 50% and 120% of rated output Pn - single-phase line Pn = V x I and three-phase line Pn = 3 x I x V where V is the rated voltage or the primary of the TV and I to Nominal value of current or the CT primary.

Analog indicators

Interchangeable scale for RQ series



RQ48 - 48x48mm



RQ72 - 72x72mm



RQ96 - 96x96mm





Cat. Nos.			Interchangeable scale for A.C. ammeters by CT	
RQ48E	RQ72E	RQ96E	Input	Scale
SC12D1A500	SC22D1A500	SC32D1A500	5/5A	0...5A
SC1251B100	SC2251B100	SC3251B100	10/5A	0...10A
SC1251B150	SC2251B150	SC3251B150	15/5A	0...15A
SC1251B200	SC2251B200	SC3251B200	20/5A	0...20A
SC1251B250	SC2251B250	SC3251B250	25/5A	0...25A
SC1251B300	SC2251B300	SC3251B300	30/5A	0...30A
SC1251B400	SC2251B400	SC3251B400	40/5A	0...40A
SC1251B500	SC2251B500	SC3251B500	50/5A	0...50A
SC1251B600	SC2251B600	SC3251B600	60/5A	0...60A
SC1251B700	SC2251B700	SC3251B700	70/5A	0...70A
SC1251B750	SC2251B750	SC3251B750	75/5A	0...75A
SC1251B800	SC2251B800	SC3251B800	80/5A	0...80A
SC1251C100	SC2251C100	SC3251C100	100/5A	0...100A
SC1251C120	SC2251C120	SC3251C120	120/5A	0...120A
SC1251C125	SC2251C125	SC3251C125	125/5A	0...125A
SC1251C150	SC2251C150	SC3251C150	150/5A	0...150A
SC1251C160	SC2251C160	SC3251C160	160/5A	0...160A
SC1251C200	SC2251C200	SC3251C200	200/5A	0...200A
SC1251C250	SC2251C250	SC3251C250	250/5A	0...250A
SC1251C300	SC2251C300	SC3251C300	300/5A	0...300A
SC1251C400	SC2251C400	SC3251C400	400/5A	0...400A
SC1251C500	SC2251C500	SC3251C500	500/5A	0...500A
SC1251C600	SC2251C600	SC3251C600	600/5A	0...600A
SC1251C700	SC2251C700	SC3251C700	700/5A	0...700A
SC1251C750	SC2251C750	SC3251C750	750/5A	0...750A
SC1251C800	SC2251C800	SC3251C800	800/5A	0...800A
SC1251D100	SC2251D100	SC3251D100	1000/5A	0...1000A
SC1251D120	SC2251D120	SC3251D120	1200/5A	0...1200A
SC1251D125	SC2251D125	SC3251D125	1250/5A	0...1250A
SC1251D150	SC2251D150	SC3251D150	1500/5A	0...1500A
SC1251D160	SC2251D160	SC3251D160	1600/5A	0...1600A
SC1251D200	SC2251D200	SC3251D200	2000/5A	0...2000A
SC1251D250	SC2251D250	SC3251D250	2500/5A	0...2500A
SC1251D300	SC2251D300	SC3251D300	3000/5A	0...3000A
SC1251D400	SC2251D400	SC3251D400	4000/5A	0...4000A
SC1251D500	SC2251D500	SC3251D500	5000/5A	0...5000A
SC1251D600	SC2251D600	SC3251D600	6000/5A	0...6000A
SC1251D700	SC2251D700	SC3251D700	7000/5A	0...7000A
SC1251D750	SC2251D750	SC3251D750	7500/5A	0...7500A
SC1251D800	SC2251D800	SC3251D800	8000/5A	0...8000A
SC1251E100	SC2251E100	SC3251E100	10000/5A	0...10000A



Cat. Nos.			Interchangeable scale for direct voltage and current indicators connection through transducers/sensors/shunt	
RQ48E	RQ72E	RQ96E	Input	Scale
SC130L0000	SC230L0000	SC330L0000	various in dc	Note 1
SC134M0000	SC234M0000	SC334M0000	4...20mA	
SC135V0000	SC235V0000	SC335V0000	0...4...20mA	

Note 1 In addition to the product code indicate the scale corresponding to the input

Analog indicators

Flush mounting analog meters AQ series

MODEL	AQ48MRAD -AQ72MRAD - AQ96MRAD		AQ48M - AQ72M - AQ96M	
 AQ48 - 48x48mm AQ72 - 72x72mm AQ96 - 96x96mm	 		 	
Type	Ammeters	Voltmeters	Ammeters	Voltmeters
Technical notes	NT790	NT791	NT794	NT795
DISPLAY				
Scale	interchangeable			
Scale length	240°			
Standard scale marking	0...In	0...Un	In...0...In	Un...0...Un
Motor startup marking scale	0...In...2In or 0...In...5In		-	-
INPUT				
Connection	direct or by CT /5A or /1A	direct or by Vt	direct or by external shunt	
Measure	average value measurement, related to r.m.s value, form factor 1,11			
Rating current In (direct)	1...5A	-	2...5A	-
Rating current In (CT or shunt connection)	5A or 1A	-	1A/60mV... 6000A/60mV	-
Rating current In (transducers/sensors)	-	-	1...600mA – 0...5/10/20mA – 4...20mA	-
Rating voltage Un (direct)	-	10...600V	-	10...600V
Rating voltage Un (VT or shunt connection)	-	VT/100V - VT/110V	-	50...500mV
Rating voltage Un (transducers/sensors)	-	-	-	5 – 10V
Continuous overload	1,2In	1,2Un	1,2In	1,2Un
Instantaneous overload	10In/5s	10Un/5s	10In/5s	10Un/5s
Rating frequency fn	50Hz (400Hz in option)			
Working frequency	45...65Hz			
Accuracy (EN/IEC 60051)	class 1,5		class 1	class 1.5
Voltage drop	-		60mV (10mA...5A)	-
Rated burden	≤ 1,1VA	≤ 1mA	-	10mA with Un 60...300mV 1mA (1kΩ/V) with Un 0,5...600V
NOMINAL RANGE				
Voltage	-			
Current	-			
Power factor	-			
Waveform	-			
MEASURING RANGE				
Active power	-			
Reactive power	-			
Power of calibration Pc (Qc)	-			
Cosφ	-			
INSULATION (EN/IEC 61010-1)				
Installation category	III			
Pollution degree	2			
Insulation voltage rating	600V (Phase - Neutral)			
Impulse voltage test (current input towards voltage input and output)	-			
A.C. voltage test (current input towards voltage input and output)	-			
A.C. voltage test (all circuits and earth)	4kV r.m.s. 50Hz/5s			
ENVIRONMENTAL CONDITIONS				
Nominal temperature range	5...40°C			
Limit range for storage and transport	-40...80°C			
Max. power dissipation	-			
Vibration test according to	EN/IEC 60051-1			
Shock test according to	EN/IEC 60051-1			
MECHANICAL FEATURES				
Mounting	flush mounting			
Housing material	self-extinguishing polycarbonate			
Connections	screw terminal / fast-on 6,3 x 0,8mm			
Protection degree (EN/IEC 60529)	IP52 front frame (IP54 in option), IP20 terminals (with protection)			
Weight	250gr (AQ48)-300gr (AQ72)-350gr (AQ96)		140gr (AQ48) - 550gr (AQ72) - 600gr (AQ96)	

AQ72FI - AQ96FI	AQ48M	AQ48M
		
Frequency meters NT808	Power meters NT701	Cosφ meters NT705
	-	
	240°	
45...55Hz - 55...65Hz - 45...65Hz	upon request	
	-	
direct	direct connection or by VT/CT	
frequency	thermal current	-
	1 - 5A	
	-	
	-	
-	100-110-230-240-400-415-440V (ph-ph)	
	-	
-	In - Un	-
-	2In/5s - 2Un/5s	In and 2Un/5s - Un and 2In/0,5s
-	50Hz (400Hz in option)	
-	45...65Hz	47...63Hz
class 0,5 - class 1 (45...65Hz)	class 1,5	
≤ 4VA	voltage ≤ 1VA - current ≤ 0,5VA	
-	85...115%Un (max. 450V)	
-	0...120%In	
-	cosφ 0,5 inductive	-
-	senf 0,5 inductive	-
-	sinusoidal, distortion factor < 20%	
-	-Ph...0...Ph	-
-	-Qn...0...Qn	-
-	0,6...1,2Pn (Qn)	-
-	-	0,5 inductive 1...0,5 capacitive
	III	
	2	
600V (Phase - Neutral)	300V (Phase - Neutral)	
-	5kV 1,2/50μs 0,5J	
-	2,5kV r.m.s. 50Hz/1min	
	4kV r.m.s. 50Hz/1min	
5...40°C	0...40°C	
-40...80°C	-10...55°C	
-	≤ 3,6W	
EN/IEC 60051-1	EN62052-11	
EN/IEC 60051-1	EN62052-11	
	flush mounting	
	self-extinguishing polycarbonate	
	screw terminal / fast-on 6,3 x 0,8mm	
	IP52 front frame (IP54 in option), IP20 terminals (with protection)	
240gr (AQ72) - 320gr (AQ96)	140gr (AQ48) - 240gr (AQ72) - 320gr (AQ96)	

Wiring diagrams

Ammeter

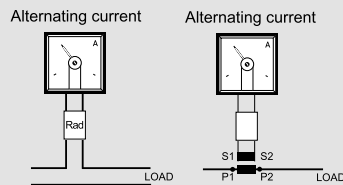
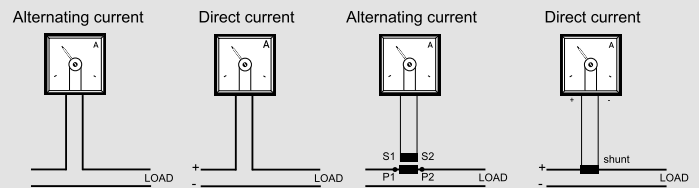

Voltmeter

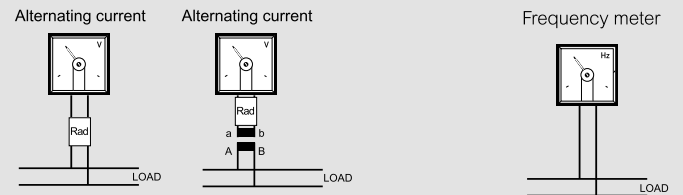
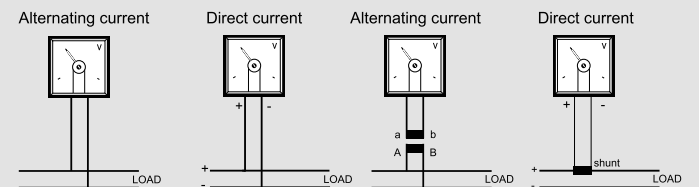

Power meter

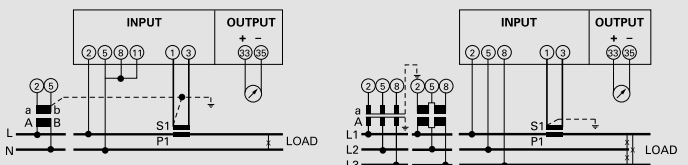

Cosφ meter

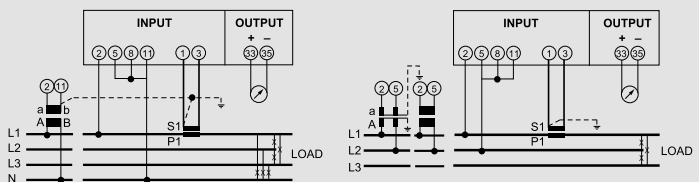

Dimensions

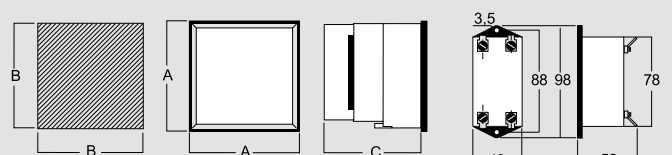

Dim. (mm)	A	B	C
AQ48...	48x48	45x45	85.5
AQ72...	72x72	68x68	84
AQ96...	96x96	92x92	84

Rectifier accessory for AQ48M/rad

Analog indicators

Flush mounting analog meters for alternating current AQ series with rectifier accessory



AQ48 - 48x48mm



AQ72 - 72x72mm



AQ96 - 96x96mm

Cat. Nos.

Alternating current ammeters by CT

Direct indication of input current or primary current of external CT
 Moving coil equipment, with rectifier accessory
 Input by external CT /5A or /1A
 Version for starting motor 2In or 5In
 Scale length 240°
 Accuracy class 1,5

AQ48Mrad	AQ72Mrad	AQ96Mrad	Input	Scale
AN51510000	AN61510000	AN71510000	-/5A	*
AN51D1A500	AN61D1A500	AN71D1A500	5/5A	0...5A
AN5151B100	AN6151B100	AN7151B100	10/5A	0...10A
AN5151B150	AN6151B150	AN7151B150	15/5A	0...15A
AN5151B200	AN6151B200	AN7151B200	20/5A	0...20A
AN5151B250	AN6151B250	AN7151B250	25/5A	0...25A
AN5151B300	AN6151B300	AN7151B300	30/5A	0...30A
AN5151B400	AN6151B400	AN7151B400	40/5A	0...40A
AN5151B500	AN6151B500	AN7151B500	50/5A	0...50A
AN5151B600	AN6151B600	AN7151B600	60/5A	0...60A
AN5151B700	AN6151B700	AN7151B700	70/5A	0...70A
AN5151B750	AN6151B750	AN7151B750	75/5A	0...75A
AN5151B800	AN6151B800	AN7151B800	80/5A	0...80A
AN5151C100	AN6151C100	AN7151C100	100/5A	0...100A
AN5151C120	AN6151C120	AN7151C120	120/5A	0...120A
AN5151C125	AN6151C125	AN7151C125	125/5A	0...125A
AN5151C150	AN6151C150	AN7151C150	150/5A	0...150A
AN5151C160	AN6151C160	AN7151C160	160/5A	0...160A
AN5151C200	AN6151C200	AN7151C200	200/5A	0...200A
AN5151C250	AN6151C250	AN7151C250	250/5A	0...250A
AN5151C300	AN6151C300	AN7151C300	300/5A	0...300A
AN5151C400	AN6151C400	AN7151C400	400/5A	0...400A
AN5151C500	AN6151C500	AN7151C500	500/5A	0...500A
AN5151C600	AN6151C600	AN7151C600	600/5A	0...600A
AN5151C700	AN6151C700	AN7151C700	700/5A	0...700A
AN5151C750	AN6151C750	AN7151C750	750/5A	0...750A
AN5151C800	AN6151C800	AN7151C800	800/5A	0...800A
AN5151D100	AN6151D100	AN7151D100	1000/5A	0...1000A
AN5151D120	AN6151D120	AN7151D120	1200/5A	0...1,2kA
AN5151D125	AN6151D125	AN7151D125	1250/5A	0...1,25kA
AN5151D150	AN6151D150	AN7151D150	1500/5A	0...1,5kA
AN5151D160	AN6151D160	AN7151D160	1600/5A	0...1,6kA
AN5151D200	AN6151D200	AN7151D200	2000/5A	0...2kA
AN5151D250	AN6151D250	AN7151D250	2500/5A	0...2,5kA
AN5151D300	AN6151D300	AN7151D300	3000/5A	0...3kA
AN5151D400	AN6151D400	AN7151D400	4000/5A	0...4kA
AN5151D500	AN6151D500	AN7151D500	5000/5A	0...5kA
AN5151D600	AN6151D600	AN7151D600	6000/5A	0...6kA
AN5151D800	AN6151D800	AN7151D800	8000/5A	0...8kA
AN5151E100	AN6151E100	AN7151E100	10000/5A	0...10kA

Other executions available

2In overscale: Replace the 6th number (1) of product code with 2

5In overscale: Replace the 6th number (1) of product code with 5

Input from CT/1A: Replace the 5th number (5 or D) of the product code with 1

Cat. Nos.

Alternating current ammeters direct connection

Moving coil equipment, with rectifier

AQ48Mrad	AQ72Mrad	AQ96Mrad	Input	Scale
AN51D1A100	AN61D1A100	AN71D1A100		0...1A
AN51D1A250	AN61D1A250	AN71D1A250	direct	0...2.5A
AN51D1A500	AN61D1A500	AN71D1A500		0...5A

Other executions available

2In overscale: Replace the 6th number (1) of product code with 2

5In overscale: Replace the 6th number (1) of product code with 5

Analog indicators

Flush mounting analog meters for alternating voltage AQ series



AQ48 - 48x48mm



AQ72 - 72x72mm



AQ96 - 96x96mm

Cat. Nos.			Alternating voltage voltmeters by VT	
			Direct indication of input voltage or primary voltage of external VT Moving coil equipment with rectifier accessory Input by external VT /100V - /110V Scale length 240° Accuracy class 1,5	
AQ48Mrad	AQ72Mrad	AQ96Mrad	Input	Scale
AN54111111	AN64111111	AN74111111	0...100V	note1
AN54211111	AN64211111	AN74211111	0...120V	note1
AN54311111	AN64311111	AN74311111	0...125V	note1
AN54411111	AN64411111	AN74411111	0...131.58V	note1
AN54511111	AN64511111	AN74511111	0...133.33V	note1
AN54611111	AN64611111	AN74611111	0...136.36V	note1
AN54711111	AN64711111	AN74711111	0...150V	note1
AN54P11111	AN64P11111	AN74P11111	other values	note 2

Note 1 - in addition to the Cat. Nos. indicate the scale and the VT ratio. The ladder should correspond to the product of the input value selected and the TV report

Note 2 - in addition to the product code indicate the scale and the VT ratio

Cat. Nos.			Alternating voltage voltmeters direct connection	
			Moving coil equipment, with rectifier	
AQ48Mrad	AQ72Mrad	AQ96Mrad	Input	Scale
AN54DDB100	AN64DDB100	AN74DDB100		0...10V
AN54DDB150	AN64DDB150	AN74DDB150		0...15V
AN54DDB250	AN64DDB250	AN74DDB250		0...25V
AN54DDB300	AN64DDB300	AN74DDB300		0...30V
AN54DDB400	AN64DDB400	AN74DDB400		0...40V
AN54DDB600	AN64DDB600	AN74DDB600		0...60V
AN54DDC100	AN64DDC100	AN74DDC100	direct	0...100V
AN54DDC150	AN64DDC150	AN74DDC150		0...150V
AN54DDC200	AN64DDC200	AN74DDC200		0...200V
AN54DDC250	AN64DDC250	AN74DDC250		0...250V
AN54DDC300	AN64DDC300	AN74DDC300		0...300V
AN54DDC400	AN64DDC400	AN74DDC400		0...400V
AN54DDC500	AN64DDC500	AN74DDC500		0...500V
AN54DDC600	AN64DDC600	AN74DDC600		0...600V

Analog indicators

Flush mounting analog meters for direct current AQ series



AQ48 - 48x48mm

AQ72 - 72x72mm

AQ96 - 96x96mm

AQ48 - 48x48mm

AQ72 - 72x72mm

AQ96 - 96x96mm

Cat. Nos.

Direct current ammeters by shunt c.d.t. 60mV

Direct indication of input current or primary current of external shunt
 Indication of any quantity, directly proportional to signals coming from transducers or sensors
 Moving coil equipment
 Connection by external shunt 1A/60mV...6000A/60mV
 Connection by transducers or sensors 1...600mA - 0...5/10/20 - 4...20mA
 Lateral zero or central zero version
 Live zero or mechanically suppressed (4...20mA)
 Scale length 240° - Accuracy cl.1,5

AQ48M	AQ72M	AQ96M	Input	Scale
AN560A1002	AN660A1002	AN760A1002	1A-60mV	0...1A
AN560A1502	AN660A1502	AN760A1502	1.5A-60mV	0...1.5A
AN560A2002	AN660A2002	AN760A2002	2A-60mV	0...2A
AN560A2502	AN660A2502	AN760A2502	2.5A-60mV	0...2.5A
AN560A3002	AN660A3002	AN760A3002	3A-60mV	0...3A
AN560A4002	AN660A4002	AN760A4002	4A-60mV	0...4A
AN560A5002	AN660A5002	AN760A5002	5A-60mV	0...5A
AN560A6002	AN660A6002	AN760A6002	6A-60mV	0...6A
AN560A8002	AN660A8002	AN760A8002	8A-60mV	0...8A
AN560B1002	AN660B1002	AN760B1002	10A-60mV	0...10A
AN560B1502	AN660B1502	AN760B1502	15A-60mV	0...15A
AN560B2002	AN660B2002	AN760B2002	20A-60mV	0...20A
AN560B2502	AN660B2502	AN760B2502	25A-60mV	0...25A
AN560B3002	AN660B3002	AN760B3002	30A-60mV	0...30A
AN560B4002	AN660B4002	AN760B4002	40A-60mV	0...40A
AN560B5002	AN660B5002	AN760B5002	50A-60mV	0...50A
AN560B6002	AN660B6002	AN760B6002	60A-60mV	0...60A
AN560B8002	AN660B8002	AN760B8002	80A-60mV	0...80A
AN560C1002	AN660C1002	AN760C1002	100A-60mV	0...100A
AN560C1202	AN660C1202	AN760C1202	120A-60mV	0...120A
AN560C1502	AN660C1502	AN760C1502	150A-60mV	0...150A
AN560C2002	AN660C2002	AN760C2002	200A-60mV	0...200A
AN560C2502	AN660C2502	AN760C2502	250A-60mV	0...250A
AN560C3002	AN660C3002	AN760C3002	300A-60mV	0...300A
AN560C4002	AN660C4002	AN760C4002	400A-60mV	0...400A
AN560C5002	AN660C5002	AN760C5002	500A-60mV	0...500A
AN560C6002	AN660C6002	AN760C6002	600A-60mV	0...600A
AN560C8002	AN660C8002	AN760C8002	800A-60mV	0...800A
AN560D1002	AN660D1002	AN760D1002	1kA-60mV	0...1000A
AN560D1202	AN660D1202	AN760D1202	1.2kA-60mV	0...1,2kA
AN560D1502	AN660D1502	AN760D1502	1.5kA-60mV	0...1,5kA
AN560D2002	AN660D2002	AN760D2002	2kA-60mV	0...2kA
AN560D2502	AN660D2502	AN760D2502	2.5kA-60mV	0...2,5kA
AN560D3002	AN660D3002	AN760D3002	3kA-60mV	0...3kA
AN560D4002	AN660D4002	AN760D4002	4kA-60mV	0...4kA
AN560D5002	AN660D5002	AN760D5002	5kA-60mV	0...5kA
AN560D6002	AN660D6002	AN760D6002	6kA-60mV	0...6kA
AN56SB6001	AN66SB6001	AN76SB6001	-...0...60mV	Note1

Cat. Nos.

Direct current ammeters direct connection

AQ48M	AQ72M	AQ96M	Input	Scale
AN538A2002	AN638A2002	AN738A2002	direct	0...2A
AN538A2502	AN638A2502	AN738A2502		0...2.5A
AN539A5002	AN639A5002	AN739A5002		0...5A
AN539A2002	AN639A2002	AN739A2002		2...0...2A
AN539A2502	AN639A2502	AN739A2502		2.5...0...2.5A
AN539A5002	AN639A5002	AN739A5002		5...0...5A

Cat. Nos.

Direct current indicators by transducers/sensors

AQ48M	AQ72M	AQ96M	Input	Scale
AN532A1001	AN632A1001	AN732A1001	0...1mA	Note 2
AN532A5001	AN632A5001	AN732A5001	0...5mA	Note 2
AN532B1001	AN632B1001	AN732B1001	0...10mA	Note 2
AN532B2001	AN632B2001	AN732B2001	0...20mA	Note 2
AN533A1001	AN633A1001	AN733A1001	1...0...1mA	Note 2
AN533A5001	AN633A5001	AN733A5001	5...0...5mA	Note 2
AN533B1001	AN633B1001	AN733B1001	10...0...10mA	Note 2
AN533B2001	AN633B2001	AN733B2001	20...0...20mA	Note 2
AN534M0001	AN634M0001	AN734M0001	4...20mA	Note 2
AN535V0001	AN635V0001	AN735V0001	0...4...20mA	Note 2
AN53SA1001	AN63SA1001	AN73SA1001	-...0...1mA	Note 3

Note 1 In addition to the product code indicate the scale to zero shifted eg 20 ... 0 ... 100A 100A = 60mV

Note 2 In addition to the product code indicate the scale corresponding to the input

Note 3 In addition to the product code indicate the scale moved to zero (ie 20-0-100kW 100kW = 1mA)

Other executions available

Input/central zero scale Replace the 5th number (0) of the product code with 1

Analog indicators

Flush mounting analog meters for direct voltage AQ series



AQ48 - 48x48mm



AQ72 - 72x72mm



AQ96 - 96x96mm

Analog indicators

Flush mounting analog meters for frequency AQ series



AQ72 - 72x72mm



AQ96 - 96x96mm

Cat. Nos.			Direct voltage voltmeters direct connection	
			Direct indication of input voltage Indication of any quantity, directly proportional to signals coming from transducers, sensors or shunt Moving coil equipment Direct connection 10...600V Connection by shunt 50...500mV Connection by transducers or sensors 5 – 10V Lateral zero or central zero version Scale length 240° - Accuracy cl.1,5	
AQ48M	AQ72M	AQ96M	Input	Scale
AN564B1002	AN664B1002	AN764B1002		0...10V
AN564B1502	AN664B1502	AN764B1502		0...15V
AN564B2502	AN664B2502	AN764B2502		0...25V
AN564B3002	AN664B3002	AN764B3002		0...30V
AN564B4002	AN664B4002	AN764B4002		0...40V
AN564B6002	AN664B6002	AN764B6002		0...60V
AN564B8002	AN664B8002	AN764B8002		0...80V
AN564C1002	AN664C1002	AN764C1002	direct	0...100V
AN564C1502	AN664C1502	AN764C1502		0...150V
AN564C2002	AN664C2002	AN764C2002		0...200V
AN564C2502	AN664C2502	AN764C2502		0...250V
AN564C3002	AN664C3002	AN764C3002		0...300V
AN564C4002	AN664C4002	AN764C4002		0...400V
AN564C5002	AN664C5002	AN764C5002		0...500V
AN564C6002	AN664C6002	AN764C6002		0...600V

Other executions available

Input/central zero scale Replace the 5th number (4) of the product code with 5

Cat. Nos.			Direct voltage indicators by transducers/sensors/shunt	
AQ48M	AQ72M	AQ96M	Input	Scale
AN562B5001	AN662B5001	AN762B5001	0...50mV	
AN562B6001	AN662B6001	AN762B6001	0...60mV	
AN562C1001	AN662C1001	AN762C1001	0...100mV	
AN562C1201	AN662C1201	AN762C1201	0...120mV	
AN562C1251	AN662C1251	AN762C1251	0...125mV	
AN562C1501	AN662C1501	AN762C1501	0...150mV	
AN563B5001	AN663B5001	AN763B5001	50...0...50mV	
AN563B6001	AN663B6001	AN763B6001	60...0...60mV	Note 1
AN563C1001	AN663C1001	AN763C1001	100...0...100mV	
AN563C1201	AN663C1201	AN763C1201	120...0...120mV	
AN563C1501	AN663C1501	AN763C1501	150...0...150mV	
AN564A5001	AN664A5001	AN764A5001	0...5V	
AN564B1001	AN664B1001	AN764B1001	0...10V	
AN565A5001	AN665A5001	AN765A5001	5...0...5V	
AN565B1001	AN665B1001	AN765B1001	10...0...10V	

Note 1 In addition to the product code indicate the scale corresponding to the input.

Cat. Nos.		Frequency meters direct or by VT	
		Direct indication of input frequency Direct connection Voltage 100...440V Moving coil equipment Scale length 240° Accuracy cl.0,5 (cl.1 45...65Hz)	
AQ72FI	AQ96FI	Input	Scale
AN6711	AN7711	100V	
AN6712	AN7712	110-115V	
AN6713	AN7713	230-240V	45...55Hz
AN6714	AN7714	400-415V	
AN6715	AN7715	440V	
AN6721	AN7721	100V	
AN6722	AN7722	110-115V	
AN6723	AN7723	230-240V	45...65Hz
AN6724	AN7724	400-415V	
AN6725	AN7725	440V	
AN6731	AN7731	100V	
AN6732	AN7732	110-115V	
AN6733	AN7733	230-240V	55...65Hz
AN6734	AN7734	400-415V	
AN6735	AN7735	440V	

Analog indicators

Flush mounting analog meters for power meters AQ series



Analog indicators

Flush mounting analog meters for power factor meters AQ series



Cat. Nos.			Wattmeters	
			Analog power meters to be combined with transducer TESI P series	
AQ48M	AQ72M	AQ96M	Input	Scale
AN532A1001	AN632A1001	AN732A1001	0...1mA	
AN533A1001	AN633A1001	AN733A1001	1...0...1mA	note1
AN53SA1001	AN63SA1001	AN73SA1001	-...0...1mA	

Cat. Nos.			Power Factor indicators	
			Analog cosφ meters to be combined with transducer TESI PF series	
			Single-phase or three-phase 3-4wires, balanced load	
			Direct voltage connection up to 440V or by external VT/100V or /110V	
			Current input by external CT /5A or /1A	
AQ48M	AQ72M	AQ96M	Input	Scale
AN533A1001	AN633A1001	AN733A1001	0...1mA	note

Cat. Nos.			Varmeter	
			Analog power meters to be combined with transducer TESI Q series	
AQ48M	AQ72M	AQ96M	Input	Scale
AN532A1001	AN632A1001	AN732A1001	0...1mA	
AN533A1001	AN633A1001	AN733A1001	1...0...1mA	note1
AN53SA1001	AN63SA1001	AN73SA1001	-...0...1mA	

Note: In addition to the product code indicate the start and end of scale values ind 0,5...1...0,5 cap

Cat. Nos.		TESI P Active power transducer TESI Q Reactive power transducer				
TESI P	TESI Q	Line	Input A*	Input V	Output	Setting
TN2P1PA12A	TN2Q1PA12A	1P	5A	100V	...0...1mA	Note 2
TN2P1PA22A	TN2Q1PA22A			110V		
TN2P1PA32A	TN2Q1PA32A			230V		
TN2P1PA42A	TN2Q1PA42A			240V		
TN2P2PA12A	TN2Q2PA12A	3P balanced	5A	100V	1...0...1mA	Note 2
TN2P2PA22A	TN2Q2PA22A			110V		
TN2P2PA52A	TN2Q2PA52A			400V		
TN2P2PA62A	TN2Q2PA62A			415V		
TN2P2PA72A	TN2Q2PA72A	440V				
TN2P3PA12A	TN2Q3PA12A	3P+N balanced	5A	100V	1...0...1mA	Note 2
TN2P3PA22A	TN2Q3PA22A			110V		
TN2P3PA52A	TN2Q3PA52A			400V		
TN2P3PA62A	TN2Q3PA62A			415V		
TN2P3PA72A	TN2Q3PA72A	440V				
TN2P4PA12A	TN2Q4PA12A	3P unbalanced	5A	100V	1...0...1mA	Note 2
TN2P4PA22A	TN2Q4PA22A			110V		
TN2P4PA52A	TN2Q4PA52A			400V		
TN2P4PA62A	TN2Q4PA62A			415V		
TN2P4PA72A	TN2Q4PA72A	440V				
TN2P5PA12A	TN2Q5PA12A	3P+T unbalanced	5A	100V	1...0...1mA	Note 2
TN2P5PA22A	TN2Q5PA22A			110V		
TN2P5PA52A	TN2Q5PA52A			400V		
TN2P5PA62A	TN2Q5PA62A			415V		
TN2P5PA72A	TN2Q5PA72A	440V				

Cat. Nos.		TESI PF Power Factor transducer				
Line	Input A*	Input V	Output	Setting		
1P or 3P+N balanced	5A	100V	1...0...1mA	ind	0,5...1...0,5 cap	
		110V				
		230V				
		240V				
3P balanced	5A	100V	1...0...1mA	ind	0,5...1...0,5 cap	
		110V				
		400V				
		415V				
TN2C21A72A	440V					

* Input from CT/1A Replace the 9th number (2) of the product code with 1

* Input from CT/1A Replace the 9th number (2) of the product code with 1

Note 1 In addition to the product code indicate the start and end of scale values in W, kW, MW, var, kvar, Mvar

Note 2 In addition to the product code indicate the CT ratio, the ratio of the TV, if established and the power value corresponding to the output 1mA in W or kW or MW (the value must be between 50% and 120% of rated output Pn - single-phase line Pn = V x I and three-phase line Pn = 3 x I x V where V is the rated voltage or the primary of the TV and I to Nominal value of current or the CT primary.

Analog indicators

Interchangeable scale for AQ series

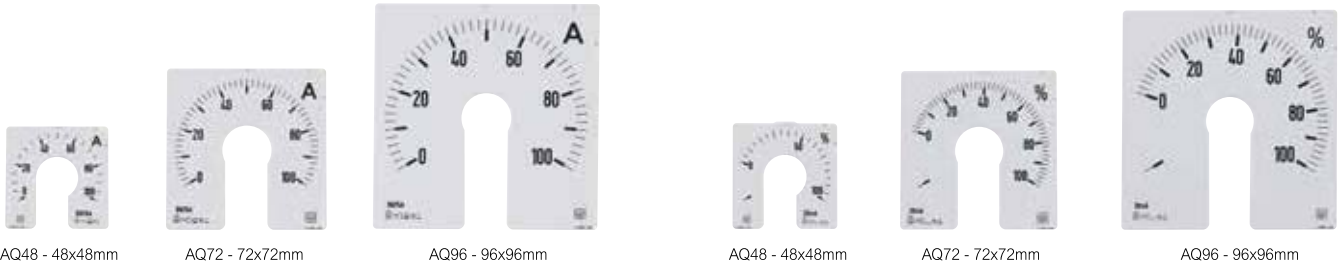

Cat. Nos.			Interchangeable scale for A.C. ammeters by CT	
AQ48Mrad	AQ72Mrad	AQ96Mrad	Input	Scale
SC51D1A500	SC71D1A500	SC71D1A500	5/5A	0...5A
SC5151B100	SC6151B100	SC7151B100	10/5A	0...10A
SC5151B150	SC6151B150	SC7151B150	15/5A	0...15A
SC5151B200	SC6151B200	SC7151B200	20/5A	0...20A
SC5151B250	SC6151B250	SC7151B250	25/5A	0...25A
SC5151B300	SC6151B300	SC7151B300	30/5A	0...30A
SC5151B400	SC6151B400	SC7151B400	40/5A	0...40A
SC5151B500	SC6151B500	SC7151B500	50/5A	0...50A
SC5151B600	SC6151B600	SC7151B600	60/5A	0...60A
SC5151B700	SC6151B700	SC7151B700	70/5A	0...70A
SC5151B750	SC6151B750	SC7151B750	75/5A	0...75A
SC5151B800	SC6151B800	SC7151B800	80/5A	0...80A
SC5151C100	SC6151C100	SC7151C100	100/5A	0...100A
SC5151C120	SC6151C120	SC7151C120	120/5A	0...120A
SC5151C125	SC6151C125	SC7151C125	125/5A	0...125A
SC5151C150	SC6151C150	SC7151C150	150/5A	0...150A
SC5151C160	SC6151C160	SC7151C160	160/5A	0...160A
SC5151C200	SC6151C200	SC7151C200	200/5A	0...200A
SC5151C250	SC6151C250	SC7151C250	250/5A	0...250A
SC5151C300	SC6151C300	SC7151C300	300/5A	0...300A
SC5151C400	SC6151C400	SC7151C400	400/5A	0...400A
SC5151C500	SC6151C500	SC7151C500	500/5A	0...500A
SC5151C600	SC6151C600	SC7151C600	600/5A	0...600A
SC5151C700	SC6151C700	SC7151C700	700/5A	0...700A
SC5151C750	SC6151C750	SC7151C750	750/5A	0...750A
SC5151C800	SC6151C800	SC7151C800	800/5A	0...800A
SC5151D100	SC6151D100	SC7151D100	1000/5A	0...1000A
SC5151D120	SC6151D120	SC7151D120	1200/5A	0...1200A
SC5151D125	SC6151D125	SC7151D125	1250/5A	0...1250A
SC5151D150	SC6151D150	SC7151D150	1500/5A	0...1500A
SC5151D160	SC6151D160	SC7151D160	1600/5A	0...1600A
SC5151D200	SC6151D200	SC7151D200	2000/5A	0...2000A
SC5151D250	SC6151D250	SC7151D250	2500/5A	0...2500A
SC5151D300	SC6151D300	SC7151D300	3000/5A	0...3000A
SC5151D400	SC6151D400	SC7151D400	4000/5A	0...4000A
SC5151D500	SC6151D500	SC7151D500	5000/5A	0...5000A
SC5151D600	SC6151D600	SC7151D600	6000/5A	0...6000A
SC5151D700	SC6151D700	SC7151D700	7000/5A	0...7000A
SC5151D750	SC6151D750	SC7151D750	7500/5A	0...7500A
SC5151D800	SC6151D800	SC7151D800	8000/5A	0...8000A
SC5151E100	SC6151E100	SC7151E100	10000/5A	0...10000A

Cat. Nos.			Interchangeable scale for direct voltage and current indicators connection through transducers/sensors/shunt	
AQ48M	AQ72M	AQ96M	Input	Scale
SC530L0000	SC630L0000	SC730L0000	various in dc	Note 1
SC534M0000	SC634M0000	SC734M0000	4...20mA	
SC535V0000	SC635V0000	SC735V0000	0...4...20mA	

Note 1 In addition to the product code indicate the scale corresponding to the input

Other executions available

2In overscale: Replace the 6th number (1) of product code with 2

5In overscale: Replace the 6th number (1) of product code with 5

Input from CT/1A: Replace the 5th number (5 or D) of the product code with 1

Analog indicators

Modular analog meters D4 series

	ALTERNATING CURRENT (AC)		DIRECT CURRENT (DC)	
Type	Ammeters	Voltmeters	Ammeters	Voltmeters
Technical notes	NT771	NT772	NT774	NT775
DISPLAY				
Scale	interchangeable			
Scale length	90°			
Standard scale marking	0...I _n	0...U _n	-I _n ...0...I _n	-U _n ...0...U _n
Motor startup marking scale	0...I _n ...2I _n or 0...I _n ...5I _n	-	-	-
INPUT				
Connection	direct or by external CT	direct or by external VT	direct or by external shunt	
Measure	true RMS value			
Rating current I _n (direct)	1...60A	-	1mA...40A	-
Rating current I _n (shunt connection)	5A or 1A	-	1A/60mV 1000A/60mV	-
Rating current I _n (transducers/sensors)	-	-	1...600mA 0...5/10/20mA 4...20mA	-
Rating voltage U _n (direct)	-	10...600V	-	50mV... 600V
Rating voltage U _n (shunt connection)	-	VT/100V - VT/110V	-	-
Rating voltage U _n (transducers/sensors)	-	-	-	5 – 10V
Continuous overload	1,2I _n	1,2U _n	1,2I _n	1,2U _n
Instantaneous overload	10I _n /5s	10U _n /5s	10I _n /5s	10U _n /5s
Voltage drop (I _n =10mA...40A)	-	-	≤ 60mV	-
Rating frequency f _n	50Hz (400Hz in option)		-	-
Working frequency	45..65Hz		-	-
Accuracy (EN/IEC 60051)	class 1,5	class 1	class 1,5	
Rated burden	≤ 1,1VA	≤ 3,5VA (500V) - ≤ 3VA (300V)	-	10mA with U _n 60...300mV 1mA (1kΩ/V) with U _n 0,5...600V
INSULATION (EN/IEC 61010-1)				
Installation category	III			
Pollution degree	2			
Insulation voltage rating	600V (Phase - Neutral)			
A.C. voltage test (all circuits and earth)	4kV r.m.s. 50Hz/5s			
ENVIRONMENTAL CONDITIONS				
Nominal temperature range	5...40°C			
Limit range for storage and transport	-40...80°C			
Vibration and shock test according to	EN/IEC 60051-1			
MECHANICAL FEATURES				
Housing	4 module DIN 43880 (35mm)			
Housing material	self-extinguishing polycarbonate			
Connections	screw terminal (cable 4÷10mm ²)			
Protection degree	IP50 front frame, IP20 terminals			
Weight	130 grams		130 grams	150 grams

Wiring diagrams

Ammeter

AC measuring

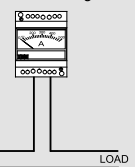

DC measuring

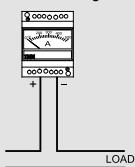

AC measuring

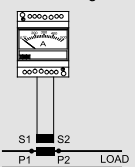

DC measuring

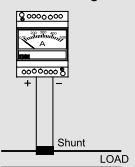

Voltmeter

AC measuring

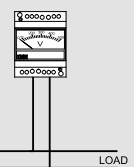

DC measuring

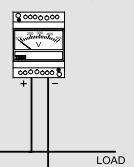

AC measuring

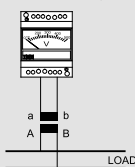

Dimensions

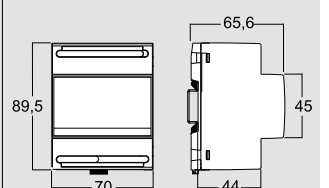

Analog indicators

Modular analog meters for alternating current and voltage D4E series



Cat. Nos.	Alternating current ammeters by CT	
	Direct indication of input current or primary current of external CT Moving iron equipment Input by external CT /5A or /1A Version for starting motor 2In Scale length 90° Accuracy class 1,5	
	Input	Scale
AN92510000	-/5A	*
AN92D1A500	5/5A	0...5A
AN9251B100	10/5A	0...10A
AN9251B150	15/5A	0...15A
AN9251B200	20/5A	0...20A
AN9251B250	25/5A	0...25A
AN9251B300	30/5A	0...30A
AN9251B400	40/5A	0...40A
AN9251B500	50/5A	0...50A
AN9251B600	60/5A	0...60A
AN9251B700	70/5A	0...70A
AN9251B750	75/5A	0...75A
AN9251B800	80/5A	0...80A
AN9251C100	100/5A	0...100A
AN9251C120	120/5A	0...120A
AN9251C125	125/5A	0...125A
AN9251C150	150/5A	0...150A
AN9251C160	160/5A	0...160A
AN9251C200	200/5A	0...200A
AN9251C250	250/5A	0...250A
AN9251C300	300/5A	0...300A
AN9251C400	400/5A	0...400A
AN9251C500	500/5A	0...500A
AN9251C600	600/5A	0...600A
AN9251C700	700/5A	0...700A
AN9251C750	750/5A	0...750A
AN9251C800	800/5A	0...800A
AN9251D100	1000/5A	0...1000A
AN9251D120	1200/5A	0...1,2kA
AN9251D125	1250/5A	0...1,25kA
AN9251D150	1500/5A	0...1,5kA
AN9251D160	1600/5A	0...1,6kA
AN9251D200	2000/5A	0...2kA
AN9251D250	2500/5A	0...2,5kA
AN9251D300	3000/5A	0...3kA
AN9251D400	4000/5A	0...4kA
AN9251D500	5000/5A	0...5kA
AN9251D600	6000/5A	0...6kA
AN9251D800	8000/5A	0...8kA
AN9251E100	10000/5A	0...10kA

Other executions available
2In overscale: Replace the 6th number (1) of product code with 2
Input from CT/1A: Replace the 5th number (5 or D) of the product code with 1

Cat. Nos.	Alternating current ammeters direct connection	
	Input	Scale
AN92D1A100		0...1A
AN92D1A150		0...1.5A
AN92D1A200		0...2A
AN92D1A250		0...2.5A
AN92D1A300		0...3A
AN92D1A400		0...4A
AN92D1A500		0...5A
AN92D1A600		0...6A
AN92D1B100	direct	0...10A
AN92D1B150		0...15A
AN92D1B200		0...20A
AN92D1B250		0...25A
AN92D1B300		0...30A
AN92D1B400		0...40A
AN92D1B500		0...50A
AN92D1B600		0...60A

Other executions available
2In overscale Replace the 6th number (1) of product code with 2

Cat. Nos.	Alternating voltage voltmeters by VT	
	Direct indication of input voltage or primary voltage of external CT Moving iron equipment Input by external VT /100V - /110V Version for starting motor 2In Scale length 90° Accuracy class 1,5	
	Input	Scale
AN95111111	0...100V	
AN95211111	0...120V	
AN95311111	0...125V	
AN95411111	0...131.58V	note 1
AN95511111	0...133.33V	
AN95611111	0...136.36V	
AN95711111	0...150V	
AN95P11111	other values	note 2

Note 1 - in addition to the Cat. Nos. indicate the scale and the VT ratio. The ladder should correspond to the product of the input value selected and the TV report
Note 2 - in addition to the product code indicate the scale and the VT ratio

Cat. Nos.	Alternating current ammeters direct connection	
	Input	Scale
AN95DDB400		0...40V
AN95DDB600		0...60V
AN95DDC100		0...100V
AN95DDC150		0...150V
AN95DDC200		0...200V
AN95DDC250	direct	0...250V
AN95DDC300		0...300V
AN95DDC400		0...400V
AN95DDC500		0...500V
AN95DDC600		0...600V

Analog indicators

Modular analog meters for direct current and voltage D4M series



Cat. Nos.	Direct current ammeters by shunt c.d.t. 60mV	
	Direct indication of input current or primary current of external shunt Indication of any quantity, directly proportional to signals coming from transducers or sensors Moving coil equipment - Direct connection 1mA...40A Connection by external shunt 1A/60mV...1000A/60mV Connection by transducers or sensors 1...600mA - 0...5/10/20 - 4...20mA Lateral zero or central zero version Live zero or mechanically suppressed (4...20mA) Scale length 90° - Accuracy cl.1,5	
	Input	Scale
AN960A1002	1A-60mV	0...1A
AN960A1502	1.5A-60mV	0...1.5A
AN960A2002	2A-60mV	0...2A
AN960A2502	2.5A-60mV	0...2.5A
AN960A3002	3A-60mV	0...3A
AN960A4002	4A-60mV	0...4A
AN960A5002	5A-60mV	0...5A
AN960A6002	6A-60mV	0...6A
AN960A8002	8A-60mV	0...8A
AN960B1002	10A-60mV	0...10A
AN960B1502	15A-60mV	0...15A
AN960B2002	20A-60mV	0...20A
AN960B2502	25A-60mV	0...25A
AN960B3002	30A-60mV	0...30A
AN960B4002	40A-60mV	0...40A
AN960B5002	50A-60mV	0...50A
AN960B6002	60A-60mV	0...60A
AN960B8002	80A-60mV	0...80A
AN960C1002	100A-60mV	0...100A
AN960C1202	120A-60mV	0...120A
AN960C1502	150A-60mV	0...150A
AN960C2002	200A-60mV	0...200A
AN960C2502	250A-60mV	0...250A
AN960C3002	300A-60mV	0...300A
AN960C4002	400A-60mV	0...400A
AN960C5002	500A-60mV	0...500A
AN960C6002	600A-60mV	0...600A
AN960C8002	800A-60mV	0...800A
AN960D1002	1kA-60mV	0...1000A
AN96SB6001	-...0...60mV	Note 1

Other executions available
Input/central zero scale: Replace the 5th number (0) of the product code with 1

Cat. Nos.	Direct current ammeters direct connection	
	Input	Scale
AN938A1002		0...1A
AN938A2502		0...2.5A
AN938A5002		0...5A
AN938B1002		0...10A
AN938B1502	direct	0...15A
AN938B2002		0...20A
AN938B2502		0...25A
AN938B3002		0...30A
AN938B4002		0...40A

Other executions available
Input/ central zero scale: Replace the 5th number (8) of the product code with 9

Cat. Nos.	Direct current indicators by transducers/sensors	
	Input	Scale
AN932A1001	0...1mA	
AN932A5001	0...5mA	
AN932B1001	0...10mA	
AN932B2001	0...20mA	
AN933A1001	1...0...1mA	Note 1
AN933A5001	5...0...5mA	
AN933B1001	10...0...10mA	
AN933B2001	20...0...20mA	
AN934M0001	4...20mA	
AN935V0001	0...4...20mA	

Cat. Nos.	Direct voltage voltmeters direct connection	
	Direct indication of input voltage Indication of any quantity, directly proportional to signals coming from transducers, sensors or shunt Moving coil equipment Direct connection 10...600V Connection by transducers or sensors 5 - 10V Lateral zero or central zero version Scale length 90° - Accuracy cl.1,5	
	Input	Scale
AN964B1002		0...10V
AN964B1502		0...15V
AN964B2502		0...25V
AN964B3002		0...30V
AN964B4002		0...40V
AN964B6002		0...60V
AN964B8002		0...80V
AN964C1002	direct	0...100V
AN964C1502		0...150V
AN964C2002		0...200V
AN964C2502		0...250V
AN964C3002		0...300V
AN964C4002		0...400V
AN964C5002		0...500V
AN964C6002		0...600V

Other executions available
Input/central zero scale Replace the 5th number (4) of the product code with 5

Cat. Nos.	Direct voltage indicators by transducers/sensors/shunt	
	Input	Scale
AN962B5001	0...50mV	
AN962B6001	0...60mV	
AN962C1001	0...100mV	
AN962C1501	0...150mV	
AN963B5001	50...0...50mV	
AN963B6001	60...0...60mV	
AN963C1001	100...0...100mV	Note 1
AN963C1501	150...0...150mV	
AN964A5001	0...5V	
AN964B1001	0...10V	
AN965A5001	5...0...5V	
AN965B1001	10...0...10V	

Note 1 In addition to the product code indicate the scale corresponding to the input.

Analog indicators

Interchangeable scale for modular analog meters D4E series



Analog indicators

Interchangeable scale for modular analog meters D4M series



Cat. Nos. Interchangeable scale for A.C. ammeters by CT

Cat. Nos.	Input	Scale
SC92D1A500	5/5A	0...5A
SC9251B100	10/5A	0...10A
SC9251B150	15/5A	0...15A
SC9251B200	20/5A	0...20A
SC9251B250	25/5A	0...25A
SC9251B300	30/5A	0...30A
SC9251B400	40/5A	0...40A
SC9251B500	50/5A	0...50A
SC9251B600	60/5A	0...60A
SC9251B700	70/5A	0...70A
SC9251B750	75/5A	0...75A
SC9251B800	80/5A	0...80A
SC9251C100	100/5A	0...100A
SC9251C120	120/5A	0...120A
SC9251C125	125/5A	0...125A
SC9251C150	150/5A	0...150A
SC9251C160	160/5A	0...160A
SC9251C200	200/5A	0...200A
SC9251C250	250/5A	0...250A
SC9251C300	300/5A	0...300A
SC9251C400	400/5A	0...400A
SC9251C500	500/5A	0...500A
SC9251C600	600/5A	0...600A
SC9251C700	700/5A	0...700A
SC9251C750	750/5A	0...750A
SC9251C800	800/5A	0...800A
SC9251D100	1000/5A	0...1000A
SC9251D120	1200/5A	0...1200A
SC9251D125	1250/5A	0...1250A
SC9251D150	1500/5A	0...1500A
SC9251D160	1600/5A	0...1600A
SC9251D200	2000/5A	0...2000A
SC9251D250	2500/5A	0...2500A
SC9251D300	3000/5A	0...3000A
SC9251D400	4000/5A	0...4000A
SC9251D500	5000/5A	0...5000A
SC9251D600	6000/5A	0...6000A
SC9251D700	7000/5A	0...7000A
SC9251D750	7500/5A	0...7500A
SC9251D800	8000/5A	0...8000A
SC9251E100	10000/5A	0...10000A

Other executions available

2In overscale: Replace the 6th number (1) of product code with 2

Input from CT/1A: Replace the 5th number (5 or D) of the product code with 1





Cat. Nos. Interchangeable scale for direct voltage and current indicators by transducers/sensors/shunt

Cat. Nos.	Input	Scale
SC930L0000	various in dc	
SC934M0000	4...20mA	Note 1
SC935V0000	0...4...20mA	

Note 1 In addition to the product code indicate the scale corresponding to the input

Analog indicators

Flush mounting analog meters with alarms AL96 series

	ALTERNATING CURRENT (AC)		DIRECT CURRENT (DC)		ALTERNATING CURRENT (AC)	DIRECT CURRENT (DC)
 AL96 - 96x96mm						
Type	Ammeters	Voltmeters	Ammeters	Voltmeters	Insulator meter	Insulator meter
Technical notes	NT475	NT476	NT477	NT476	NT481	NT482
DISPLAY						
Scale length	90°					
Standard scale marking	0...In	0...Un	0...In	0...Un	∞...5...0.5MΩ...0 ∞...2...0.2MΩ...0	∞...2...0.2...0MΩ ∞...200...20...0kΩ
INPUT						
Connection	by external CT /5A or /1A	direct or by external VT/100V	direct	direct or from external shunt	by external accessory and VaT/100V	by external accessory
Rating current In	5A or 1A	-	1 - 5 - 10 - 20 - 4...20mA	-	-	-
Rating voltage Un	-	100 - 300 - 500V	-	60mV...200V	690/100V	24 - 120 - 220Vdc
Measure	average value measurement with display related to rms value		-	-	∞...5...0.5MΩ...0 ∞...2...0.2MΩ...0	∞...2...0.2...0MΩ ∞...200...20...0kΩ
Max. test current (Rg=0)	-		-	-	50μA (5MΩ) - 120μA (2MΩ)	120μA (2MΩ) - 1,2μA (200kΩ)
Rated frequency	50 Hz		-	-	50 Hz	-
Working frequency	47...63Hz		-	-	47...63Hz	-
Continuous overload	1,2In	1,2Un	1,2In	1,2Un	1,2In	-
Instantaneous overload	5In/5s	-	5In/5s	-	5In/5s	-
Rated burden	≤ 0,25VA (In=1A) - ≤ 0,5VA (In=5A)	-	-	-	≤ 0,25VA (In=1A) - ≤ 0,5VA (In=5A)	-
Input impedance	-	> 200kΩ (Un=100V) - ≥ 1MΩ (Un=500V)	-	-	-	-
Voltage drop	-	-	≤ 100mV	-	-	-
OUTPUT						
Type	2 relays with SPDT contacts, potential free					
Contacts range	230V 4A cosφ 0,4 - 24V 4Adc					
Programmables alarms	2 (MIN+MAX or MIN1+MIN2 or MAX1+MAX2)					
AUXILIARY SUPPLY						
Rated value Uaux ac	115 - 230 - 240V					
Tolerance	±10% Uaux					
Rated frequency	± 50%Hz					
Working frequency	47...63Hz					
Rated burden	≤ 3VA					
ENVIRONMENTAL CONDITIONS						
Nominal temperature range	5...40°C					
Limit range for storage and transport	-40...70°C					
Suitable for tropical climates	yes					
Max. power dissipation	≤ 2.5W					
MECHANICAL FEATURES						
Housing	flush mounting (panel cutout 92x92mm)					
Front frame	96x96mm (99x99mm with IP54 protection)					
Depth	103mm					
Connections	faston 6,3x0,8mm					
Housing material	self-extinguishing polycarbonate					
Protection degree (EN/IEC 60529)	IP50 (front frame) IP20 (terminals) Option IP54 protection degree (with kit ADGIP549)					
Weight	450 grams					

Wiring diagrams

Ammeter/Voltmeter

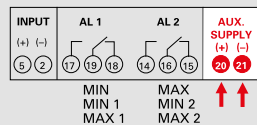

Alternating current

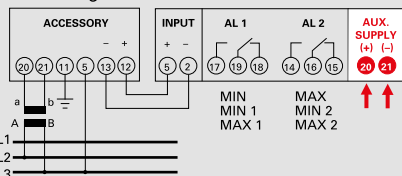

Direct current

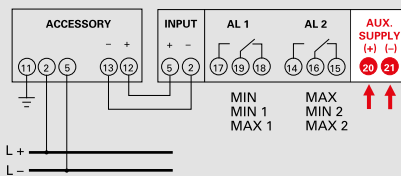

Dimensions

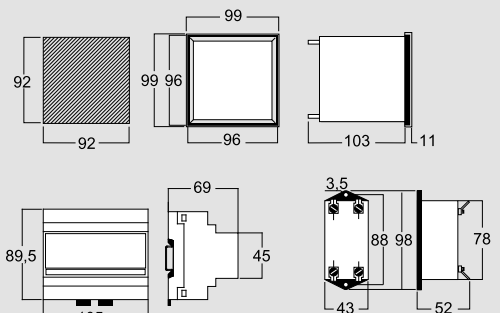

Analog indicators

Flush mounting analog meters with alarms for alternating current and voltage AL96 series



AL96AC - 96x96mm



AL96AC - 96x96mm

Cat. Nos.

Alternating current ammeter by CT

Measurement with display related to rms value
 Input from CT/1A or /5A
 Indication of primary current of external CT
 2 programmables alarms, programmable thresholds 41 led bar on 90° arc
 Accuracy cl.1,5

Cat. Nos.

Alternating voltage voltmeter direct or by VT

Measurement with display related to rms value
 Direct input up to 500V or by VT/100V
 Indication of primary current of external VT
 2 programmables alarms, programmable thresholds 41 led bar on 90° arc
 Accuracy cl.1,5

Input	Scale	Alarm type	Auxiliary
ANT151A50033	5/5A		
ANT151B10033	10/5A		
ANT151B15033	15/5A		
ANT151B20033	20/5A		
ANT151B25033	25/5A		
ANT151B30033	30/5A		
ANT151B40033	40/5A		
ANT151B50033	50/5A		
ANT151B60033	60/5A		
ANT151B70033	70/5A		
ANT151B75033	75/5A		
ANT151B80033	80/5A		
ANT151C10033	100/5A		
ANT151C12033	120/5A		
ANT151C12533	125/5A		
ANT151C15033	150/5A		
ANT151C16033	160/5A		
ANT151C20033	200/5A		
ANT151C25033	250/5A		
ANT151C30033	300/5A	Min and Max	230Vac
ANT151C40033	400/5A		
ANT151C50033	500/5A		
ANT151C60033	600/5A		
ANT151C70033	700/5A		
ANT151C75033	750/5A		
ANT151C80033	800/5A		
ANT151D10033	1000/5A		
ANT151D12033	1200/5A		
ANT151D12533	1250/5A		
ANT151D15033	1500/5A		
ANT151D16033	1600/5A		
ANT151D20033	2000/5A		
ANT151D25033	2500/5A		
ANT151D30033	3000/5A		
ANT151D40033	4000/5A		
ANT151D50033	5000/5A		
ANT151D60033	6000/5A		
ANT151D80033	8000/5A		
ANT151E10033	10000/5A		

Input	Scale	Alarm type	Auxiliary
ANT4DDC30032	Direct		115Vac
ANT4DDC30033	Direct		230Vac
ANT4DDC50032	Direct		115Vac
ANT4DDC50033	Direct	Min and Max	230Vac
ANT4PP111132	from VT	Note 1	115Vac
ANT4PP111133	from VT	Note 1	230Vac

Other executions available

2 max alarms: Replace the 11th number of product code with 4
2 min alarms: Replace the 11th number of product code with 6

Analog indicators

Flush mounting analog meters with alarms for direct current and voltage AL96 series



AL96DC - 96x96mm



AL96DC - 96x96mm

Cat. Nos.	Direct current ammeter unidirectional by transducers/field sensors			
	Direct current measurement Display any proportional process variable Input for standard signal 1 - 5 - 10 - 20 - 4...20mA 2 programmables alarms, programmable thresholds 41 led bar on 90° arc Accuracy cl.1,5			
	Input	Scale	Alarm type	Auxiliary
ANT31132	0...1mA			115Vac
ANT31133	0...1mA			230Vac
ANT32132	0...5mA			115Vac
ANT32133	0...5mA			230Vac
ANT33132	0...10mA	Note 2	Min and Max	115Vac
ANT33133	0...10mA			230Vac
ANT34132	0...20mA			115Vac
ANT34133	0...20mA			230Vac
ANT35132	4...20mA			115Vac
ANT35133	4...20mA			230Vac

Cat. Nos.	Direct voltage voltmeter unidirectional direct or by transducers/field sensors			
	Direct voltage measurement Display any proportional process variable Speed from tachometer dynamo measurement Direct input 1...200V Indication of primary current of external shunt 2 programmables alarms, programmable thresholds 41 led bar on 90° arc Accuracy cl.1,5			
	Input	Scale	Alarm type	Auxiliary
ANT6P132	0...60mV <>200V	Note 2	Min and Max	115Vac
ANT6P133			Min and Max	230Vac
ANT6P142			2 Max	115Vac
ANT6P143			2 Max	230Vac
ANT6P162			2 Min	115Vac
ANT6P163			2 Min	230Vac

Note 2 In addition to the product code indicate the scale corresponding to the input

Other executions available

- 2 max alarms** Replace the 7th number of product code with 4
- 2 min alarms** Replace the 7th number of product code with 6

Analog indicators

Flush mounting A.C. insulation meter AL96 series



AL96MI - 96x96mm

Analog indicators

Flush mounting D.C. insulation meter AL96 series



AL96MI - 96x96mm

Cat. Nos. **A.C. insulation meter for IT networks**

Continuous control insulation towards ground
 Connection on ac network up to 690/100V
 Measuring range 2MΩ or 5MΩ
 Complete with accessory
 2 programmables alarms, programmable thresholds 41 led bar on 90° arc
 Accuracy cl.1,5

Cat. Nos.	Input	Scale	Alarm type	Auxiliary
ANTN1131	up to 690Vac	∞...5MΩ...0	High/low	110Vac
ANTN1132			High/low	115Vac
ANTN1133			High/low	230Vac
ANTN1141			2 Low	110Vac
ANTN1142			2 Low	115Vac
ANTN1143			2 Low	230Vac
ANTN1231	up to 690Vac	∞...2MΩ...0	High/low	110Vac
ANTN1232			High/low	115Vac
ANTN1233			High/low	230Vac
ANTN1241			2 Low	110Vac
ANTN1242			2 Low	115Vac
ANTN1243			2 Low	230Vac

Cat. Nos. **D.C. insulation meter for IT networks**

Continuous control insulation towards ground
 Connection on dc network up to 220V
 Measuring range 200kΩ or 2MΩ
 Complete with accessory
 2 programmables alarms, programmable thresholds 41 led bar on 90° arc
 Accuracy cl.1,5

Cat. Nos.	Input	Scale	Alarm type	Auxiliary
ANTN2232	24Vdc	∞...2MΩ...0	High/low	115Vac
ANTN2233			High/low	230Vac
ANTN2242			2 Low	115Vac
ANTN2243			2 Low	230Vac
ANTN2332			High/low	115Vac
ANTN2333	24Vdc	∞...200kΩ...0	High/low	230Vac
ANTN2342			2 Low	115Vac
ANTN2343			2 Low	230Vac
ANTN3232	120Vdc	∞...2MΩ...0	High/low	115Vac
ANTN3233			High/low	230Vac
ANTN3242			2 Low	115Vac
ANTN3243			2 Low	230Vac
ANTN3332			High/low	115Vac
ANTN3333			High/low	230Vac
ANTN3342			2 Low	115Vac
ANTN3343	2 Low	230Vac		
ANTN4232	220Vdc	∞...2MΩ...0	High/low	115Vac
ANTN4233			High/low	230Vac
ANTN4242			2 Low	115Vac
ANTN4243			2 Low	230Vac
ANTN4332			High/low	115Vac
ANTN4333			High/low	230Vac
ANTN4342			2 Low	115Vac
ANTN4343	2 Low	230Vac		

Analog indicators

Flush mounting double synchronizing meters SYNCRO 96DF - 96DV series



Syncro 96DF - 96x96mm



Syncro 96DV - 96x96mm

Cat. Nos.

Syncro 96DF double frequencymeter direct or by VT

2 independent side-by-side meters for an immediate comparison of the frequencies to be synchronized line and generator
 Moving coil equipment
 Direct connection up to 440V or with VT /100V or /110V
 Rating frequency 50 and 60Hz
 Accuracy class 0,5

	Input	Alarm type	Auxiliary
ANRDF11	110-115Vac	45...55Hz	50Hz
ANRDF13	230-240Vac	45...55Hz	50Hz
ANRDF14	400-440Vac	45...55Hz	50Hz
ANRDF31	110-115Vac	55...65Hz	60Hz
ANRDF33	230-240Vac	55...65Hz	60Hz
ANRDF34	400-440Vac	55...65Hz	60Hz

Cat. Nos.

Syncro 96DV double voltmeter direct or by VT

2 independent side-by-side meters for an immediate comparison of the voltages to be synchronized line and generator
 Moving coil equipment, with rectifier
 Direct connection up to 600V or by VT /100V or /110V
 Rating frequency 50 and 60Hz
 Accuracy class 1,5

	Input	Alarm type	Auxiliary
ANRDV11	100V=100%	0...120%	50-60Hz
ANRDV12	100V=100%	0...120%	50-60Hz
ANRDV53	direct	0...300V	50-60Hz
ANRDV23	direct	0...500V	50-60Hz
ANRDV33	direct	0...600V	50-60Hz
ANRDV24	400/100V	0...500V	50-60Hz
ANRDV25	400/100V	0...500V	50-60Hz
ANRDV34	400/100V	0...600V	50-60Hz
ANRDV35	400/100V	0...600V	50-60Hz
ANRDV48	690/100V	0...900V	50-60Hz
ANRDVPP	other ratios	Note 1	50-60Hz

note 1: in addition to the product code pls. indicate the scale and the VT ratio

Analog indicators

Flush mounting double synchronizing meters SYNCRO 96DF - 96DV series

Technical features

MODEL	FREQUENCY METER	VOLTMETER
TECHNICAL NOTES	NT800	NT801
DISPLAY		
Scale length	90°	
INPUT		
Connection	direct or by external VT	
Rating voltage Un (direct)	230-240 or 400-440V	300 - 500 - 600V
Rating voltage Un (by external VT)	/100V - /110V	
Measure	Frequency	average value measurement, related to r.m.s. value, form factor 1,11
Rated frequency	50-60 Hz	-
Working frequency	45...55Hz (fn 50Hz) - 55...65Hz (fn 60Hz)	47...63Hz
Rated burden	2VA (referred each input 100V)	1,5VA (referred to each input 100V)
Accuracy (EN/IEC 60051)	cl. 0,5	cl. 1,5
INSULATION (EN/IEC 61010-1)		
Installation category	III	
Pollution degree	2	
A.C. voltage test (all circuits and earth)	4kV r.m.s. 50Hz/5s	
ENVIRONMENTAL CONDITIONS		
Nominal temperature range	5...40°C	
Limit range for storage and transport	-40...80°C	
Vibration test according to	EN/IEC 60051-1 paragraph 7.6	
Shock test according to	EN/IEC 60051-1 paragraph 7.6	
MECHANICAL FEATURES		
Housing	flush mounting (panel cutout 92x92mm)	
Front frame	96x96mm (99x99mm with IP54 protection)	
Depth	124mm	
Connections	threaded terminals with M4 nut	
Housing material	self-extinguishing polycarbonate	
Protection degree (EN/IEC 60529)	IP52 (front frame) IP20 (terminals) Option IP54 front frame)	

Dimensions

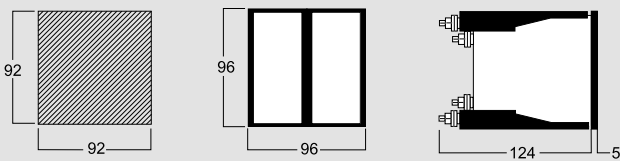

Wiring diagrams

Frequency meter

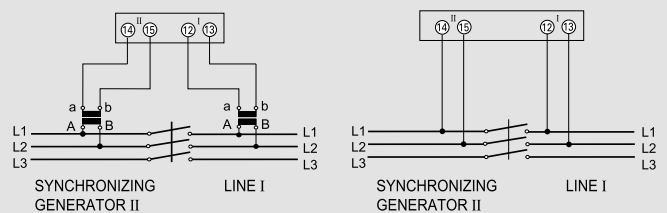

Voltmeter

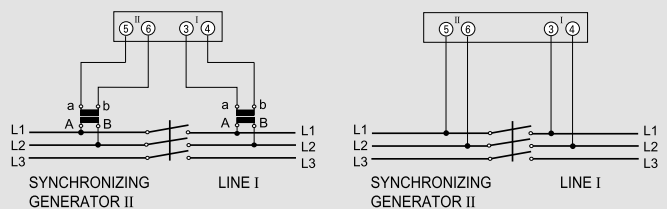

Analog indicators

Flush mounting synchronizing meters **SYNCR0 96 FD/DV/Z series**



Syncro 96FD
96x96mm



Syncro 96VD
96x96mm



Syncro 96Z
96x96mm

Cat. Nos. **Syncro 96FD - Differential frequencymeter by VT**

Indication of percentage difference between the 2 frequencies to be synchronized line and generator
Moving coil equipment, with 2 separate transducer
Accuracy class 1,5

	Input	Scale	Frequency
ANRFD11	100V	20...0...20Hz%	50Hz
ANRFD12	110-115Vac	20...0...20Hz%	50Hz
ANRFD31	100V	20...0...20Hz%	60Hz
ANRFD32	110-115Vac	20...0...20Hz%	60Hz

Cat. Nos. **Syncro 96VD - Differential voltmeter by VT**

Indication of percentage difference between the 2 voltages to be synchronized line and generator
Moving coil equipment, with 2 separate transducer
Accuracy class 1,5

	Input	Scale	Frequency
ANRVD1	100V	20...0...20Vn%	50-60Hz
ANRVD2	110V	20...0...20Vn%	50-60Hz

Cat. Nos. **Syncro 96Z - Nullvoltmeter by VT**

Indication of the difference between the 2 voltages to be synchronized line and generator
Moving coil equipment, with rectifier
Accuracy class 1,5

	Input	Scale	Frequency
ANRG1	100V	0...50V	50-60Hz

Analog indicators

Flush mounting synchronizing meters **LED SYNCR0 96 L/C series**



Syncro 96L
96x96mm



Syncro 96C
96x96mm

Cat. Nos. **Syncro 96L - LED synchronoscope direct or by VT**

16 red LED on 360°
They measure the phase difference ($\Delta\Phi$) between a generator and the network, showing its condition (lead or lag) until the synchronicity situation (phase displacement $\Delta\Phi=0^\circ$) is reached.
They report the possible phase opposition condition (phase displacement $\Delta\Phi=180^\circ$).

	Input	Frequency
ANRJ1	100-115V	50-60Hz
ANRJ2	230-240V	50-60Hz
ANRJ3	400-440V	50-60Hz

Cat. Nos. **Syncro 96C - LED synchronoscope with synchronizing output relay**

LED synchronoscope with synchronizing output relay (19 red LED on 360° + LED display for phase angle, voltage and frequency line/generator, voltage difference and frequency), direct or connection on voltage transformers
Measure and display synchronism parameters
Voltage difference percentage
Frequency difference percentage
Phase angle

	Input	Auxiliary	Frequency
ANTJ11	30...150V	18...36Vdc	35...80Hz
ANTJ21	30...150V	95...126Vac	35...80Hz
ANTJ10	110...620V	18...36Vdc	35...80Hz
ANTJ30	110...620V	360...440Vac	35...80Hz

Technical features

MODEL	96FD	96DV	96Z	96L	96C
TECHNICAL NOTES	NT802	NT803	NT805	NT804	NT595
DISPLAY					
Scale length	90°			360°	-
Standard scale marking	20...0...20% ΔHzn	20...0...20% ΔVn	0...50V		
INPUT					
Connection	2 independent inputs with external transducer accessory			direct or by VT	-
Rating voltage Un (direct)	100-110Vac			100-115V 230-240V 400-440V	-
Rating voltage Un (by VT)	/100V - /110V			-	-
Measure	Frequency	average value measurement, related to r.m.s. value, form factor 1,11			30...150V - 110...620V
Rated frequency	50-60 Hz				35...80Hz
Working frequency	20...0...20% ΔHzn	47...63Hz			
Rated burden	≤ 5,5VA	≤ 2,5VA	≤ 0,2VA	3VA (100V)	< 500μA
Accuracy (EN/IEC 60051)	cl. 1.5				
ENVIRONMENTAL CONDITIONS					
Nominal temperature range	-25...50°C			-5...55°C	-10...65°C
Limit range for storage and transport	-40...80°C				-40...70°C
Vibration test according to	EN/IEC 60051-1 paragraph 7.6				
Shock test according to	EN/IEC 60051-1 paragraph 7.6				
MECHANICAL FEATURES					
Housing	flush mounting (panel cutout 92x92mm)				
Front frame	96x96mm (99x99mm with IP54 protection)				
Depth	84mm			105mm	81.5mm
Connections	threaded terminals with M4 nut			screw terminals / fast-on 6,3x0,8mm	
Housing material	self-extinguishing polycarbonate			self-extinguishing ABS	
Protection degree (EN/IEC 60529)	IP52 (front frame) IP20 (terminals) Option IP54 front frame)				

Dimensions

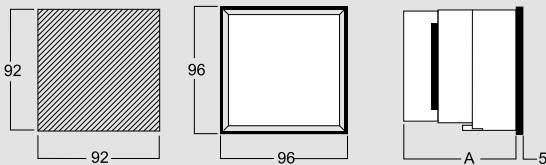

	A
96FD/VD/Z	84
96L	105
96C	81.5

Wiring diagrams

Syncro 96FD

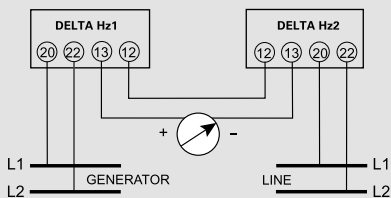

Syncro 96Z

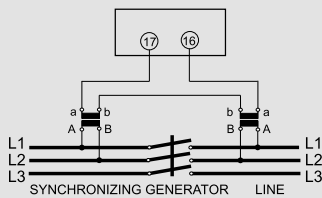

Syncro 96DV

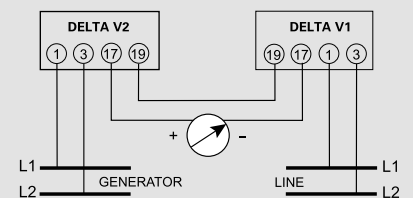

Syncro 96C

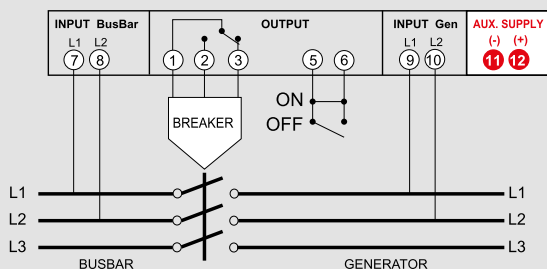

Syncro 96L

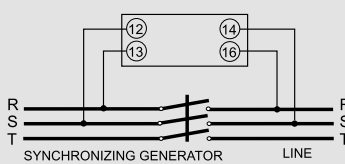

Syncro 96L

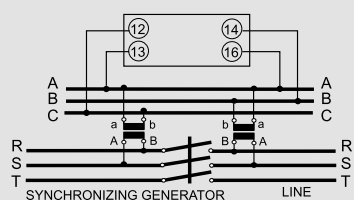

Analog indicators

Correct phase sequence indication and phase loss warning



ANQB1
72x72mm



ANRB1
96x96mm



AN9B1

Cat. Nos.	RQ72SE	
	Flush mounting LED sequencymeter 72X72mm	
	Input	Frequency
ANQB1	100...440V	50Hz

Cat. Nos.	RQ96SE	
	Flush mounting LED sequencymeter 96X96mm	
	Input	Frequency
ANRB1	100...440V	50-60Hz

Cat. Nos.	D4SE	
	Modular LED sequencymeter	
	Input	Frequency
AN9B1	100...440V	50-60Hz

Technical features

MODEL	RQ72SE	RQ96SE	D4SE
TECHNICAL NOTES	NT806	NT806	NT807
DISPLAY			
Type	red LED's		
Phase presence	LED "L1-L2-L3" on		
Correct cyclic sequence	"CORRECT" LED on		
Wrong cyclic sequence	"INCORRECT" LED on		
Phase failure	"CORRECT and INCORRECT" LED's contemporaneously on with turning off of LED corresponding to failing phase (L1 or L2 or L3)		
INPUT			
Line voltage Un	100...440V		
Rating frequency	50-60Hz		
Working frequency	47...63Hz		
Rated burden	≤ 2VA		
ENVIRONMENTAL CONDITIONS			
Reference temperature	23°C		
Operating range	-25...50°C		
Limit range for storage and transport	-40...80°C		
Vibration test according to	EN/IEC 60051-1 paragraph 7.6		
Shock test according to	EN/IEC 60051-1 paragraph 7.6		
MECHANICAL FEATURES			
Housing	flush mounting (panel cutout 68x68mm)	flush mounting (panel cutout 92x92mm)	4 modules DIN43880 (35mm)
Connections	screw terminal / fast-on 6,3x0,8mm		screw terminal cable up to 4mm ²
Housing material	self-extinguishing polycarbonate		
Protection degree (EN/IEC 60529)	IP52 (front frame) IP20 (terminals) Option IP54 front frame	IP50 (front frame) IP20 (terminals)	

Analog indicators

Hourmeters



Cat. Nos.			Flush mounting hourmeters		
			7 digits mechanical numerator (resolution depending on the supply voltage) It counts the total working time for machines, motors or any electrical device. Counting of working times allows to program maintenance interventions, to survey costs, to check the guarantee terms. Time counting in hours and hundredths of hour Maximum display 99.999,99 (aux. ac) – 999.999,9 (aux. dc) Auxiliary supply dc 10...80 - 110Vdc Technical notes NT777- NT779- NT779		
RQ480	RQ720	RQ960	Voltage	Frequency	Scale
ANPA1	ANQA1	ANRA1	100-115V	50Hz	00000.00h
ANPA3	ANQA3	ANRA3	230-240V	50Hz	
ANPA5	ANQA5	ANRA5	400-415V	50Hz	
ANPA6	ANQA6	ANRA6	24V	50Hz	
ANPA7	ANQA7	ANRA7	48V	50Hz	
ANPA2	ANQA2	ANRA2	100-115V	60Hz	
ANPA4	ANQA4	ANRA4	230-240V	60Hz	
ANPAV	-	-	24V	60Hz	
ANPA8	ANQA8	ANRA8	10...80V	dc	
ANPA9	ANQA9	ANRA9	110V	dc	

Cat. Nos.		Flush mounting hourmeters		
		7 digits mechanical numerator (resolution depending on the supply voltage) It counts the total working time for machines, motors or any electrical device. Counting of working times allows to program maintenance interventions, to survey costs, to check the guarantee terms. Time counting in hours and hundredths of hour Maximum display 99.999,99 Auxiliary supply 100...115 – 230...240Vac Technical notes NT776- NT788		
R360	C580	Voltage	Frequency	Scale
ANXA3	-	230-240V	50Hz	00000.00h
ANXA6	-	24V	50Hz	
-	ANZA8	10...80V	dc	
ANXAV	-	24V	60Hz	

Cat. Nos.		Modular hourmeters		
		7 digits mechanical numerator (resolution depending on the supply voltage) It counts the total working time for machines, motors or any electrical device. Counting of working times allows to program maintenance interventions, to survey costs, to check the guarantee terms. Time counting in hours and hundredths of hour Maximum display 99.999,99 Auxiliary supply 100...115 – 230...240Vac Technical notes NT780		
D20	Voltage	Frequency	Scale	
ANYA1	100-115V	50Hz	00000.00h	
ANYA3	230-240V	50Hz		
ANYA6	24V	50Hz		
ANYAV	24V	60Hz		

Analog indicators

3-phase switches



Cat. Nos.		C48 Flush mounting switches	
		Amperometric and Voltmetric switches They allow to use only one meter to measure, by scanning, the linked and phase voltages or the currents in a three-phase system Technical notes NT749	
		Description	
AV104		amperometric single-pole to 3 gears (12A-690V)	
AV105		voltmeter for 3 voltages (12A-690V)	
AV106		voltmeter for 3 phase voltages, 3 phase-neutral (12A-690V)	
Cat. Nos.		CD3 Modular switches	
		Amperometric and Voltmetric switches They allow to use only one meter to measure, by scanning, the linked and phase voltages or the currents in a three-phase system Technical notes NT750	
		Description	
AV114		amperometric single-pole to 3 gears (12A-690V)	
AV115		voltmeter for 3 voltages (12A-690V)	
AV116		voltmeter for 3 phase voltages, 3 phase-neutral (12A-690V)	



IME

Via Travaglia, 7
20094 Corsico (MI)
☎ : +39 02 44 878.1
Fax +39 02 45 03 448
info@imeitaly.com
www.imeitaly.com